



VENT-FREE FIREBOX

Breckenridge Premium VFP32FB

Spec Sheet



ACTUAL DIMENSIONS

34 1/4" W x 38 1/16" H x 20 7/16" D

INCLUDES

- Junction Box
- Standard Hood

REQUIRES

- Burner
- Log Set
- Extended Hoods for installation where the firebox surround materials are thicker than 1-inch
- Mantel requires 3-piece Outer Frame Kit

TECHNICAL INFORMATION

- Weight: 95 lbs.
- Flush Front or Louver

FIELD INSTALLED ACCESSORIES

- Liners: Aged Brick, Banded Brick, Stacked Limestone, Traditional Brick
- Ember Kit
- Blower
- Fresh Air Kit
- Light Kit, 120 V
- Decorative Hood: Hammered Pewter, Matte Black, Stainless Steel,
- Decorative Louvers: Mission or Arch (Hammered Pewter or Matte Black)
- Decorative Arch Door Set: Mission Arch or regular Arch in Hammered Pewter or Matte Black
- Outer Steel Frame, Hammered Pewter or Matte Black

VFP32FB

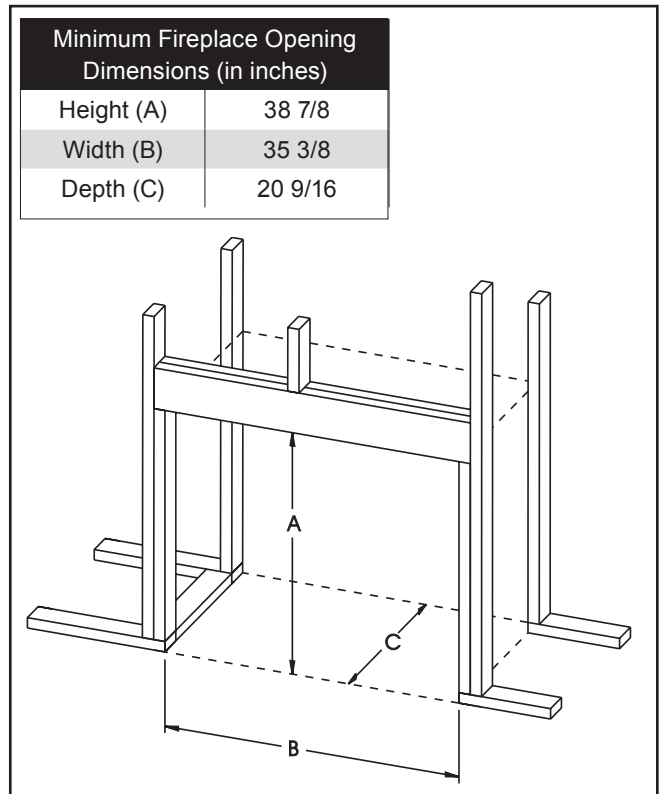
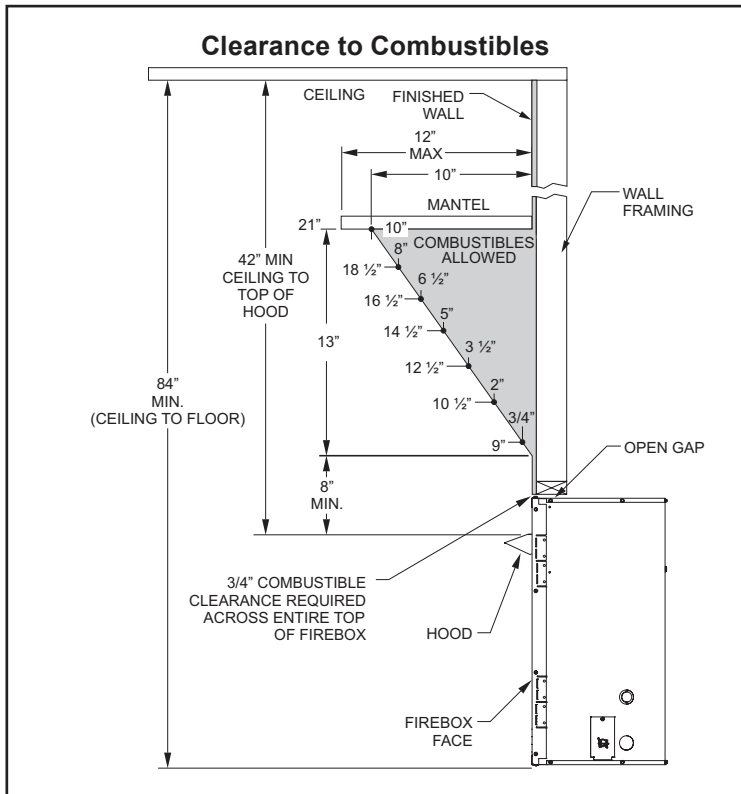
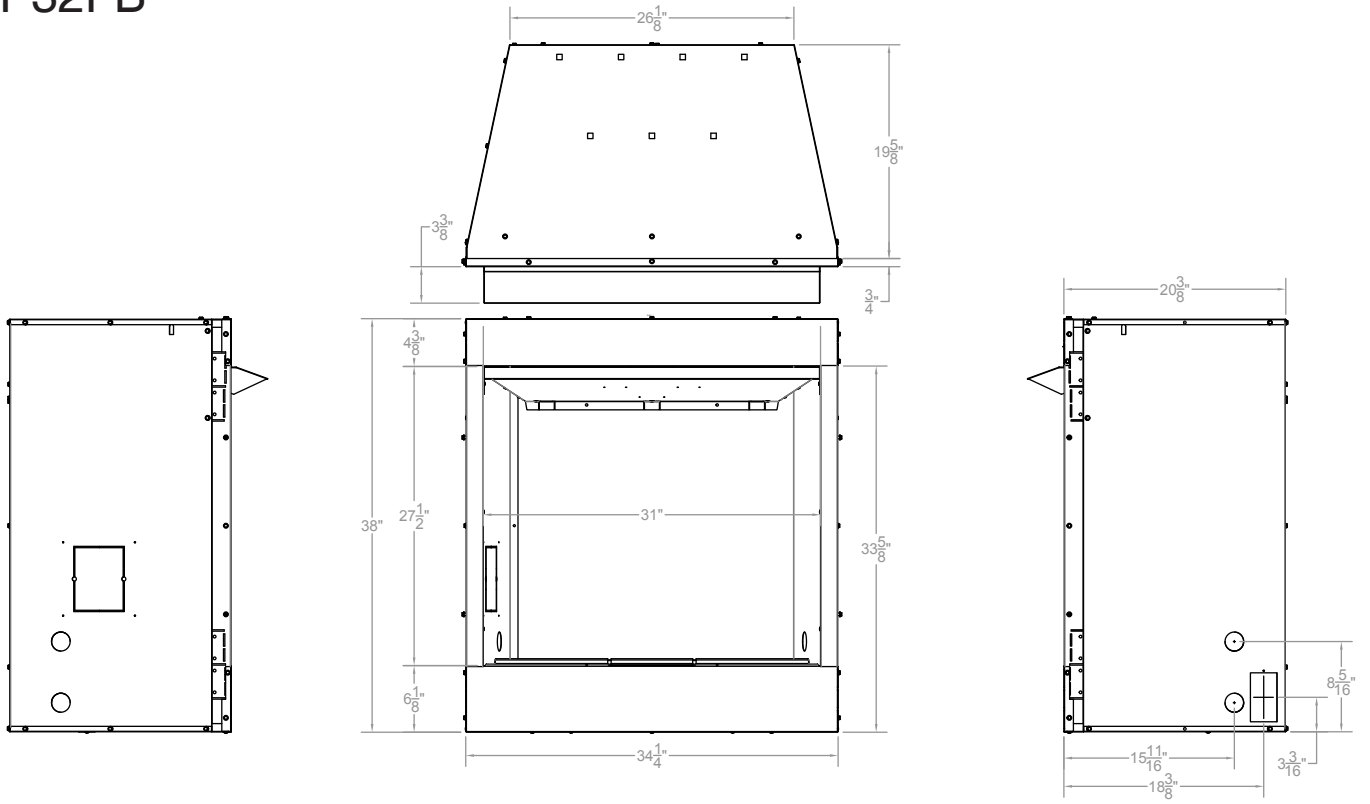

Empire is committed to continuous product improvement; specifications are subject to change without notice. Dimensions in this brochure are approximate; read and follow the framing dimensions in the owners manual supplied with your Empire product. Flame size, shape, and color will vary from photos. Our mantels feature natural veneers and hand-rubbed finishes – wood grain and color will vary. Adjust light levels and use "natural light" incandescent bulbs to enhance the dramatic look for your wooden mantel.

Member of the following industry associations:

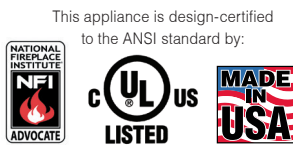

SINCE 1932
 Empire Comfort Systems Inc.
 918 Freeburg Ave.
 Belleville, IL 62220-2623
 info@empirecomfort.com
 01/18

The Empire Comfort Systems and White Mountain Hearth names and logos are registered U.S. trademarks.