



BEYOND FIRE



*Wood & Pellet Stoves
Wood Inserts & Fireplaces.*

*High Quality & Unique
Design For Your Comfort.*



PRODUCT SHOWN : **OSBURN 2300** (OB02302)

PRODUCT SHOWN : **OSBURN 3000** (OP0030)



new

PELLET STOVES

» SEE PAGES
32 AND 34

www.osburn-mfg.com

BEYOND FIRE

BEYOND... A single word that captures our philosophy and commitment at Osburn. This is our source of inspiration.

What does "BEYOND" mean to Osburn?

BEYOND drives us forward when we look at products. We go beyond with what we do and with our interactions in life. It is more than building and selling products. It's no longer about just doing, but doing with a purpose, doing efficiently. It is about exceeding expectations. BEYOND... drives us to do better, to be more functional and achieve higher performance. We believe great products define a great appliance manufacturer. We are not afraid to take the lead or to stretch the boundaries. When you go BEYOND..., you simply go ahead; you look at the present and envision amazing things happening for the future. That's who we are, our philosophy. Our hope is to share it with you and we invite you to take the time to discover how we go beyond.

The Osburn Team



Aspen
*Southern Ledge*stone
CULTURED STONE®
BY BORAL®

OSBURN
PROUD PARTNER OF

CANADIAN
STONE

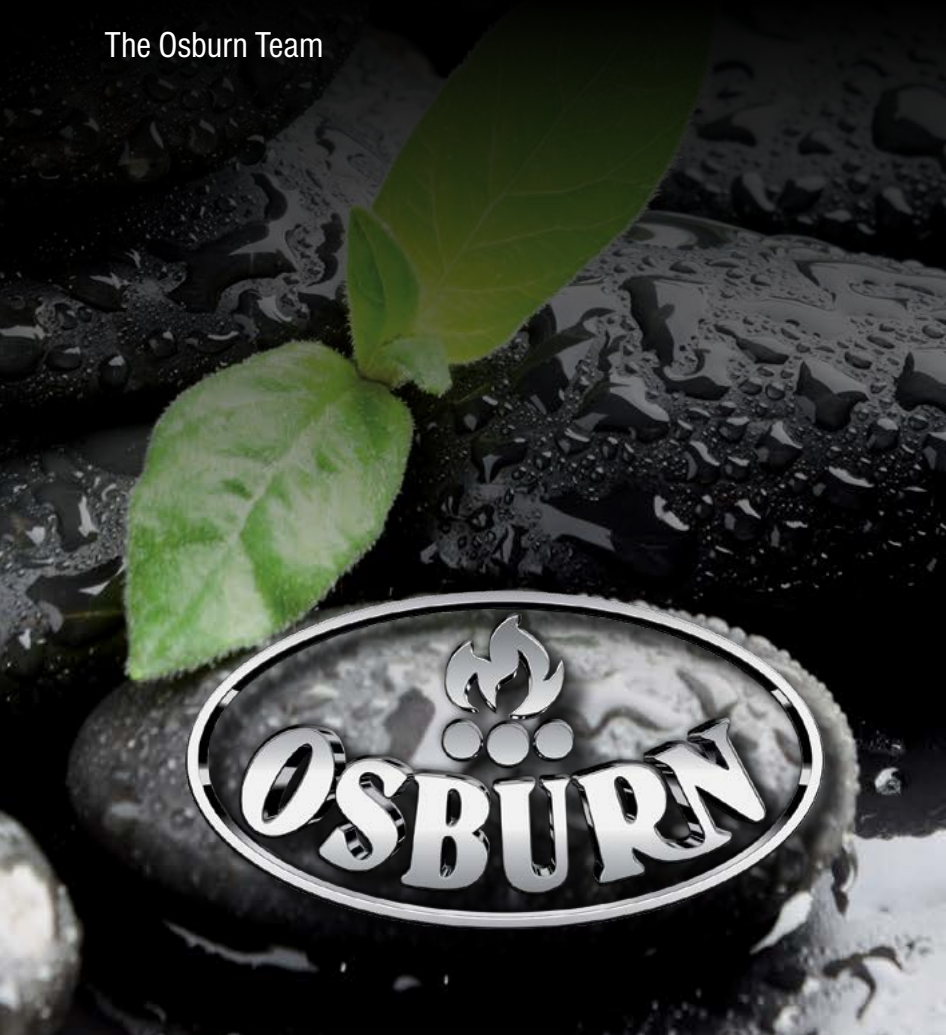

Images in this catalog are
for reference only.

SUMMARY



Wood heating and the environment	4
Wood stoves	
900	5
Soho	6
1600	7
2000	8
Matrix	9
2200	10
2300	11
2400	12
Features, technical data and clearances	13
Wood inserts	
1100	15
1600	16
1800	17
2000	18
Matrix	19
2200	20
2400	21
Features, technical data and clearances	22
Zero clearance wood fireplace	
Stratford	24
Everest	25
Horizon	26
Features, technical data and clearances	27
Pellet Stoves	
2500 - NEW	32
3000 - NEW	34
Volta	36
5000	38
7000	40
	33
	35
Features, technical data and clearances	37
	39
	41
Accessories	
Osburn Limited Lifetime Warranty on Robax ceramic glass	43

WOOD HEATING AND THE ENVIRONMENT

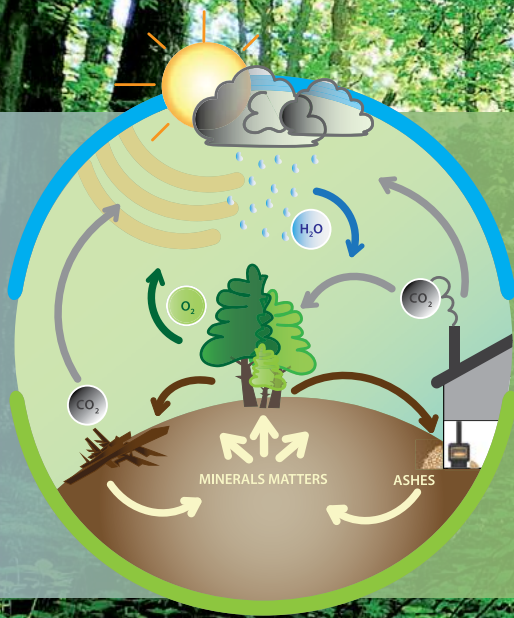

When oil, gas, and coal are burned, the carbon they contain is oxidized to carbon dioxide (CO₂), the main greenhouse gas. In effect, the combustion of fossil fuels releases ancient carbon (carbon that has been buried within the earth for thousands of years), thereby increasing the atmospheric concentration of carbon dioxide (CO₂). In comparison, wood combustion can be considered carbon neutral because trees absorb CO₂ as they grow. This process is called carbon sequestration.

Approximately one ton of carbon is sequestered for each cubic meter of wood. When trees mature, die, fall in the forest and decompose, the same amount of carbon is emitted as would be released if they were burned for heat. This cycle can be repeated forever without increasing atmospheric carbon. A healthy forest is not a museum, but a living community of plants and animals. When trees are used for energy, a part of the forests carbon "bank" is diverted from the natural decay and forest cycle into our homes to heat them.

When we heat with wood, we are simply tapping into the natural carbon cycle in which CO₂ flows from the atmosphere to the forest and back. The key to ecologically sound and sustainable wood energy use is to ensure that the forest remains healthy, maintains a stable level of variously aged trees and provides a good habitat for a diversity of other species, both plants and animals. Ensuring there is a healthy fuelwood market is key to a sustainable forestry plan. Landowners have more incentive to remove low value trees and manage their forests sustainably knowing there is a market for this low value material.

The combustion of wood produces small particles that are called PM_{2.5}. Those particles are 30 times smaller than a human hair. They can aggravate certain lung and heart diseases and have been linked with health problems such as asthma. Sources of PM_{2.5} include combustion under various forms, such as the one used for cars and trucks, wood heating, as well as other industrial processes. While it is true that old technology like open fireplaces and simple heaters could not burn the wood completely, the new generation of wood-burning appliances are designed to burn particles. They produce almost no visible smoke. The wood heating industry has evolved. The vast majority of appliances sold on the market now meet the particles emissions limits set by the US Environmental Protection Agency as well as the Canadian standard CSA B415.1-10. For example, the Environmental Protection Agency, better known as EPA, limits emissions of certified wood heating appliances to no more than 4.5 grams per hour. In comparison, older conventional wood appliances average 40 grams per hour. Numerous countries, provinces and municipalities, have adopted laws that regulate the sale of wood-heating appliances that do not meet the latest standards in terms of particles emissions. Among them, we can name the United States, Australia, New Zealand, as well as numerous countries that are part of the European Union. In Canada, British Columbia, Quebec, Nova Scotia, New Brunswick and Newfoundland have also introduced laws regulating the sale of wood-heating appliances.

Wood, when burned in an appliance that has been tested to the EPA or CSA B415.1-10 standards, emits up to 80% less particles. It is a clean, renewable energy source. Furthermore, the reduction in fuelwood consumption reaches up to 30% when advanced wood combustion systems are used. This is because certified wood appliances are 60% to 80% efficient, compared with 40% to 60% for conventional units. As for appliances burning wood pellets, they have amongst the lowest particulate emissions of all solid-fuel burning appliances. They are manufactured from waste products and other renewable resources right here in North America. They represent a huge source of heating fuel from material that would otherwise be sent to landfills.

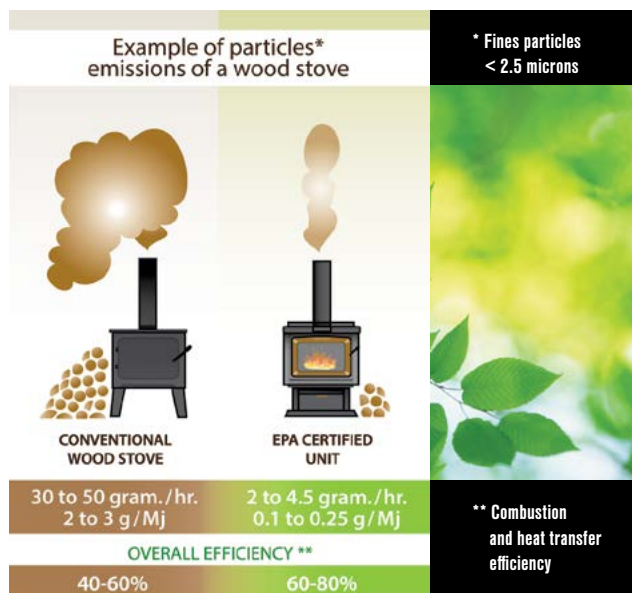



Maximum heat output,
dry cordwood

40,000 BTU/h

Recommended heating area

250 — 1,000 sq. ft. *

Fuel



Size

S



DUPLEX
Fireplace tool sets
See page 42

Osburn 900

Emissions
4.0 g/h

Optimum efficiency
78.2%

OB00900

900

BEYOND

SIZE

Osburn is proud to present its 900 model, the smallest wood stove in the Osburn range. The 900 still incorporates the features and the technology of the larger Osburn stoves. This EPA stove packs a lot of heat with style! With an output of up to 40,000 BTU/h, this sturdy heater will keep you warm and toasty. In spite of its size, the Osburn 900 takes an adequate log length of 17", making it an admired option in the small stove market.



Optional: firescreen.

Firebox volume:
1.3 cu. ft.

Maximum log length:
17".

Exterior dimensions:
25 3/4" H
22 7/8" W
21 7/8" D



Optional: premium quality
100 CFM blower with variable
speed control.

Optional: thermodisc kit.

Optional: quick connect
thermodisc.



Optional: fresh air intake kit.

Optional: flexible insulated
fresh air intake pipe
(4' length / 5" diameter).

*See the complete technical data on pages 13 and 14.



Maximum heat output,
dry cordwood

Recommended heating area

Fuel

Size

55,000 BTU/h

500 — 1,500 sq. ft.*



M



ABRIK
Fireplace tool sets
See page 42

SOHO

OB01520

Emissions
4.0 g/h

Optimum efficiency
75.3%

Soho with creme enameled decorative side panels and two-sided pedestal.

BEYOND
CONTEMPORARY
DESIGN

Once again, Osburn innovates to offer you the Soho, a small wood stove with an ultra modern design. This stove, which features an exceptional view of the fire, comes with an easy-to-operate door latch system that compliments the clean lines of the appliance. The Soho can be personalized according to your tastes and décor, thanks to its modular side panels available in different finishes and it offers two convenient and safe pedestal choices to store your logs. This stove can be equipped with an optional blower and thermodisc, in addition to being ready for a fresh air connection kit without the need for any special adaptor. The Soho is an ecological heating appliance that will please those seeking efficiency and contemporary design!



Required: black painted or creme or red enameled decorative side panels.

Firebox volume:
1.7 cu. ft.

Maximum log length:
17".



Required: regular pedestal with ash drawer.

Exterior dimensions:
32 7/8" H
25 3/4" W
20" D



Required: two-sided pedestal and ash drawer.

Exterior dimensions:
32 7/8" H
28 1/2" W
20" D



Optional: premium quality 130 CFM blower with variable speed control (thermodisc included).

Optional: quick connect thermodisc kit.

**Optional: flexible insulated fresh air intake pipe (4' length / 5" diameter).



Maximum heat output,
dry cordwood

Recommended heating area

Fuel

Size

65,000 BTU/h

500 – 1,800 sq. ft.*



M



FUSIO LOG HOLDER
Fireplace tool sets
See page 42

Osburn 1600 on pedestal with
brushed nickel plated door overlay.

Emissions
4.4 g/h

Optimum efficiency
80%

OB01613

1600

With its perfect balance between power, efficiency and cleanliness, the Osburn 1600 wood stove is truly unique. Able to heat up to 1,800 square feet with a performance of 65,000 BTU/h, it is also environmentally friendly with emissions that may go as low as 0.87 g/h, well below EPA standards. No compromise is necessary with the 1600 – you choose a pedestal or cast iron legs, then you select a black, golden fire brown, gold plated, or a brushed nickel plated door. Whatever your choice, you'll have a beautifully balanced wood stove.

BEYOND
COMBUSTION



Required: black or
brushed nickel plated cast iron
door overlay.

Firebox volume:
2.0 cu. ft.

Maximum log length:
17".



Required: black or brushed nickel
plated cast iron leg kit and ash pan.

Exterior dimensions on legs:
31 1/2" H
25" W
26 1/2" D



Required: pedestal with ash drawer
and safety lid.

Exterior dimensions on pedestal:
32 3/8" H
25" W
26 1/2" D



Optional: premium quality
130 CFM blower with variable
speed control.



**Optional: fresh air intake kit.
(pedestal version only)
**Optional: flexible insulated fresh
air intake pipe
(4' length / 5" diameter).

*See the complete technical data on pages 13 and 14.

**See note 2 on page 13.

Size

Fuel

Recommended heating area

Maximum heat output,
dry cordwood

L



500 — 2,100 sq. ft.*

75,000 BTU/h



INEO
Fireplace tool sets
See page 42



2000

OB02010

Emissions

3.9 g/h

Optimum efficiency

77.2%

Osburn 2000 with black door overlay.

BEYOND

CHARM

The Osburn 2000 is one of the most popular unit in the Osburn family of wood stoves. Its cast-iron door, which features the distinctive lines you've come to expect from Osburn, gives it a look combining the contemporary and the traditional. With a 2.4 cubic foot firebox, the Osburn 2000 will delight the most serious of wood stove enthusiasts who want both style and heating power. Also equipped with a 130 CFM blower, the Osburn 2000 is the most sought-after model of the season!



Required: black or brushed nickel plated cast iron door overlay.

Firebox volume:
2.4 cu. ft.

Maximum log length:
20".

Optional firescreen.



Required: black or brushed nickel plated cast iron leg kit with ash drawer and safety lid.

Exterior dimensions on legs:
32 3/8" H x 27" W x 30" D

Exterior dimensions on pedestal:
34 3/4" H x 27" W x 30" D



Required: pedestal with ash drawer and safety lid.

Optional: thermodisc kit.

Optional: quick connect thermodisc.



Premium quality 130 CFM blower with variable speed control included.



**Optional: fresh air intake kit.

**Optional: flexible insulated fresh air intake pipe (4' length / 5" diameter).



Maximum heat output,
dry cordwood

75,000 BTU/h

Recommended heating area

750 — 2,100 sq. ft.*

Fuel



Size

L



Glass hearth pad
54" X 46 3/4"
See page 42

ABRIK
Fireplace tool sets
See page 42

Matrix with soapstone panels.

Emissions
3.9 g/h

Optimum efficiency
77.2%

OB02020

MATRIX

BEYOND

CONTEMPORARY

The Matrix wood stove's clean and modern lines is sure to bring a European touch to any room. Inspired by the renowned finnish fireplaces, the top of the stove includes two rich pieces of soapstone. These canadian mined soapstones are also available as side panels kit that brings elegance to another level. Logs can be conveniently placed underneath the large firebox, making the Matrix not only stylish, but practical.



Required: soapstone or black painted panel kits.

Firebox volume:
2.4 cu. ft.

Maximum log length:
20".



Reversible door (hinged on left or right).

Ash pan with safety lid.

Exterior dimensions:
36 7/8" H
27 1/8" W
25 5/8" D



Premium quality 130 CFM blower with variable speed control included.

Quick connect thermdisc included.

**Fresh air intake adapter included.



Optional: firescreen.

**Optional: flexible insulated fresh air intake pipe (4' length / 5" diameter).

*See the complete technical data on pages 13 and 14.

**See note 2 on page 13.

Size

Fuel

Recommended heating area

Maximum heat output,
dry cordwood

L



800 — 2,000 sq. ft.*

70,000 BTU/h



SILHOUETTE
Fireplace tool sets
See page 42



2200

OB02211

Emissions
2.7 g/h

Optimum efficiency
75%

Osburn 2200 with brushed nickel plated door overlay and brushed nickel plated louver and trivet.

BEYOND

STYLE

Although similar in many ways to the 1800 model, the 2200 stove is suited for intensive, continuous use. Its 20% larger firebox is designed to maintain steady heat over a longer period. A powerful, premium quality 130 CFM blower is available as an option. The glass surface of the bay window is also 20% larger than that of the 1800 model, providing a wonderful view of the fire from every angle. In short, the Osburn 2200 offers a perfect combination of utility and enjoyment!



Required: black or brushed nickel plated door overlay.

Required: black or brushed nickel plated louver and trivet.

Firebox volume:
2.3 cu. ft.

Maximum log length:
18".



Ash drawer with safety lid.

Exterior dimensions:
32 1/8" H
26" W
26 1/4" D



Optional: premium quality 130 CFM blower with variable speed control.



**Optional: fresh air intake kit.

**Optional: flexible insulated fresh air intake pipe (4' length / 5" diameter).



Maximum heat output,
dry cordwood

Recommended heating area

Fuel

Size

90,000 BTU/h

900 – 2,300 sq. ft. *



XL



PAPYRUS
Fireplace tool sets
See page 42

Osburn 2300 with brushed nickel plated cast iron door overlay and legs.

Emissions
4.5 g/h

Optimum efficiency
75%

OB02302

2300

BEYOND

PERFORMANCE

The Osburn 2300 is designed for intensive use. The depth of its firebox and the large door opening makes wood loading easy, with logs up to 20 inches. Its hidden hinges and very large glass surface embellish its use. Each 2300 model is equipped with an premium quality blower. The secondary air pipes and C-Cast baffle ensure combustion of the highest quality.



Required: black or brushed nickel plated cast iron door overlay.

Firebox volume:
3.4 cu. ft.

Maximum log length:
20".



Required: black or brushed nickel plated cast iron leg kit with ash pan.

Exterior dimensions:
On legs On pedestal
33" H 33 5/8" H
25 3/4" W 25 3/4" W
34 7/8" D 34 7/8" D



Required: pedestal with ash drawer and safety lid.

Optional: thermodisc kit.

Optional: quick connect thermodisc.



Premium quality 100 CFM blower with variable speed control included.



**Optional: fresh air intake kit.
**Optional: flexible insulated fresh air intake pipe (4' length / 5" diameter).

*See the complete technical data on pages 13 and 14.

**See note 2 on page 13.

Size	Fuel	Recommended heating area	Maximum heat output, dry cordwood	 **	
XL		1,000 – 2,700 sq. ft.*	100,000 BTU/h		



2400

OB02411

Emissions
3.9 g/h

Optimum efficiency
78%

Osburn 2400 with brushed nickel plated door overlay.

BEYOND

HEAT

Some of the Osburn 2400's impressive features include a 3.4 cubic foot firebox; a Recommended heating area that's up to 2,700 square feet; it takes logs up to 21"; and burns up to 10 hours in low combustion mode*. In addition to its impressive performance, the 2400 is environmentally efficient, with emissions as low as 1.6 g/h (in medium-high combustion mode). If you're looking for a large wood stove for your home or cottage, the Osburn 2400 is a perfect choice.



Required: black or brushed nickel plated cast iron door overlay.

Firebox volume:
3.4 cu. ft.

Maximum log length:
21".



Pedestal and ash drawer with safety lid.

Exterior dimensions:
33" H
30" W
30 5/8" D



Optional: premium quality 130 CFM blower with variable speed control.



**Optional: fresh air intake kit.

**Optional: flexible insulated fresh air intake pipe (4' length / 5" diameter).

Technical data: Wood stoves

GENERAL FEATURES: WOOD STOVES



MODELS	900	Soho	1600	2000
Color	Metallic Black	Metallic Black	Metallic Black	Metallic Black
Maximum burn time (note 1)	5 hours	6 hours	6 hours	8 hours
Combustion technology	Non-catalytic	Non-catalytic	Non-catalytic	Non-catalytic
Recommended heating area (note 1)	250 to 1,000 sq. ft	500 to 1,500 sq. ft	500 to 1,800 sq. ft	500 to 2,100 sq. ft
Maximum heat output - dry cordwood	40,000 BTU/h (11.7 kW)	55,000 BTU/h (16.1 kW)	65,000 BTU/h (19.0 kW)	75,000 BTU/h (22.0 kW)
Overall heat output rate (min. to max.)	10,800 BTU/h (3.2 kW) to 22,600 BTU/h (6.6 kW)	11,400 BTU/h (3.3 kW) to 25,400 BTU/h (7.4 kW)	11,800 BTU/h (3.5 kW) to 42,400 BTU/h (12.4 kW)	12,500 BTU/h (3.7 kW) to 31,300 BTU/h (9.2 kW)
Door opening size (W x H)	15" x 7 5/8"	15 3/4" x 7 1/4"	15 5/8" x 8 3/8"	17 1/2" x 9"
Firebox dimensions (W x H x D)	18 3/8" x 9 5/8" x 12 1/2"	18 1/8" x 12 1/4" x 13 1/2"	18 1/8" x 12 7/8" x 14 3/4"	21" x 11 7/8" x 16 3/4"
Firebox volume	1.3 cu. ft.	1.7 cu. ft.	2.0 cu. ft.	2.4 cu. ft.
Average particulate emissions rate	4.0 g/h	4.0 g/h	4.4 g/h	3.9 g/h
Glass viewing area (W x H)	13 3/8" x 7 3/4"	16 1/4" x 8 1/4"	15" x 8 3/8"	17 1/4" x 9 1/2"
Door frame	Cast iron with logo	Steel	Cast iron with logo	Cast iron with logo
Maximum log length	17"	17"	17"	20"
Optimum efficiency	78.2%	75.3%	80%	77.2%
Mobile home approved (note 2)	No	Yes	Yes	Yes
Approved for an alcove installation	Yes	No	No	No
Flue spigot diameter	6"	6"	6"	6"
Glass type	Ceramic glass			
Adjustable handle	Yes			
Self-cleaning glass system	Yes			
Ash drawer with safety lid	Yes (all freestanding wood stoves) except Osburn 900			
Warranty	Lifetime, limited			
Test standard - Safety	According to ULC S627, UL 1482, UL 737, NFPA 211 and CSA B365 standards applicable in Canada and USA			
Test standard - Emissions / efficiency	EPA / CSA B415.1-10			

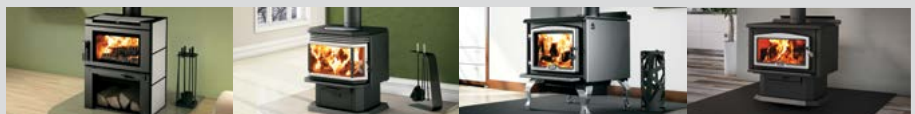

MODELS	Matrix	2200	2300	2400
Color	Metallic Black	Metallic Black	Metallic Black	Metallic Black
Maximum burn time (note 1)	8 hours	8 hours	10 hours	10 hours
Combustion technology	Non-catalytic	Non-catalytic	Non-catalytic	Non-catalytic
Recommended heating area (note 1)	750 to 2,100 sq. ft	800 to 2,000 sq. ft	900 to 2,300 sq. ft	1,000 to 2,700 sq. ft
Maximum heat output - dry cordwood	75,000 BTU/h (22.0 kW)	70,000 BTU/h (20.5 kW)	90,000 BTU/h (26.4 kW)	100,000 BTU/h (29.3 kW)
Overall heat output rate (min. to max.)	12,500 BTU/h (3.7 kW) to 31,300 BTU/h (9.2 kW)	11,700 BTU/h (3.4 kW) to 30,400 BTU/h (8.9 kW)	11,700 BTU/h (3.4 kW) to 26,400 BTU (7.7 kW)	13,300 BTU (3.9 kW) to 44,100 BTU/h (12.9 kW)
Door opening size (W x H)	17 1/2" x 8 3/4"	19 1/8" x 8 7/8"	15 1/2" x 11 1/2"	19 1/2" x 8"
Firebox dimensions (W x H x D)	21" x 12" x 16 1/2"	19 1/8" x 12 1/4" x 17 1/4"	18 3/8" x 14 7/8" x 21 1/4"	22 1/2" x 13 1/2" x 19 3/8"
Firebox volume	2.4 cu. ft.	2.3 cu. ft.	3.4 cu. ft.	3.4 cu. ft.
Average particulate emissions rate	3.9 g/h	2.7 g/h	4.5 g/h	3.9 g/h
Glass viewing area (W x H)	19 5/8" x 11 7/8"	26 1/4" x 10 3/8"	15 1/8" x 10 7/8"	19 1/8" x 8 7/8"
Door frame	Cast iron, reversible	Steel	Cast iron with logo	Cast iron with logo
Maximum log length	20"	18"	20"	21"
Optimum efficiency	77.2%	75%	75%	78%
Mobile home approved (note 2)	Yes	Yes	Yes	Yes
Approved for an alcove installation	No	No	No	No
Flue spigot diameter	6"	6"	6"	6"
Glass type	Ceramic glass			
Adjustable handle	Yes			
Self-cleaning glass system	Yes			
Ash drawer with safety lid	Yes (all freestanding wood stoves) except Osburn 900			
Warranty	Lifetime, limited			
Test standard - Safety	According to ULC S627, UL 1482, UL 737, NFPA 211 and CSA B365 standards applicable in Canada and USA			
Test standard - Emissions / efficiency	EPA / CSA B415.1-10			

Note 1: Recommended heating area and maximum burn time may vary subject to location in home, chimney draft, heat loss factors, climate, fuel type and other variables. The recommended heated area for a given appliance is defined by the manufacturer as its capacity to maintain a minimum acceptable temperature in the designated area in case of a power failure.

Note 2: With fresh air intake kit.

SPECIFIC FEATURES: WOOD STOVES

MODELS	900	Soho	1600	2000	Matrix	2300	2400
Exterior dimensions and weight							
Height (pedestal)	N/A	32 7/8"	32 3/8"	34 3/4"	36 7/8"	33 5/8"	33"
Height (legs)	25 3/4"	N/A	31 1/2"	32 3/8"	N/A	33"	N/A
Width (pedestal/two-sided pedestal)	N/A	25 3/4" / 28 1/2"	25"	27"	27 1/8"	26"	30"
Width (legs)	22 7/8"	N/A	25"	27"	N/A	25 3/4"	N/A
Depth (pedestal)	N/A	20"	26 1/2"	30"	25 5/8"	26 1/4"	30 5/8"
Depth (legs)	21 7/8"	N/A	26 1/2"	30"	N/A	34 7/8"	N/A
Weight	273 lb (124 kg)	326 lb (148 kg)	360 lb (163 kg)	390 lb (177 kg)	537 lb (244 kg)	450 lb (204 kg)	513 lb (233 kg)
Clearances from unit to combustible materials (figures 1, 2, and 3)							
With single wall pipe (note 3)							
A— Sides (Canada / USA)	18"	16"	16"	17"	16"	12"	17" / 18"
B— Back (Canada / USA)	15 1/4" / 15"	15"	15"	15"	15"	15" / 12"	14" / 16"
C— Corner (Canada / USA)	10"	8 1/2" / 8"	12"	10"	10"	10"	8" / 12"
With double wall pipe							
A— Sides (Canada / USA)	18"	16"	16" / 20"	17"	14"	12"	15" / 17"
B— Back (Canada / USA)	10"	12"	6"	6"	6"	5"	7" / 12"
C— Corner (Canada / USA)	10"	6"	6"	5"	6"	3"	7"
D— Ceiling (Canada / USA) - (note 4)	68"	84"	84"	84"	72"	84"	84"

Blower	Optional	Optional	Optional	Included	Included	Optional	Included	Optional
Black door overlay	Included	Included	Optional	Optional	Included	Optional	Optional	Optional
Brushed nickel plated door overlay	N/A	N/A	Optional	Optional	N/A	Optional	Optional	Optional
Pedestal	N/A	Optional	Optional	Optional	Included	Included	Optional	Included
Black cast iron legs	Included	N/A	Optional	Optional	N/A	N/A	Optional	N/A
Brushed nickel plated cast iron legs	N/A	N/A	Optional	Optional	N/A	N/A	Optional	N/A
Black louver and trivet	N/A	N/A	N/A	N/A	N/A	N/A	N/A	N/A
Brushed nickel plated louver and trivet	N/A	N/A	N/A	N/A	N/A	Optional	N/A	N/A
Soapstone panel kit	N/A	N/A	N/A	N/A	Optional	N/A	N/A	N/A
Black decorative side panels	N/A	Optional	N/A	N/A	Optional	N/A	N/A	N/A
Red enameled decorative side panels	N/A	Optional	N/A	N/A	N/A	N/A	N/A	N/A
Creame enameled decorative side panels	N/A	Optional	N/A	N/A	N/A	N/A	N/A	N/A

Note 3: Consult local code for minimum clearances of the single wall pipe itself to combustible materials. See also the venting manufacturer's instructions.
 Note 4: Measured from the base of the appliance. Some appliances have been tested with a low ceiling. Before setting up your unit, refer to the installation manual.

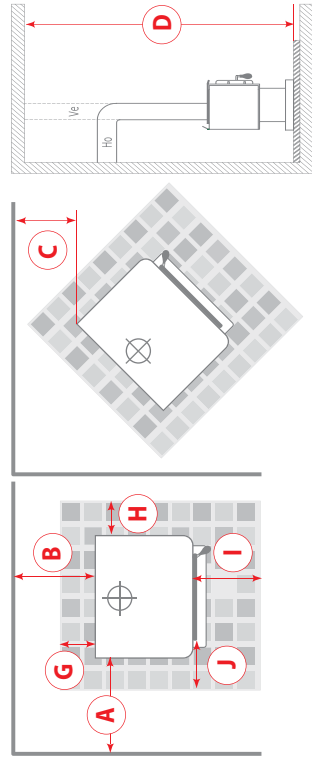

Figure 1 **Figure 2** **Figure 3**

FLOOR PROTECTOR*		
	CANADA	USA
G	8" – Note **	N/A (Canada only)
H	8"	N/A (Canada only)
I	18" From door opening	16" From door opening
J	N/A (USA only)	8" From door opening

*Steel with a minimum thickness of 0.015" (0.38 mm) or ceramic tiles sealed together with grout. No protection is required if the unit is installed on a non-combustible floor (ex: concrete).

**The floor protection at the back of the stove is limited to the stove's required clearance if such clearance is smaller than 8 inches (203 mm).
 Technical data contained in this brochure are for reference only. Any installation must be done according to the data and drawings detailed in the owner's manual.



Maximum heat output,
dry cordwood

50,000 BTU/h

Recommended heating area

250 — 1,400 sq. ft.*

Fuel



Size

S



Osburn 1100 insert with brushed nickel plated door overlay and black faceplate and trims.

Emissions

2.9 g/h

Optimum efficiency

75%

OB01151

1100
Insert

The 1100 insert is the ready-made solution for smaller masonry fireplaces. With its flue at a 45° angle, it offers a wide range of configurations. The floor of its firebox is 2.5 inches deep, allowing greater accumulation of ashes and cleaner use. The 1100 insert also comes with a powerful 144 CFM blower. You'll be amazed and delighted by the 50,000 BTU/h of heat it provides!

BEYOND

FLEXIBILITY



Required: black or brushed nickel plated cast iron door overlay.

Firebox volume:
1.5 cu. ft.

Maximum log length:
17".



Premium quality 144 CFM heat activated blower with variable speed control included.

Exterior dimensions:
21 1/8" H
25 1/2" W
22 1/4" D



Required: black faceplate kit. Regular (29" X 44").



Optional: black or brushed nickel faceplate trims. Regular (29" X 44").

*See the complete technical data on pages 22 and 23.

Size	Fuel	Recommended heating area	Maximum heat output, dry cordwood	
M		500 — 1,800 sq. ft.*	65,000 BTU/h	



1600
Insert

OB01601

Emissions
4.4 g/h

Optimum efficiency
80%

Osburn 1600 insert with brushed nickel plated door overlay and black faceplate trims.

BEYOND
COMBUSTION

With its compact design, the 1600 insert can be installed in a fireplace as small as 14 3/8" deep. Yet it offers a performance of up to 65,000 BTU/h and burns 17" logs. The standard 130 CFM blower helps maximize the stove's energy performance. The very low emissions at normal operating temperatures, positions the 1600 insert as an excellent choice for those seeking an environmentally friendly and ultra-efficient source of heat.



Required: black or brushed nickel plated cast iron door overlay.

Firebox volume:
2.0 cu. ft.

Maximum log length:
17".



Premium quality 130 CFM heat activated blower with variable speed control included.

Exterior dimensions:
22 5/8" H
25 7/8" W
26" D

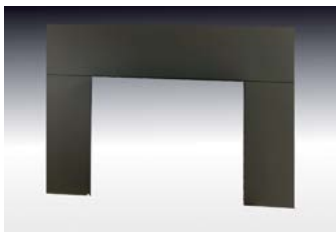

Required: black faceplate kits. Regular (29" X 44"), Medium (32" X 44") or Large (32" X 50").



Optional: black or brushed nickel faceplate trims. Regular (29" X 44"), Medium (32" X 44") or Large (32" X 50").

*See the complete technical data on pages 22 and 23.



Maximum heat output,
dry cordwood

65,000 BTU/h

Recommended heating area

500 – 1,800 sq. ft.*

Fuel



Size

M



Osburn 1800 insert with black door overlay and trims with black faceplate kit.

Emissions
2.8 g/h

Optimum efficiency
75%

OB01801

1800
Insert

Like its cousins in the 1800/2200 freestanding series, the 1800 insert offers the same tried-and tested design and the same great features, including a magnificent view of the fire through the bay window. It is also equipped with a powerful blower, transforming your old, inefficient fireplace into a highly effective heating system. The 1800 insert is both practical and elegant. It is a perfect choice to upgrade your living room or basement fireplace.

BEYOND
CHARACTER



Required: black or brushed nickel plated cast iron door overlay.

Firebox volume:
1.8 cu. ft.

Maximum log length:
16".



Premium quality 90 CFM heat activated blower with variable speed control included.

Exterior dimensions:
20 3/8" H
30" W
25 3/8" D



Required: black faceplate kits. Regular (29" X 44") or Medium (32" X 44").

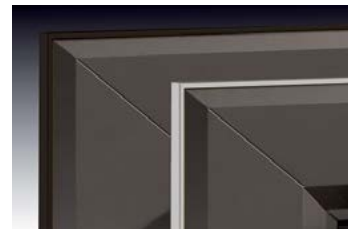

Optional: black or brushed nickel faceplate trims. Regular (29" X 44") or Medium (32" X 44").

*See the complete technical data on pages 22 and 23.

Size	Fuel	Recommended heating area	Maximum heat output, dry cordwood	
L		500 — 2,100 sq. ft. *	75,000 BTU/h	



TORSADE
Fireplace tool sets
See page 42

2000
Insert

OB02011	Emissions 3.9 g/h	Optimum efficiency 77.2%	Osburn 2000 insert with brushed nickel plated door overlay and trims and black faceplate kit.
---------	----------------------	-----------------------------	---

BEYOND
CHARM

With its 2.4 cubic foot firebox, the Osburn 2000 insert offers an alternative to the people who love its freestanding counterpart. The two models share the same high quality combustion properties and many of the same features. The Osburn 2000 comes with a standard high-power, heat-activated 144 CFM blower strategically positioned to redistribute the heat from the firebox into the room. The 2000 model is designed to receive an optional faceplate that can cover a masonry hearth up to 32 inches (81 cm) high and 50 inches (127 cm) wide. The door overlay is available in black or brushed nickel plated finishes. The faceplate trims are available in black or brushed nickel.



Required: black or brushed nickel plated cast iron door overlay.

Firebox volume:
2.4 cu. ft.

Maximum log length:
20".



Premium quality 144 CFM heat activated blower with variable speed control included.

Exterior dimensions:
23 1/8" H
28 3/8" W
26 1/2" D



Required: black faceplate kits. Regular (29" X 44") or Large (32" X 50").



Optional: firescreen.

Optional: fresh air intake kit.



Optional: black or brushed nickel faceplate trims. Regular (29" X 44") or Large (32" X 50").



Optional: heat shield mantle shelf and combustible top surround.

*See the complete technical data on pages 22 and 23.



Maximum heat output,
dry cordwood

Recommended heating area

Fuel

Size

75,000 BTU/h

750 – 2,100 sq. ft.*



L



SILHOUETTE
Fireplace tool sets
See page 42

Matrix insert with cast iron
faceplate.

Emissions
3.9 g/h

Optimum efficiency
77.2%

OB02021

MATRIX
Insert

The Matrix wood insert defines the new standards for contemporary look and performance. This appliance looks like a fireplace, but has all the advantages of an insert. Its faceplate and blower assembly were developed to allow a flush finish with the masonry fireplace. Cast iron was selected as the material of choice for this clean and modern unit. Installation into larger openings is facilitated by the use of an optional sheet metal backing plate. This insert will surely become the focal point of the room.

BEYOND
CONTEMPORARY



Reversible cast iron door
(hinged on left or right).

Firebox volume:
2.4 cu. ft.

Maximum log length:
20".

Cast iron faceplate (included):
25 1/4" H x 36 1/8" W



Optional: firescreen.

Exterior dimensions:

With faceplate (included):
25 1/8" H
36 1/8" W
23 1/8" D

Without faceplate:
23 3/8" H
28 3/8" W
23 1/8" D



Optional: faceplate backing plate
panels (29" x 44" / 29" x 50").



Optional: bottom faceplate
backing plate panels (44" x 6" /
50" x 6").

Optional: fresh air intake kit.



Projection kit for insert 2" or 4".
*Requires the optional faceplate
backing plate for installation.*



Premium quality 90 CFM
heat activated blower included.

*See the complete technical data on pages 22 and 23.

Size	Fuel	Recommended heating area	Maximum heat output, dry cordwood	
L		800 – 2,000 sq. ft.*	70,000 BTU/h	



INEO
Fireplace tool sets
 See page 42

2200 Insert	OB02201	Emissions	Optimum efficiency	Osburn 2200 with black cast iron door overlay, faceplate kit and trims.
		2.7 g/h	75%	

BEYOND
 STYLE

The 2200 insert, with its focus on efficiency and elegance, is an excellent example of Osburn’s know-how. The bay window adds a touch of style to your fireplace and also improves its heat output. The 2200 insert is designed to offer a long Maximum burn time in low combustion mode, and can provide comfort for many hours – even overnight* – thanks among other things to its premium quality blower. The Osburn 2200 insert offers superior features in an eye-catching, high performance wood insert.



Required: black or brushed nickel plated cast iron door overlay.

Firebox volume:
 2.3 cu. ft.

Maximum log length:
 18".

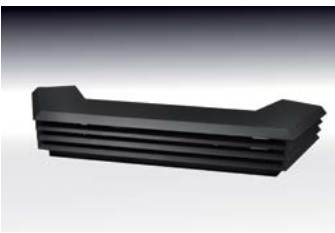

Premium quality 130 CFM heat activated blower with variable speed control included.

Exterior dimensions:
 23 1/8" H
 32 7/8" W
 28 3/8" D



Required: black faceplate kits. Regular (29" X 44"), Medium (32" X 44") or Large (32" X 50").

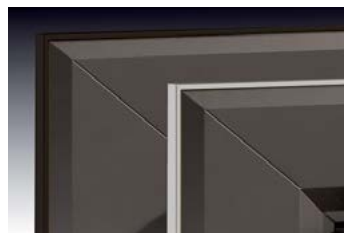

Optional: black or brushed nickel faceplate trims. Regular (29" X 44"), Medium (32" X 44") or Large (32" X 50").

*See the complete technical data on pages 22 and 23.



Maximum heat output,
dry cordwood

100,000 BTU/h

Recommended heating area

1,000 — 2,700 sq. ft.*

Fuel



Size

XL



Osburn 2400 insert with brushed nickel plated door overlay and trims and black faceplate kit.

Emissions
3.9 g/h

Optimum efficiency
78%

OB02401

2400
Insert

The 2400 insert has the same firebox as its freestanding counterpart and will transform any conventional masonry fireplace into a highly efficient heating system. Its 100,000 BTU/h, combined with a 3.4 cubic foot firebox, will help you to rest easy during those long winter nights. Its large glass window offers a perfect view of the fire.

BEYOND
HEAT



Required: black or brushed nickel plated cast iron door overlay.

Firebox volume:
3.4 cu. ft.

Maximum log length:
21".



Premium quality 144 CFM heat activated blower with variable speed control included.

Exterior dimensions:
23" H
31 1/8" W
28" D



Required: black faceplate kits. Regular (29" X 44"), Medium (32" X 44") or Large (32" X 50").



Optional: black or brushed nickel faceplate trims. Regular (29" X 44"), Medium (32" X 44") or Large (32" X 50").

*See the complete technical data on pages 22 and 23.

Technical data: Wood inserts

GENERAL FEATURES: WOOD INSERTS



MODELS	1100 Insert	1600 Insert	1800 Insert
Color	Metallic Black	Metallic Black	Metallic Black
Maximum burn time (Note 1)	6 hours	6 hours	6 hours
Combustion technology	Non-catalytic	Non-catalytic	Non-catalytic
Recommended heating area (Note 1)	250 to 1,400 sq. ft	500 to 1,800 sq. ft	500 to 1,800 sq. ft
Maximum heat output - dry cordwood	50,000 BTU/h (14.6 kW)	65,000 BTU/h (19.0 kW)	65,000 BTU/h (19.0 kW)
Overall heat output rate (min. to max.)	11,000 BTU/h (3.2 kW) to 35,000 BTU/h (10.2 kW)	11,800 BTU/h (3.5 kW) to 42,400 BTU/h (12.4 kW)	9,700 BTU/h (2.8 kW) to 36,300 BTU/h (10.6 kW)
Door opening size (W x H)	15 5/8" x 8 3/8"	15 5/8" x 8 1/2"	18 3/8" x 8 1/2"
Firebox dimensions (W x H x D)	18 1/8" x 11 1/2" x 12 5/8"	18 1/8" x 12 7/8" x 14 3/4"	16 7/8" x 11 1/2" x 14 5/8"
Firebox volume	1.5 cu. ft.	2.0 cu. ft.	1.8 cu. ft.
Average particulate emissions rate	2.9 g/h	4.4 g/h	2.8 g/h
Glass viewing area (W x H)	15" x 8 3/8"	15" x 8 3/8"	22 3/4" x 9 3/8"
Door frame	Cast iron with logo	Cast iron with logo	Steel
Maximum log length	17"	17"	16"
Optimum efficiency	75%	80%	75%
Flue spigot diameter	6"	6"	6"
Glass type	Ceramic glass		
Adjustable handle	Yes		
Self-cleaning glass system	Yes		
Warranty	Lifetime, limited		
Test standard - Safety	According to UL 1482, UL 737, ULC S628, NFPA 211 and CSA B365 applicable in Canada and the United States		
Test standard - Emissions / efficiency	EPA / CSA B415.1-10		



MODELS	2000 Insert	Matrix Insert	2200 Insert	2400 Insert
Color	Metallic Black	Metallic Black	Metallic Black	Metallic Black
Maximum burn time (Note 1)	8 hours	8 hours	8 hours	10 hours
Combustion technology	Non-catalytic	Non-catalytic	Non-catalytic	Non-catalytic
Recommended heating area (Note 1)	500 to 2,100 sq. ft	750 to 2,100 sq. ft	800 to 2,000 sq. ft	1,000 to 2,700 sq. ft
Maximum heat output - dry cordwood	75,000 BTU/h (22.0 kW)	75,000 BTU/h (22.0 kW)	70,000 BTU/h (20.5 kW)	100,000 BTU/h (29.3 kW)
Overall heat output rate (min. to max.)	12,500 BTU/h (3.7 kW) to 31,300 BTU/h (9.2 kW)	12,500 BTU/h (3.7 kW) to 31,300 BTU/h (9.2 kW)	11,700 BTU/h (3.4 kW) to 30,400 BTU/h (8.9 kW)	13,300 BTU/h (3.9 kW) to 44,100 BTU/h (12.9 kW)
Door opening size (W x H)	17 1/2" x 9"	17 1/2" x 8 3/4"	19 1/8" x 9"	19 1/2" x 8"
Firebox dimensions (W x H x D)	21" x 11 7/8" x 16 3/4"	21" x 11 7/8" x 16 1/2"	19 1/8" x 12 1/4" x 17 1/4"	22 1/2" x 13 1/2" x 19 3/8"
Firebox volume	2.4 cu. ft.	2.4 cu. ft.	2.3 cu. ft.	3.4 cu. ft.
Average particulate emissions rate	3.9 g/h	3.9 g/h	2.7 g/h	3.9 g/h
Glass viewing area (W x H)	17 1/4" x 9 1/2"	19 5/8" x 11 7/8"	26 1/4" x 10 3/8"	19 1/8" x 8 7/8"
Door frame	Cast iron with logo	Cast Iron	Steel	Cast iron with logo
Maximum log length	20"	20"	18"	21"
Optimum efficiency	77.2%	77.2%	75%	78%
Flue spigot diameter	6"	6"	6"	6"
Glass type	Ceramic glass			
Adjustable handle	Yes			
Self-cleaning glass system	Yes			
Warranty	Lifetime, limited			
Test standard - Safety	According to UL 1482, UL 737, ULC S628, NFPA 211 and CSA B365 applicable in Canada and the United States			
Test standard - Emissions / efficiency	EPA / CSA B415.1-10			

Note 1: Recommended heating area and maximum burn time may vary subject to location in home, chimney draft, heat loss factors, climate, fuel type and other variables. The recommended heated area for a given appliance is defined by the manufacturer as its capacity to maintain a minimum acceptable temperature in the designated area in case of a power failure.

SPECIFIC FEATURES: WOOD INSERTS

MODELS	1100 Insert	1600 Insert	1800 Insert	2000 Insert	Matrix Insert	2200 Insert	2400 Insert
Exterior dimensions and weight							
Height	21 1/8"	22 5/8"	20 3/8"	23 1/8"	25 1/8"	23 1/8"	23"
Width	25 1/2"	25 7/8"	30"	28 3/8"	36 1/8"	32 7/8"	31 1/8"
Depth	22 1/4"	26"	25 3/8"	26 1/2"	23 1/8"	28 3/8"	28"
Weight	297 lb (135 kg)	378 lb (172 kg)	307 lb (139 kg)	421 lb (191 kg)	484 lb (220 kg)	380 lb (172 kg)	512 lb (232 kg)
Clearances from unit to combustible materials (see figure 1)							
A- Adjacent sidewall	13"	16"	17"	16"	16"	17"	14"
B- Combustible side surround	9"	10"	10"	12"	12"	10"	8"
C- Combustible top surround	27"	16"	14"	20"	20"	14"	20 1/2"
Reduced clearance with heat shield for combustible top surround	N/A	N/A	N/A	11"	N/A	N/A	N/A
D- Combustible mantle shelf dimension	6" 8" 10" 12"	9 1/2" 22"	6" 8" 10" 12"	8" 10" 12"	8" 10" 12"	6" 9 1/2" 10" 12"	6" 8" 10" 12"
E- Minimum clearance from a combustible mantle shelf	27" 29" 31" 33"	22"	22" 24" 26" 28"	22" 24" 26"	18 5/8" 20 5/8" 22 5/8"	22" 22 1/2" 22 1/2"	25 1/2" 27 1/2" 29 1/2" 31 1/2"
F, G, H- Minimum fireplace opening (Height x Width x Depth)	21 3/4" x 26" x 12 7/8"	22 5/8" x 26 3/8" x 14 3/8"	20" x 23 3/8" x 14 5/8"	23 3/8" x 28 7/8" x 15 3/4"	23 3/8" x 28 7/8" x 19 5/8"	22 5/8" x 26 1/4" x 17 3/8"	23 1/2" x 31 5/8" x 16 1/4"
I- Minimum floor protection in front of unit (CAN / USA)	18" / 16"	18" / 16"	18" / 16"	18" / 16"	18" / 16"	22" **	18" / 16"
Faceplate dimensions							
Regular in cast iron (included)	N/A	N/A	N/A	N/A	25 1/4" x 36 1/8"	N/A	N/A
Regular in steel	29" x 44"	29" x 44"	29" x 44"	29" x 44"	N/A	29" x 44"	29" x 44"
Medium in steel	N/A	32" x 44"	32" x 44"	N/A	N/A	32" x 44"	32" x 44"
Large in steel	N/A	32" x 50"	N/A	32" x 50"	N/A	32" x 50"	32" x 50"
Faceplate trim kit	Black or brushed nickel	Black or brushed nickel	Black or brushed nickel	Black or brushed nickel	N/A	Black or brushed nickel	Black or brushed nickel
Faceplate backing plate panels	N/A	N/A	N/A	N/A	29" x 44" / 29" x 50"	N/A	N/A
Bottom faceplate backing plate panels	N/A	N/A	N/A	N/A	44" x 6" / 50" x 6"	N/A	N/A
Projection kit	N/A	N/A	N/A	N/A	2" or 4"	N/A	N/A
Blower	Included	Included	Included	Included	Included	Included	Included
Black door overlay	Optional	Optional	Optional	Optional	Included	Optional	Optional
Brushed nickel plated door overlay	Optional	Optional	Optional	Optional	N/A	Optional	Optional

* The depth of the fireplace opening of the Matrix Insert can be reduce to 17 5/8" or 15 5/8" using the optional projection kit ACO1323, sold separately. Note however that in order to install the optional projection kit ACO1323, one of the optional faceplate backing plate kit ACO1322 or ACO1332 must be purchased separately to secure the projection kit to it.

**This model in particular must have 16" in front of the blower housing. This distance is included in the "I" measurement of the above table.

Technical data & sizes contained in this brochure are for reference only. Any installation must be done according to the data and drawings detailed in the owner's manual.

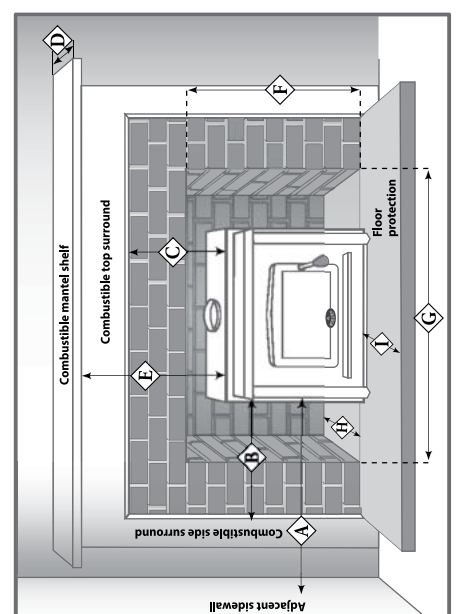

Figure 1

From door opening

Size	Fuel	Recommended heating area	Maximum heat output, dry cordwood	
L		750 — 2,100 sq. ft. *	75,000 BTU/h	



EQUISS LOG HOLDER
Fireplace tool sets
See page 42

STRATFORD	OB04002	Emissions 4.4 g/h	Optimum efficiency 75%	Stratford with brushed nickel plated cast iron door overlay and traditional faceplate with brushed nickel accents.
------------------	---------	----------------------	---------------------------	--

BEYOND
DESIGN

Here's what you've been hoping to find, a decorative and efficient wood fireplace that meets EPA emissions standards. That's saying a lot, but the Osburn Stratford has much more to offer, including a 2.5 cubic foot firebox that's easy to access through double-cast iron doors. The Osburn Stratford will impress you with its distinctive style and exceptional Recommended heating area. Several options are available, including a air distribution systems for heating adjacent rooms (see page 30). With the Osburn Stratford, there's a world of possibilities waiting for you!



Required: black or brushed nickel plated cast iron door overlay.

Optional faceplate: Prairie style, traditional or traditional with brushed nickel accents.

Firebox volume:
2.5 cu. ft.



Optional: firescreen.

Exterior dimensions:
47 1/8" H
37 7/8" W
29 5/8" D

Maximum log length:
21".



Optional: forced air distribution kit controlled by wall thermostat (see page 30).

Optional: 6" x 25' insulated flex pipe for forced air distribution kit.

Optional: hot air gravity distribution kit traditional style or modern with adjustable pipes. (see page 30).



Twin premium quality heat activated 176 CFM blowers included.

Fresh air intake kit adapter 3" or 4" diameter included.

Optional: 3" flexible insulated fresh air intake pipe (10 feet).

*See the complete technical data on page 27.



Maximum heat output,
dry cordwood

80,000 BTU/h

Recommended heating area

750 — 2,200 sq. ft.*

Fuel



Size

L

SILHOUETTE
Fireplace tool sets
See page 42

**Montreal
APPROVED**
< 2.5 g/h

ONLY AVAILABLE IN CANADA

Everest, wood fireplace with faceplate
and retractable doors.

Emissions
2.3 g/h

Optimum efficiency
73.9 %

OB04015

EVEREST

BEYOND

HEAT

Beyond Fire! Give life to your living space with this wood-burning fireplace; its sleek modern lines blend with any decor.

Heat. Make every evening a perfect one by remaining warm by the hearth. This fireplace heats an area of up to 2,200 square feet.

Simplicity. The Everest easily integrates into the look of your room. Its façade has retractable double doors and is available in either a black or brushed nickel finish.

Reliability. This high-quality fireplace is carefully manufactured in Quebec.

Enjoy the benefits of its reassuring presence during the long cold winter months.



Required: black or brushed nickel
plated cast iron door overlay.

Firebox volume:
3.1 cu. ft.

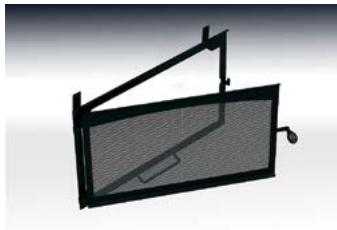

Optional: firescreen.

Exterior dimensions:
40 5/8" H
37 1/8" W
29 1/4" D

Maximum log length:
16".



Optional: forced air distribution
kit controlled by wall thermostat
(see page 30).

Optional: 6" x 25' insulated flex
pipe for forced air distribution kit.

Optional: hot air gravity
distribution kit traditional style
(see page 30).



Twin premium quality heat activated
144 CFM blowers included.

Fresh air intake kit adapter 4"
diameter included.

Optional: 4" flexible insulated fresh
air intake pipe (10 feet).

*See the complete technical data on page 27.

Size	Fuel	Recommended heating area	Maximum heat output, dry cordwood	
XL		1,000 — 2,800 sq. ft. *	95,000 BTU/h	

Montreal APPROVED
<2.5 g/h

A hot start is always your best guarantee for a clean burn. The Horizon uses an automated combustion air intake system that allows the fire to reach an ideal temperature before going into slow burn mode. The result is very low emissions, without the need for a catalytic combustor.



HORIZON

OB04010	Emissions 1.6 g/h	Optimum efficiency 69.7 %	Horizon, extra-large wood-burning fireplace. Installation requires an 8" chimney.
---------	----------------------	------------------------------	---

BEYOND

This wood fireplace offers peace of mind due to the combination of energy efficiency and clean heating. A simple solution; its clean design suits any type of décor.

SIZE

Large fireplace. Behind its large glass door, the 4.28 cubic foot combustion chamber can hold an impressive 60 lb of wood.
Low emissions. This energy efficient fireplace complies with the EPA's clean-air standards (only 1.6 g/h of emissions).
High efficiency. The Horizon fireplace is capable of heating large spaces and burns for 10 hours.



Required: Prairie-style faceplate.
 Firebox volume:
 4.28 cu. ft.

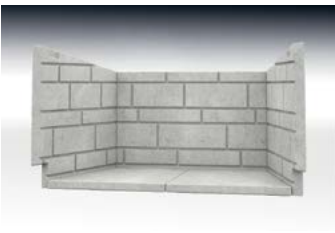

Required: Classic moulded refractory brick panels.
 Exterior dimensions:
 43 3/8" H
 50 3/4" W
 31 3/4" D
 Maximum log length:
 25"



Optional: forced air distribution kit controlled by wall thermostat (see page 30).
 Optional: 6" x 25' insulated flex pipe for forced air distribution kit.



Premium quality 176 CFM heat activated blower with variable speed control included.



Option: warm air circulation grille - modern style.

*See the complete technical data on page 27.

Technical data: Wood fireplace

GENERAL FEATURES: WOOD FIREPLACE



MODELS	Stratford	Everest	Horizon
Color	Metallic black	Metallic black	Metallic black
Maximum burn time (note 1)	9 hours	9 hours	10 hours
Combustion technology	Non-Catalytic	Non-Catalytic	Non-Catalytic
Recommended heating area (note 1)	750 to 2,100 sq. ft.*	750 to 2,200 sq. ft.*	1,000 to 2,800 sq. ft.*
Maximum heat output - dry cordwood	75,000 BTU/h (22.0 kW)	80,000 BTU/h (23.5 kW/h)	95,000 BTU/h (27.8 kW)
Overall heat output rate (min. to max.)	11,500 BTU/h (3.4 kW) to 30,500 BTU/h (8.9 kW)	13,622 BTU/h (4.0 kW) to 28,629 BTU/h (8.4 kW)	16,610 BTU/h (4.9 kW) to 43,021 BTU/h (12.6 kW)
Door opening dimensions (W x H)	25 1/2" x 10 7/8"	20 3/4" x 10 7/8"	33" x 12 3/4"
Firebox dimensions (W x D x H)	20 7/8" x 12 7/8" x 12"	18 7/8" x 17" x 16 7/8"	25 3/8" x 17 7/8" x 17"
Firebox volume	2.5 cu. ft..	3.1 cu. ft.	4.28 cu. ft.
Average particulate emissions rate	4.4 g/h	2.3 g/h	1.6 g/h
Glass viewing area (W x H)	22 1/4" x 12 3/8"	18 3/4" x 11 3/8"	29 3/4" x 13 1/2"
Door frame	Double, glass with cast iron frame	Double, glass with cast iron frame	Double, glass with cast iron frame
Maximum log length	21"	16"	25"
Log positioning	East-west	East-west	East-west
Optimum efficiency	75 %	73.9 %	69.7 %
Mobile home approved	No	No	No
Flue spigot diameter	6"	6"	8"
Glass type	Ceramic glass	Ceramic glass	Ceramic glass
Adjustable handle	Yes	Yes	Yes
Self-cleaning glass system	Yes	Yes	Yes
Warranty	Lifetime, limited	Lifetime, limited	Lifetime, limited
Test standard - Safety	As per ULC-S610/UL 127 applicable in Canada and in the USA		
Test standard - Emissions / efficiency	EPA / CSA B415.1-10	CSA B415.1-10	EPA / CSA B415.1-10

*With forced air distribution kit.

Note 1 : Recommended heating area and maximum burn time may vary subject to location in home, chimney draft, heat loss factors, climate, fuel type and other variables. The recommended heated area for a given appliance is defined by the manufacturer as its capacity to maintain a minimum acceptable temperature in the designated area in case of a power failure.

Technical data contained in this brochure are for reference only. Any installation must be done according to the data and drawings detailed in the owner's manual.

SPECIFIC FEATURES: WOOD FIREPLACE



MODELS	Stratford	Everest	Horizon
--------	-----------	---------	---------

Exterior dimensions (including spacers) and weight

Height	47 1/8"	40 5/8"	43 3/8"
Width	37 7/8"	37 1/8"	50 3/4"
Depth	29 5/8"	29 1/4"	31 3/4"
Weight	424 lb (192 kg)	435 lb (198 kg)	550 lb (250 kg)

Clearances to combustible materials (see image below)

A- Side wall	17"								21"								24"							
Back wall	0"								0"								0"							
Sides	0"								0"								0"							
Floor (under the fireplace)	0"								0"								0"							
Ceiling	80"								84"								84"							
Non combustible surround (top)	24"								0"								84"							
Non combustible surround (sides)	1 1/4"								0"								3 1/16"							
B- Combustible mantle shelf dimension	6"	8"	10"	12"	6"	8"	10"	12"	6"	8"	10"	12"	N/A											
Minimum clearance from a combustible mantle shelf (from the base of the fireplace)	58"	60"	62"	64"	60"	62"	64"	66"	60"	62"	64"	66"	N/A											
C- Side mantle	3"								N/A								8"							
D- Minimum floor protection — front	16"								16"								32"							
E- Minimum floor protection — width	41 1/2"								36 3/4"								49"							

Black cast iron door overlay	Optional	Optional	Included
Brushed nickel plated cast iron door overlay	Optional	Optional	N/A
Traditional style faceplate	Optional	Included	N/A
Traditional faceplate with brushed nickel accents	Optional	N/A	N/A
Prairie style faceplate	Optional	N/A	Optional
Hot air gravity distribution kit - traditional style (see page 30)	Optional	Optional	N/A
Hot air gravity distribution kit - modern with adjustable pipes (see page 30)	Optional	N/A	N/A
Forced air distribution kit (see page 30)	Optional	Optional	Optional
Warm air circulation grille – modern style	N/A	N/A	Optional
Rigid firescreen	Optional	Optional	N/A

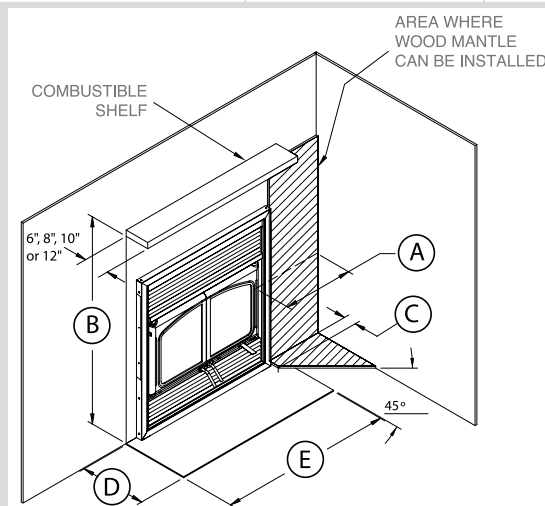

Technical data contained in this brochure are for reference only. Any installation must be done according to the data and drawings detailed in the owner's manual.

LISTED CHIMNEYS, MANUFACTURERS, BRANDS AND TYPES (see note 2): WOOD FIREPLACE

MANUFACTURERS	BRANDS	TYPES	Stratford	Everest	Horizon
Olympia Chimney	Ventis	1" Solid Pack	X	X	X
SBI Venting Division	Nexvent	1" Solid Pack	X	X	X
American Metal	HSS	AC Triple Wall	X	X	X
American Metal	HS	AC Triple Wall	X	X	X
ICC	Excel 2100	1" Solid Pack	X		
M&G DuraVent	Dura Tech	1" Solid Pack	X		
M&G DuraVent	Dura Tech Canada DTC	1" Solid Pack	X		
M&G DuraVent	Dura Plus HTC	2" Solid Pack	X	X	X
M&G DuraVent	Dura Plus	AC Triple Wall	X	X	X
Metal Fab	Temp Guard	1" Solid Pack	X		
Security Chimney	ASHT+	1" Solid Pack	X		
Security Chimney	S-2100 +	2" Solid Pack	X	X	X
Selkirk	UltimateOne	1" Solid Pack	X		
Selkirk	Ultra-Temp (UT)	1" Solid Pack	X		
Selkirk	Super Pro (SPR)	1" Solid Pack	X		
Selkirk	Super Vent (JSC)	1" Solid Pack	X		
Selkirk	Hart & Cooley (TLC)	1" Solid Pack	X		
Selkirk	Sure-Temp (ST)	1" Solid Pack	X		
Selkirk	Super Vent 2100 (JM)	2" Solid Pack	X	X	X
Selkirk	CF Sentinel (CF)	2" Solid Pack	X	X	X
Selkirk	Super Pro 2100 (ALT)	2" Solid Pack	X	X	X

Note 2 : Specific components may be required depending on the chimney manufacturer.

Technical data contained in this brochure are for reference only. Any installation must be done according to the data and drawings detailed in the owner's manual.

IT'S NOW TIME TO MANAGE HEAT DISTRIBUTION!

EPA certified wood fireplaces generate a lot of heat. For the most part, they generate too much for the room where they are located. Therefore, you need to manage the excess heat and send it where it is needed. To provide a solution, our research and development laboratory has designed the HEAT MANAGEMENT SYSTEM, an innovative technology that allows the recovery of the heat produced during combustion to redirect it into distribution ducts to heat other areas in your home.

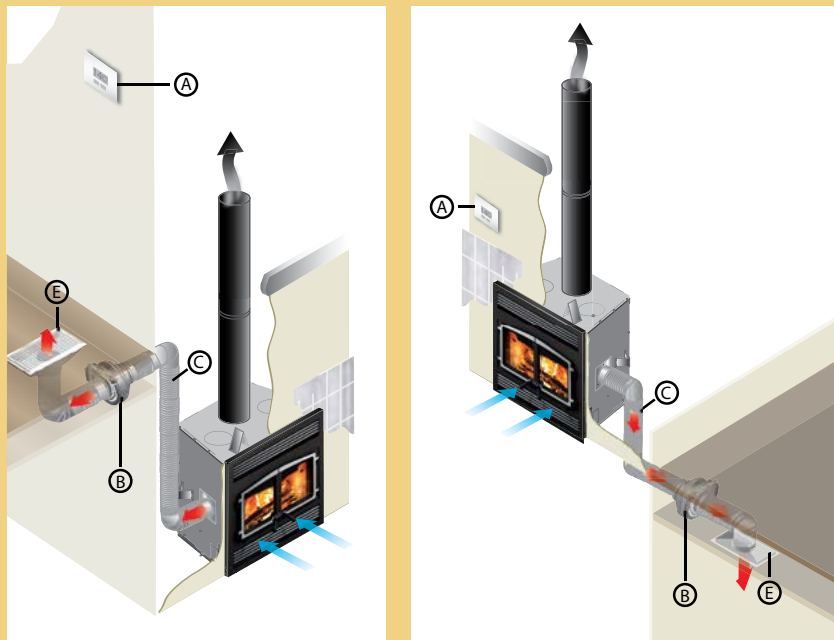

Forced air distribution kit

This system allows you to manage the heat distribution automatically. Using a wall thermostat, you can select the temperature you want to maintain in the room where the fireplace is located. Once the thermostat is satisfied, the excess heat is redirected to another room up to 50 feet (15 m) away from the fireplace using a 300 CFM blower. That way, you can enjoy a nice fire in your living room without the discomfort of excess heat generated by your Osburn fireplace.

The system can also be used to supplement heat in a room remote from the fireplace. For this type of application, the thermostat needs to be positioned in the desired room and programmed with the temperature to be maintained. The system, now in “heat mode”, will activate the blower as long as the temperature in the remote room is not achieved and that the fireplace has enough heat to distribute.

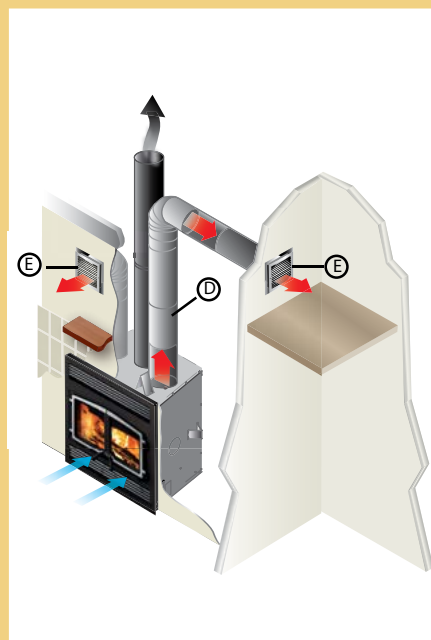

Osburn also offers you another way to distribute excess heat into your home with the help of a hot air gravity distribution kit.

Hot air gravity distribution kit

The hot air gravity distribution kit allows you to bring hot air into the same room as the fireplace, in adjacent rooms, or up-stairs at a maximum distance of 10' (3 m). The minimum height of the hot air duct must be 68" (1.7 m) measured from the base of the fireplace to the top of the hot air register.

Suggested installation : A) Wall thermostat B) 300 CFM blower C) Hot air flexible pipe D) Hot air rigid pipe E) Air register.

The information contained in this page is for information purposes only. For a detailed part list of kits content, please refer to the owner's manuals.

For more details about the installation requirement of the **forced air distribution kit** or the **hot air gravity distribution kit**, visit www.osburn-mfg.com/en/service-support/heat-distribution-system

ABOUT PELLET HEATING





Pellet stoves offer a dramatic improvement in the convenience of heating with solid fuel. Wood pellets are handled in bags and are therefore easily and cleanly stored. A single loading of a pellet stove can provide long hours of warmth. Pellet stoves also provide a special comfort associated with wood burning. The combination of fans delivering warm air currents and the direct comfort of radiant heat provides special satisfaction on a cold winter day. The heat provided is even and constant, due to the auto fuel feed responding to owner settings. Pellet stoves also offer strong environmental benefits; pellets not only reduce dependence on finite supplies of fossil fuels like oil and gas, but they also put to good use materials that would otherwise unnecessarily and expensively add to our waste disposal problems.

In addition, pellet stoves burn very cleanly and offer the lowest emissions of unwanted pollutants of all solid fuel burning appliances.

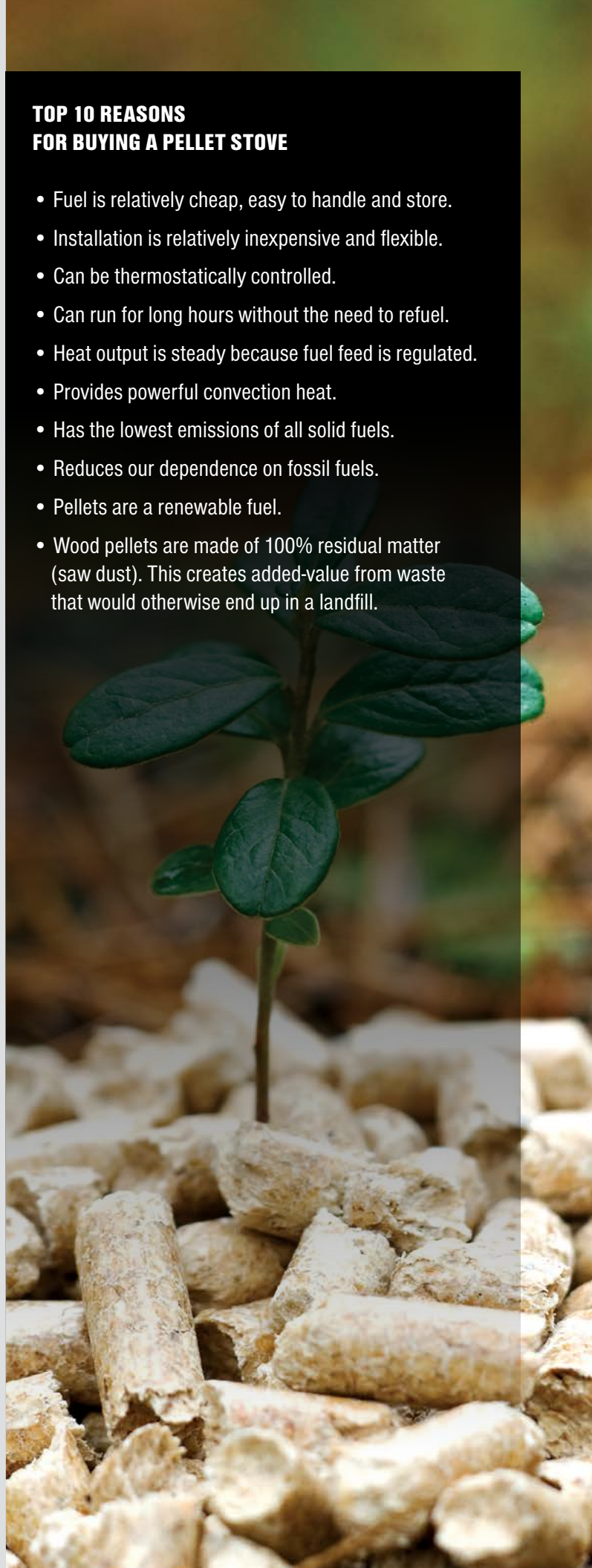
TOP 10 REASONS FOR BUYING A PELLET STOVE

- Fuel is relatively cheap, easy to handle and store.
- Installation is relatively inexpensive and flexible.
- Can be thermostatically controlled.
- Can run for long hours without the need to refuel.
- Heat output is steady because fuel feed is regulated.
- Provides powerful convection heat.
- Has the lowest emissions of all solid fuels.
- Reduces our dependence on fossil fuels.
- Pellets are a renewable fuel.
- Wood pellets are made of 100% residual matter (saw dust). This creates added-value from waste that would otherwise end up in a landfill.



Size	Fuel	Recommended heating area	Maximum heat input rate			
M		500 — 2,000 sq. ft.*	39,260 BTU/h			



new

2500

OP00025

Emissions
0.96 g/h

Optimum efficiency
78.4 %

2500 pellet stove

BEYOND

EFFICACY



Wolf Creek Southern LedgeStone
CULTURED STONE®
BY BORAL®

Loading capacity:
60 lb.



Premium quality 176 CFM blower included.

Full size ash drawer.

Exterior dimensions:
33" H
25 7/8" W
30" D



Optional: 3" fresh air intake kit.

Optional: 3", 10 feet, flexible insulated fresh air intake pipe.

The new Osburn 2500 pellet stove is an entry-level appliance, roughly comparable to the 3000 model, whose appearance is more like that of a conventional wood stove. Although slightly different in some respects than its congener, it still retains the same distinctive signs of the brand.

This pellet stove is **made from high-quality materials**: Canadian steel of a higher grade, glass ceramic imported from Germany, heat exchangers made of stainless steel and thermosetting powder paint. Despite these real assets, worthy of a remarkable design, this product is offered at a **very competitive price** in addition to being eligible for certain credits and programs (government incentives).

Responding largely to the next highest standards of solid fuels and environmental protection, the Osburn 2500 has an incredibly low average of **particles emission rate below 0.96 g/h**.

Thanks to **easy installation**, intuitive electronic control and easy to use thermostatic control, the Osburn 2500 is for anyone who wants nothing complicated. It is also **easy to clean** with access to removable components without tools.

*See the complete technical data on page 33.

**See note 3 on page 33.

GENERAL FEATURES: PELLET STOVE

MODEL	Osburn 2500
Color	Metallic black
Maximum burn time (note 1)	51 hours
Recommended heating area (note 1)	500 to 2,000 sq. ft
Maximum heat input rate (note 2)	39,260 BTU/h (11.5 kW)
Overall heat output rate (min. to max.) (note 2)	6,648 BTU/h (1.9 kW) to 28,540 BTU/h (8.3 kW)
Hopper capacity (note 2)	60 lb (27 kg)
Combustion technology	Top-feed
Number of intensity levels	6
Electronic igniter	Yes
Glass surface – dimensions (Width x Height)	17 1/4" x 9 1/2"
Approved vent diameter	3" or 4" (as per ELV)
Glass type	Ceramic glass
Ash drawer	Yes
Approved for a mobile home installation (note 3)	Yes
Warranty	Limited lifetime
Average particulate emissions rate	0.96 g/h
Optimum efficiency	78.4 %
Noise level at 6 feet	Min: 47 dBa (+/- 3 dBa) – Max: 60 dBa (+/- 3 dBa)
Test standard - safety	ULC S627, CSA B365, ASTM E1509, UL 1482, NFPA 211
Test standard - emissions	EPA / CSA B415.1-10
Exterior dimensions and weight	
Height	33"
Width	25 7/8"
Depth	30"
Weight	276 lb (125 kg)
3" Fresh air intake kit	Optional
3" Fresh air intake adapter	Included

CLEARANCES TO COMBUSTIBLE MATERIALS*		
	CANADA	USA
A**	3"	3"
B	6"	6"
C	3"	3"
D	Refer to vent manufacturer's clearances	
E***	48"	48"
FLOOR PROTECTION		
F	6" ****	6"
G	6" ****	6"

CAUTION:
THE STOVE MUST BE PLACED ON A CONTINUOUS (GROUTED JOINTS) NON COMBUSTIBLE MATERIAL SUCH AS CERAMIC TILE †, CEMENT BOARD, BRICK, MILLBOARD OR EQUIVALENT, OR ANY OTHER APPROVED OR LISTED MATERIAL SUITED FOR FLOOR PROTECTION.

† Any type of tile will require a continuous non combustible sheet beneath to prevent the possibility of embers falling through to the combustible floor if cracks or separation should occur in the finished surface, this would include floor protection for built-in raised hearths. Check local codes for approved alternatives.



* We recommend leaving 24" on each side of the stove and 12" at the back of the stove in order to facilitate access for maintenance. ** From the rear panel. *** Measured from the platform on which the product is installed. **** In Canada, the dimensions of the floor protection can be used ONLY if opening the appliance door or removing the ash drawer is done when the appliance is OFF completely, meaning there is no more fire in the combustion pot and the blowers are off. In all other cases, see CSA B365 standard.

Note 1: Recommended heating area and maximum burn time may vary subject to location in home, chimney draft, heat loss factors, climate, fuel type, feed rate, fuel level, and other variables. The recommended heated area for a given appliance is defined by the manufacturer as its capacity to maintain a minimum acceptable temperature considering that the space configuration and the presence of heat distribution systems have a significant impact in making heat circulation optimum.

Note 2: May vary depending on pellet size and/or density.

Note 3: Fresh air intake kit required.

Technical data contained in this brochure are for reference only. Any installation must be done according to the data and drawings detailed in the owner's manual.

Size	Fuel	Recommended heating area	Maximum heat input rate			
M		500 — 2,200 sq. ft.*	43,000 BTU/h			



new

3000

OP00030

Emissions
2.9 g/h

Optimum efficiency
77.2 %

3000 pellet stove

BEYOND
PERFORMANCE



**Aspen
Southern LedgeStone
CULTURED STONE®
BY BORAL®**

Loading capacity:
55 lb.



Premium quality 176 CFM blower included.

Full size ash drawer.

Exterior dimensions:
32 5/8" H
24 3/8" W
30 5/8" D



Optional: 3" fresh air intake kit.

Optional: 3", 10 feet, flexible insulated fresh air intake pipe.

If you love the look and feel of a wood stove, but are attracted to the convenience offered by pellets, then the new OSBURN 3000 PELLET STOVE is for you.

The Osburn 3000 displays a **classic wood stove appearance**, and is aesthetically consistent with other members of the Osburn product family. However, within this classic wood stove design exists state-of-the-art components for achieving the **unparalleled performance and convenience of a pellet stove**. Notable internal features include a **bottom-feed fuel delivery system**, sophisticated electronics for greater convenience and an air wash system for keeping the large glass viewing door clean. **The new Osburn 3000, a must for eco-friendly heating!**

*See the complete technical data on page 35.
**See note 3 on page 35.

GENERAL FEATURES: PELLET STOVE

MODEL	Osburn 3000
Color	Metallic black
Maximum burn time (note 1)	45 hours
Recommended heating area (note 1)	500 to 2,200 sq. ft
Maximum heat input rate (note 2)	43,000 BTU/h (12.6 kW)
Overall heat output rate (min. to max.) (note 2)	6,400 BTU/h (1.9 kW) to 29,300 BTU/h (8.6 kW)
Hopper capacity (note 2)	55 lb (25 Kg)
Combustion technology	Bottom-feed
Number of intensity levels	12
Electronic igniter	Yes
Glass surface – dimensions (Width x Height)	13 3/8" x 7 3/4"
Approved vent diameter	3" or 4" (as per ELV)
Glass type	Ceramic glass
Ash drawer	Yes
Approved for a mobile home installation (note 3)	Yes
Warranty	Limited lifetime
Average particulate emissions rate	2.9 g/h
Optimum efficiency	77.2 %
Noise level at 6 feet	Min : 47 dBA (+/- 3 dBa) – Max : 59 dBA (+/- 3 dBa)
Test standard - safety	ULC S627, CSA B365, ASTM E1509, UL 1482, NFPA 211
Test standard - emissions	EPA / CSA B415.1-10
Exterior dimensions and weight	
Height	32 5/8"
Width	24 3/8"
Depth	30 5/8"
Weight	386 lb (175 kg)
3" Fresh air intake kit	Optional
3" Fresh air intake adapter	Included

CLEARANCES TO COMBUSTIBLE MATERIALS*		
	CANADA	USA
A**	3"	3"
B	6"	6"
C	3"	3"
D	Refer to vent manufacturer's clearances	
E***	48"	48"
FLOOR PROTECTION		
F	6" ****	6"
G	6" ****	6"

CAUTION:
THE STOVE MUST BE PLACED ON A CONTINUOUS (GROUTED JOINTS) NON COMBUSTIBLE MATERIAL SUCH AS CERAMIC TILE †, CEMENT BOARD, BRICK, MILLBOARD OR EQUIVALENT, OR ANY OTHER APPROVED OR LISTED MATERIAL SUITED FOR FLOOR PROTECTION.

† Any type of tile will require a continuous non combustible sheet beneath to prevent the possibility of embers falling through to the combustible floor if cracks or separation should occur in the finished surface, this would include floor protection for built-in raised hearths. Check local codes for approved alternatives.

* We recommend leaving 24" on each side of the stove and 12" at the back of the stove in order to facilitate access for maintenance. ** From the rear panel. *** Measured from the platform on which the product is installed. **** In Canada, the dimensions of the floor protection can be used ONLY if opening the appliance door or removing the ash drawer is done when the appliance is OFF completely, meaning there is no more fire in the combustion pot and the blowers are off. In all other cases, see CSA B365 standard.

Note 1 : Recommended heating area and maximum burn time may vary subject to location in home, chimney draft, heat loss factors, climate, fuel type, feed rate, fuel level, and other variables. The recommended heated area for a given appliance is defined by the manufacturer as its capacity to maintain a minimum acceptable temperature considering that the space configuration and the presence of heat distribution systems have a significant impact in making heat circulation optimum.

Note 2 : May vary depending on pellet size and/or density.

Note 3 : Fresh air intake kit required.

Technical data contained in this brochure are for reference only. Any installation must be done according to the data and drawings detailed in the owner's manual.

Size

Fuel

Recommended heating area

Maximum heat input rate

M



500 — 2,000 sq. ft.*

45,600 BTU/h



**Glass hearth pad
44" X 36"**
See page 42

VOLTA

OP00055

Emissions
2.5 g/h

Optimum efficiency
75%

Volta pellet stove with optional LCD touch screen sliding system.

BEYOND

INNOVATION

The Volta, Osburn's newest pellet stove, is a quiet and contemporary model. Its innovative components use direct current (DC) and can now operate using the optional 24 volt auxiliary battery system in the event of a power interruption. The unit can also be easily connected to solar panels or other secondary source of renewable energy. The Volta is the complete package, an environmentally friendly heater that delivers power, efficiency, reliability and cleanliness.



Optional: 24V (2 X 12V) battery kit.

Loading capacity:
60 lb.



Optional: battery holder kit.

Full size ash drawer.

Exterior dimensions:

41 1/8" H
21 3/4" W
28 1/8" D



LCD touch-screen control included.



Optional: LCD touch-screen sliding system.



Convection fans up to 220 CFM included.

Optional: 3" fresh air intake kit.



Optional: 3", 10 feet, flexible insulated fresh air intake pipe.

*See the complete technical data on page 37.

**See note 3 on page 37.

GENERAL FEATURES: PELLET STOVE

MODEL	Osburn Volta
Color	Metallic black
Maximum burn time (note 1)	50 hours
Recommended heating area (note 1)	500 - 2,000 sq. ft.
Maximum heat input rate (note 2)	45,600 BTU/h (13.4 kW)
Overall heat output rate (min. to max.) (note 2)	7,200 BTU/h (2.1 kW) to 24,800 BTU/h (7.3 kW)
Hopper capacity (note 2)	60 lb (27 kg)
Combustion technology	Bottom-feed
Number of intensity levels	Variable
Electronic igniter	Yes
Glass surface – dimensions (Width x Height)	5 3/4" x 10"
Approved vent diameter	3"
Glass type	Ceramic glass
Ash drawer	Yes
Approved for a mobile home installation (note 3)	Yes
Approved for an alcove installation	Yes
Warranty	Limited lifetime
Average particulate emissions rate	2.5 g/h
Optimum efficiency	75%
Noise level at 6 feet	Min: 45 dBa (+/- 3 dBa) – Max: 52 dBa (+/- 3 dBa)
Test standard - safety	ULC S627, CSA B365, ASTM E1509, UL 1482, NFPA 211
Test standard - emissions	EPA / CSA B415.1-10
Exterior dimensions and weight	
Height	41 1/8"
Width	21 3/4"
Depth	28 1/8"
Weight	411 lb (186 kg)
24V (2 X 12V) Battery kit	Optional
Battery holder kit	Optional
LCD touch screen sliding system	Optional
3" Fresh air intake kit	Optional
3" Fresh air intake adapter	Included

CLEARANCES TO COMBUSTIBLE MATERIALS*		
	CANADA	USA
A**	1"	1"
B	4"	4"
C	1"	1"
D	Refer to vent manufacturer's clearances	
FLOOR PROTECTION		
E	18"***	6"
F	N/A (USA only)	6"
G	8"	N/A (Canada only)
H	8"	N/A (Canada only)

CAUTION: THE STOVE MUST BE PLACED ON A CONTINUOUS (GROUTED JOINTS) NON COMBUSTIBLE MATERIAL SUCH AS CERAMIC TILE ‡, CEMENT BOARD, BRICK, MILLBOARD OR EQUIVALENT, OR ANY OTHER APPROVED OR LISTED MATERIAL SUITED FOR FLOOR PROTECTION.

‡ Any type of tile will require a continuous non combustible sheet beneath to prevent the possibility of embers falling through to the combustible floor if cracks or separation should occur in the finished surface, this would include floor protection for built-in raised hearths. Check local codes for approved alternatives.

* We recommend leaving 24" on each side of the stove and 12" at the back of the stove in order to facilitate access for maintenance. ** From the rear panel. *** In Canada, you may reduce to the U.S. floor protection requirements (E) ONLY if the following actions are respected: Allow for the appliance to shut-down and fires to be extinguish. Once completely cool and all blowers have stopped you may proceed with opening the firebox or ash door.

Note 1 : Recommended heating area and maximum burn time may vary subject to location in home, chimney draft, heat loss factors, climate, fuel type, feed rate, fuel level, and other variables. The recommended heated area for a given appliance is defined by the manufacturer as its capacity to maintain a minimum acceptable temperature considering that the space configuration and the presence of heat distribution systems have a significant impact in making heat circulation optimum.

Note 2 : May vary depending on pellet size and/or density.

Note 3 : Fresh air intake kit required.

Technical data contained in this brochure are for reference only. Any installation must be done according to the data and drawings detailed in the owner's manual.

Size

Fuel

Recommended heating area

Maximum heat input rate

M



750 – 2,400 sq. ft.*

47,300 BTU/h



5000

OP00050

Emissions
2.18 g/h

Optimum efficiency
75%

5000 pellet stove with
black door overlay.

BEYOND
INNOVATION

The Osburn 5000 pellet stove is the result of Osburn's evolution in the design of advanced combustion systems using solid fuel sources. With its bottom feed technology, the Osburn 5000 offers an impressive reliability and flexibility regardless of the type of pellets you burn. The touch-screen control panel provides infinite possibilities while keeping the operation surprisingly simple. The clean and vertical look of the Osburn 5000 brings a modern touch to your decor without any compromise on the heat output and efficiency.



Required: black or brushed nickel plated cast iron door overlay.

Loading capacity:
70 lb.



Premium quality 200 CFM blower included.

Full size ash drawer.

Exterior dimensions:
36 1/2" H
23 5/8" W
31 1/2" D



LCD touch-screen control included.



Optional: 3" fresh air intake kit.

Optional: 3", 10 feet, flexible insulated fresh air intake pipe.

GENERAL FEATURES: PELLET STOVE

MODEL	Osburn 5000
Color	Metallic black
Maximum burn time (note 1)	64 hours
Recommended heating area (note 1)	750 to 2,400 sq. ft
Maximum heat input rate (note 2)	47,300 BTU/h (13.9 kW)
Overall heat output rate (min. to max.) (note 2)	10,300 BTU/h (3.0 kW) to 30,500 BTU/h (8.9 kW)
Hopper capacity (note 2)	70 lb (32 Kg)
Combustion technology	Bottom-feed
Number of intensity levels	Variable
Electronic igniter	Yes
Glass surface – dimensions (Width x Height)	13 1/8" x 10 7/8"
Approved vent diameter	3" or 4" (as per ELV)
Glass type	Ceramic glass
Ash drawer	Yes
Approved for a mobile home installation (note 3)	Yes
Warranty	Limited lifetime
Average particulate emissions rate	2.18 g/h
Optimum efficiency	75 %
Noise level at 6 feet	Min: 53 dBa (+/- 3 dBa) – Max: 55 dBa (+/- 3 dBa)
Test standard - safety	ULC S627, CSA B365, ASTM E1509, UL 1482, NFPA 211
Test standard - emissions	EPA / CSA B415.1-10
Exterior dimensions and weight	
Height	36 1/2"
Width	23 5/8"
Depth	31 1/2"
Weight	430 lb (195 kg)
Black door overlay	Optional
Brushed nickel plated door overlay	Optional
3" Fresh air intake kit	Optional
3" Fresh air intake adapter	Included

CLEARANCES TO COMBUSTIBLE MATERIALS*		
	CANADA	USA
A**	3"	3"
B	4"	4"
C	3"	3"
D	Refer to vent manufacturer's clearances	
FLOOR PROTECTION		
E	18" ***	6"
F	N/A (USA only)	6"
G	8"	N/A (Canada only)
H	8"	N/A (Canada only)

CAUTION:
THE STOVE MUST BE PLACED ON A CONTINUOUS (GROUTED JOINTS) NON COMBUSTIBLE MATERIAL SUCH AS CERAMIC TILE †, CEMENT BOARD, BRICK, MILLBOARD OR EQUIVALENT, OR ANY OTHER APPROVED OR LISTED MATERIAL SUITED FOR FLOOR PROTECTION.

† Any type of tile will require a continuous non combustible sheet beneath to prevent the possibility of embers falling through to the combustible floor if cracks or separation should occur in the finished surface, this would include floor protection for built-in raised hearths. Check local codes for approved alternatives.



* We recommend leaving 24" on each side of the stove and 12" at the back of the stove in order to facilitate access for maintenance. ** From the rear panel. *** In Canada, you may reduce to the U.S. floor protection requirements (E) ONLY if the following actions are respected: Allow for the appliance to shut-down and fires to be extinguish. Once completely cool and all blowers have stopped you may proceed with opening the firebox or ash door.

Note 1 : Recommended heating area and maximum burn time may vary subject to location in home, chimney draft, heat loss factors, climate, fuel type, feed rate, fuel level, and other variables. The recommended heated area for a given appliance is defined by the manufacturer as its capacity to maintain a minimum acceptable temperature considering that the space configuration and the presence of heat distribution systems have a significant impact in making heat circulation optimum.

Note 2 : May vary depending on pellet size and/or density.

Note 3 : Fresh air intake kit required.

Technical data contained in this brochure are for reference only. Any installation must be done according to the data and drawings detailed in the owner's manual.

Size	Fuel	Recommended heating area	Maximum heat input rate	 
L		1,000 — 2,800 sq. ft. *	70,500 BTU/h	



7000	OP00070	Emissions 2.45 g/h	Optimum efficiency 79.9%	7000 pellet stove with brushed nickel plated door overlay.
-------------	---------	-----------------------	-----------------------------	--

BEYOND
INNOVATION

Osburn increases its leadership in the wood pellet stove market with the Osburn 7000. This stove, which uses a bottom-feed combustion technology, has an impressive hopper capacity of 125 pounds and offers a combustion time of up to 104 hours. Leading edge, the Osburn 7000 has a convenient and intuitive touch screen display offering a world of possibilities to the user. In addition to having a clean line, contemporary design, the Osburn 7000 offers three choices of door overlays to complete its style. This pellet stove, which can produce up to 70,500 BTU/h, can be fitted with a hot air distribution kit to optimize heat distribution throughout the house using a powerful 465 CFM blower.



Required: black or brushed nickel plated cast iron door overlay.

Loading capacity: 125 lb.



Premium quality 500 CFM convection blower included.

Full size ash drawer.

Exterior dimensions:
41 1/4" H
24" W
34 1/2" D



LCD touch-screen control included.



Optional: 3" fresh air intake kit.

Optional: 3", 10 feet, flexible insulated fresh air intake pipe.



Optional: hot air distribution kit.

*See the complete technical data on page 41.
**See note 3 on page 41.

GENERAL FEATURES: PELLET STOVE

MODEL	Osburn 7000
Color	Metallic black
Maximum burn time (note 1)	104 hours
Recommended heating area (note 1)	1,000 to 2,800 sq. ft.
Maximum heat input rate (note 2)	70,500 BTU/h (20.6 kW)
Overall heat output rate (min. to max.) (note 2)	8,300 BTU/h (2.4 kW) to 36,700 BTU/h (10.8 kW)
Hopper capacity (note 2)	125 lb (57 Kg)
Combustion technology	Bottom-feed
Number of intensity levels	Variable
Electronic igniter	Yes
Glass surface – dimensions (Width x Height)	13 1/8" x 10 7/8"
Approved vent diameter	4" (as per ELV)
Glass type	Ceramic glass
Ash drawer	Yes
Approved for a mobile home installation (note 3)	Yes
Warranty	Limited lifetime
Average particulate emissions rate	2.45 g/h
Optimum efficiency	79.9 %
Noise level at 6 feet	Min: 53 dBa (+/- 3 dBa) – Max: 59 dBa (+/- 3 dBa)
Test standard - safety	ULC S627, CSA B365, ASTM E1509, UL 1482, NFPA 211
Test standard - emissions	EPA / CSA B415.1-10
Exterior dimensions and weight	
Height	41 1/4"
Width	24"
Depth	34 1/2"
Weight	468 lb (212 kg)
Black door overlay	Optional
Brushed nickel plated door overlay	Optional
Hot air distribution kit	Optional
3" Fresh air intake kit	Optional
3" Fresh air intake adapter	Included

CLEARANCES TO COMBUSTIBLE MATERIALS*		
	CANADA	USA
A**	3"	3"
B	6"	6"
C	3"	3"
D	Refer to vent manufacturer's clearances	
FLOOR PROTECTION		
E	18" ***	6"
F	N/A (USA only)	6"
G	8"	N/A (Canada only)
H	8"	N/A (Canada only)

CAUTION: THE STOVE MUST BE PLACED ON A CONTINUOUS (GROUTED JOINTS) NON COMBUSTIBLE MATERIAL SUCH AS CERAMIC TILE ‡, CEMENT BOARD, BRICK, MILLBOARD OR EQUIVALENT, OR ANY OTHER APPROVED OR LISTED MATERIAL SUITED FOR FLOOR PROTECTION.

‡ Any type of tile will require a continuous non combustible sheet beneath to prevent the possibility of embers falling through to the combustible floor if cracks or separation should occur in the finished surface, this would include floor protection for built-in raised hearths. Check local codes for approved alternatives.

* We recommend leaving 24" on each side of the stove and 12" at the back of the stove in order to facilitate access for maintenance. ** From the rear panel. *** In Canada, you may reduce to the U.S. floor protection requirements (E) ONLY if the following actions are respected: Allow for the appliance to shut-down and fires to be extinguish. Once completely cool and all blowers have stopped you may proceed with opening the firebox or ash door..

Note 1: Recommended heating area and maximum burn time may vary subject to location in home, chimney draft, heat loss factors, climate, fuel type, feed rate, fuel level, and other variables. The recommended heated area for a given appliance is defined by the manufacturer as its capacity to maintain a minimum acceptable temperature considering that the space configuration and the presence of heat distribution systems have a significant impact in making heat circulation optimum.

Note 2: May vary depending on pellet size and/or density.

Note 3: Fresh air intake kit required.

Technical data contained in this brochure are for reference only. Any installation must be done according to the data and drawings detailed in the owner's manual.

NEW HEARTH PAD PROTECTION SYSTEMS & CERTIFIED MODULAR HEAT SHIELD



AC02703*

AC02704*

AC02711*

AC02710*

*Check local codes for approved alternatives. Any installation must be done according to the data and drawings detailed in the owner's manual.

FIREPLACE TOOL SETS



CODE: # AC02620



CODE: # AC02621



CODE: # AC02622



CODE: # AC02623

DUPLEX

Contains four instruments: poker, broom, shovel and clamp. The clean lines and combination of steel and wood construction make a strong contemporary design statement.
Height of accessories:
19 1/2" (50 cm)
Made in France.

INEO

Contains four instruments: poker, broom, shovel and clamp. The clean lines and simplicity make a strong contemporary design statement.
Height of accessories:
19 1/2" (50 cm)
Made in France.

PAPYRUS

Contains four instruments: poker, broom, shovel and clamp. The dramatic use of steel makes a strong contemporary design statement.
Height of accessories:
19 1/2" (50 cm)
Base diameter:
7 1/2" (19 cm)
Made in France.

TORSADE

Contains four instruments: poker, broom, shovel and clamp. The elegant curved steel makes a strong contemporary design statement.
Height of stand:
22 1/2" (57 cm)
Base diameter:
7 1/2" (19 cm)
Made in France.

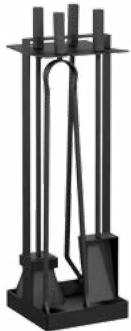

CODE: # AC02624



CODE: # AC02625



CODE: # AC02627



CODE: # AC02350

ABRIK

Contains four instruments: poker, broom, shovel and clamp. The clean lines and the geometric sides and base make a strong contemporary design statement.
Height of stand:
22 1/2" (57 cm)
Dimensions of square base:
7" (18 cm) X 7" (18 cm)
Made in France.

SILHOUETTE

Contains four instruments: poker, broom, shovel and clamp. The simple yet dramatic shape, along with stainless steel handles, make a strong contemporary design statement.
Height of stand:
22 1/2" (55 cm)
Length: 13 1/4" (34 cm)
Depth: 6" (15 cm)
Made in France.

FUSIO LOG HOLDER

This distinctive log holder combines steel and beech wood, and can be set in two positions. Its curved shape makes a strong contemporary design statement. Make your life simpler by fueling your fire without ever being caught unprepared.
Height: 22 1/2" (55 cm)
Length: 18 1/2" (47 cm)
Depth: 22 1/2" (55 cm)
Weight: 17 1/2 lb (8 kg)
Made in France.

EQUISS LOG HOLDER

Made of high quality steel. Its integrated handles make handling easier. Two identical parts that intersect easily. Assembly and disassembly in seconds for compact storage.
Height: 15 1/4" (38 cm)
Length: 24 1/4" (61 cm)
Depth: 13" (33 cm)
Weight: 28 1/2 lb (13 kg)
Made in Canada.

Limited **LIFETIME**
Warranty



SCHOTT
ROBAX®

OSBURN
LIMITED LIFETIME
WARRANTY



on Robax Ceramic Glass

The OSBURN-SCHOTT ROBAX system is one of the highest quality glass and heater product combination on the market. This allows OSBURN to offer a Limited Lifetime Warranty on Robax ceramic glass for all OSBURN appliances.

Conducted consumer studies identify that people want an unobstructed view of the fire, but without compromising safety. The glass “shield” is seen as the needed protection from the fire’s unpredictable aspects. OSBURN chose the SCHOTT ROBAX solution delivering all of the benefits that a consumer wants out of a fire but without the risks associated to it.

Because the way the entire system works together (SCHOTT ROBAX ceramic glass and OSBURN technology), it is the most efficient glass solution available in the market given its high IR transmission values and its high temperature resistance. A high IR transmission means that the heat produced inside the firebox is transferred through the glass more efficiently. The OSBURN-SCHOTT ROBAX ceramic glass can withstand the highest temperatures of any glass on the market.

For more details go to:

www.osburn-mfg.com

WHY choose



RUGGED steel

- **5/16"** top thickness
- **EXTENDED HEAT** radiation

C-CAST baffle

- Space shuttle **QUALITY**
- Resistant up to **2800°F**

CERAMIC glass

- **ALL AROUND** solid glass retainer system
- **LIFETIME WARRANTY** even on accidental breakage

HIGH DENSITY firebricks

- **Impact RESISTANT**
- Superior **HEAT RELEASING** capabilities

MADE IN CANADA
NORTH AMERICAN STEEL



PUB047A

