

WXS2021

 MERIT SERIES EPA WOOD BURNING STOVE















**Superior**<sup>™</sup>  
FIREPLACES  
*Our name is our promise.*

**TRADITIONAL**

The WXS2021 Wood Burning Stove focuses on providing a home heating solution that is dependable and economical.

**FEATURES**

-  Rugged steel stove with ceramic glass door for optimum heat transfer
-  EPA phase II certified and Washington State approved wood heater
-  2.1 cubic foot firebox that accepts up to 20" log size
-  Includes real firebrick and integrated ash lip
-  Combustion air control lever
-  Steel door heats up to 2,000 square feet\*
-  Efficient air wash system that keeps glass clean
-  Steel door with heat resistant door handle that stays cool to the touch
-  Optional variable speed blower and outside air kits available
-  Durable high temperature paint finish
-  Uses 6" single wall or double wall stove pipe
-  20 year limited warranty

\* Square-foot heating capacities and burn times are approximations only. Actual performance may vary depending upon home design and insulation, ceiling heights, climate, condition and type of wood used, appliance location, burn rate, accessories chosen, chimney installation and how the appliance is operated.

## STOVE CLEARANCES

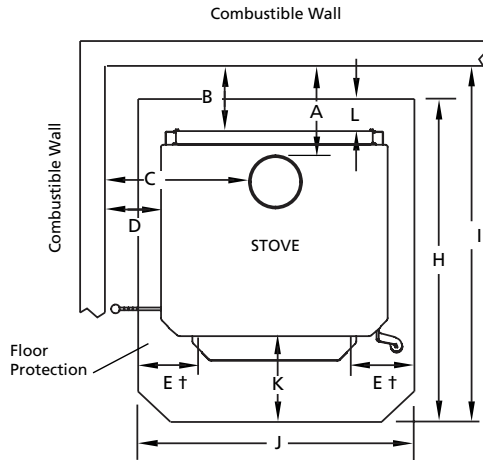

† USA = 8" from door opening,  
Canada = 8" from sides and back of unit

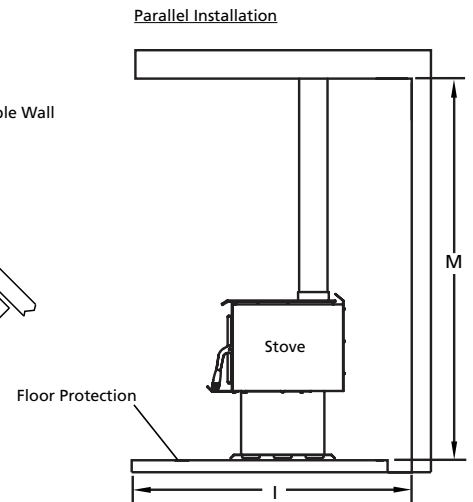
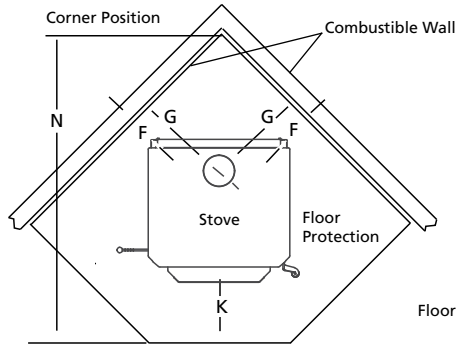

### STOVE CLEARANCES

	U.S. Single-Wall Connector	U.S. Double-Wall Connector	Canada Single-Wall Connector	Canada Double-Wall Connector
A	14-1/4"	12"	14-1/4"	12"
B	11-5/8"	9-3/8"	11-5/8"	9-3/8"
C	22-1/2"	19"	22-1/2"	19"
D	13-3/16"	9-5/8"	13-3/16"	9-5/8"
E	8"	8"	8"	8"
F	9"	6"	9"	6"
G	18"	15"	18"	15"
H	37-7/16"	37-7/16"	47-7/16"	47-7/16"
I	49"	46-3/4"	51"	48-3/4"
J	34-3/4"	34-3/4"	40-7/8"	40-7/8"
K	16"	16"	18"	18"
L	0"	0"	8"	8"
M	96"	96"	96"	84"
N	61-1/2"	57-5/16"	63-1/2"	59-5/16"

### STOVE SPECIFICATIONS

Max. Log Length	20"
EPA Grams per Hour	3 gr/hr
Heating Capacity	Up to 2,000 sq. ft. *
Max. Output	76,000 BTU/hr
Max. Burn Time	7-9 hours

### STOVE DIMENSIONS

#### WXS2021

WIDTH	25-7/8"
HEIGHT	30-5/16"
DEPTH	23-3/8"
WEIGHT	310 lbs.

\*Square-foot heating capacities and burn times are approximations only. Actual performance may vary depending upon home design and insulation, ceiling heights, climate, condition and type of wood used, appliance location, burn rate, accessories chosen, chimney installation and how the appliance is operated.



© 2014 Innovative Hearth Products

785461M 07/14

Visit us online



SuperiorFireplaces.us.com

