

MANTEL ASSEMBLY INSTRUCTIONS

EMBF-1S-(C,DO,O,UH,UO,W)-1

EMBF-3S-(C,DO,O,UH,UO,W)-1

EMBF-5S-(C,DO,O,UH,UO,W)-1

EMBF-7S-(C,DO,O,UH,UO,W)-1

EMBF-2S-(C,DO,O,UH,UO,W)-1

EMBF-4S-(C,DO,O,UH,UO,W)-1

EMBF-6S-(C,DO,O,UH,UO,W)-1

EMBF-8S-(C,DO,O,UH,UO,W)-1

FULL CABINET MANTEL

INSTRUCTIONS MUST BE LEFT WITH THE OWNER FOR FUTURE REFERENCE AFTER INSTALLATION.

1. Place base in desired location. Place fireplace on base and route gas line to fireplace. See Figure 1.

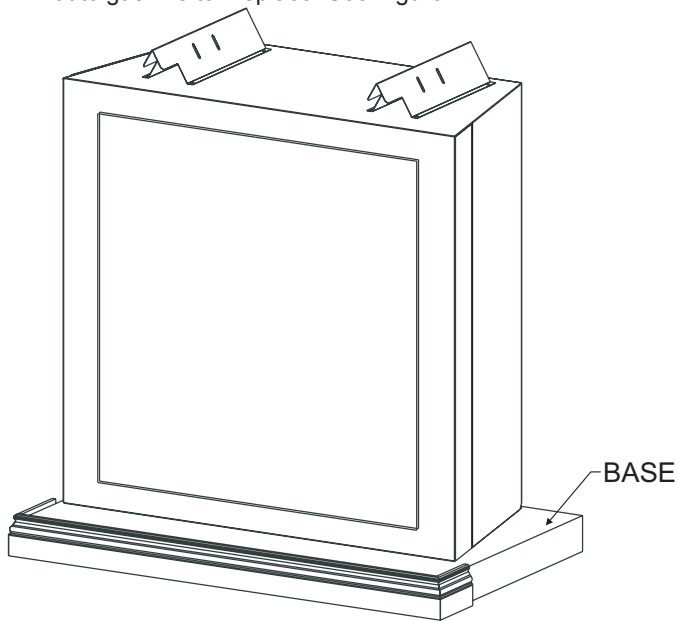

Figure 1

2. Position left side assembly and right side assembly against base. See Figure 2.

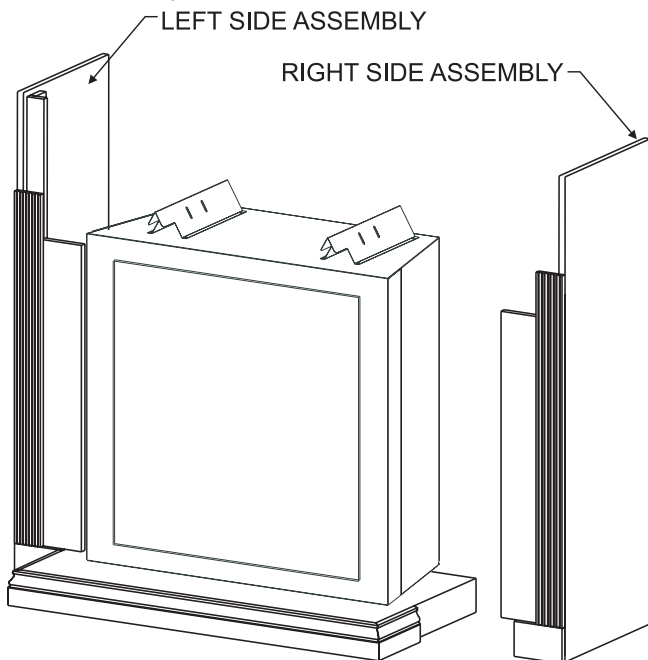

Figure 2

3. Position breastboard assembly to the front of left side assembly and right side assembly. See Figure 3.

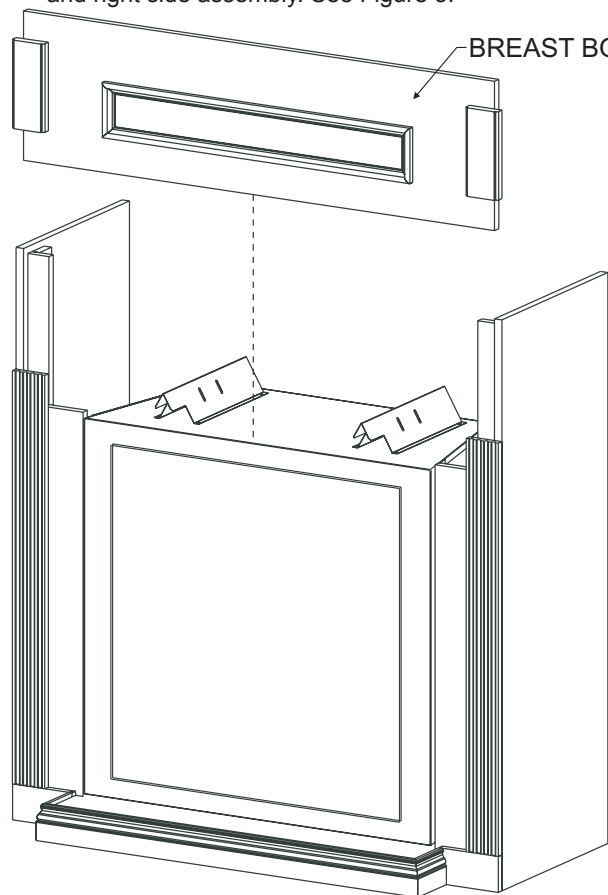

Figure 3

4. Use six (6) 1 1/4" screws to attach breastboard assembly to left side assembly and right side assembly. See Figure 4.

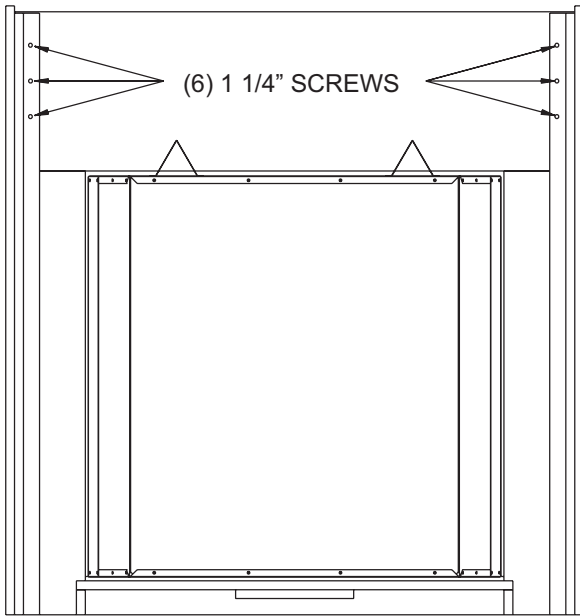

Figure 4

5. Attach "L" Bracket to top of firebox to secure mantel to firebox. See Figure 5.

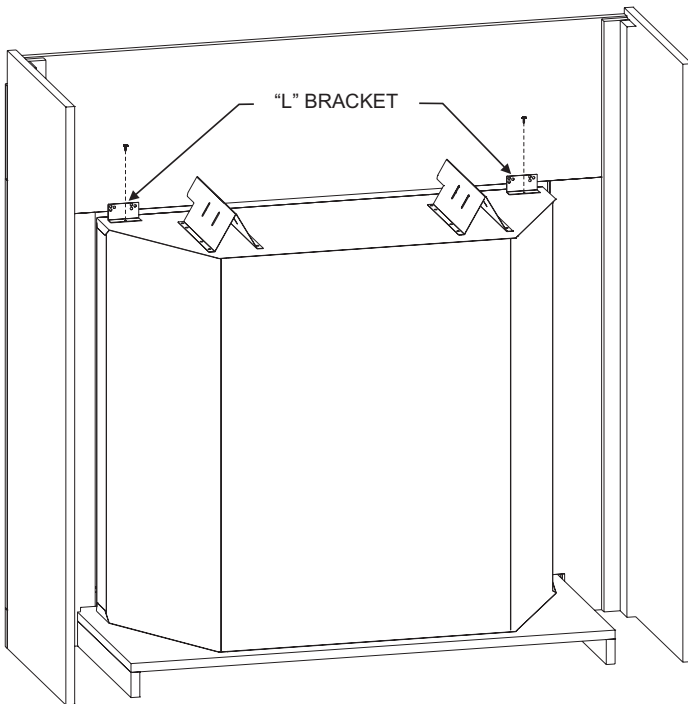

Figure 5

6. Place top assembly onto left side assembly and right side assembly. See Figure 6.

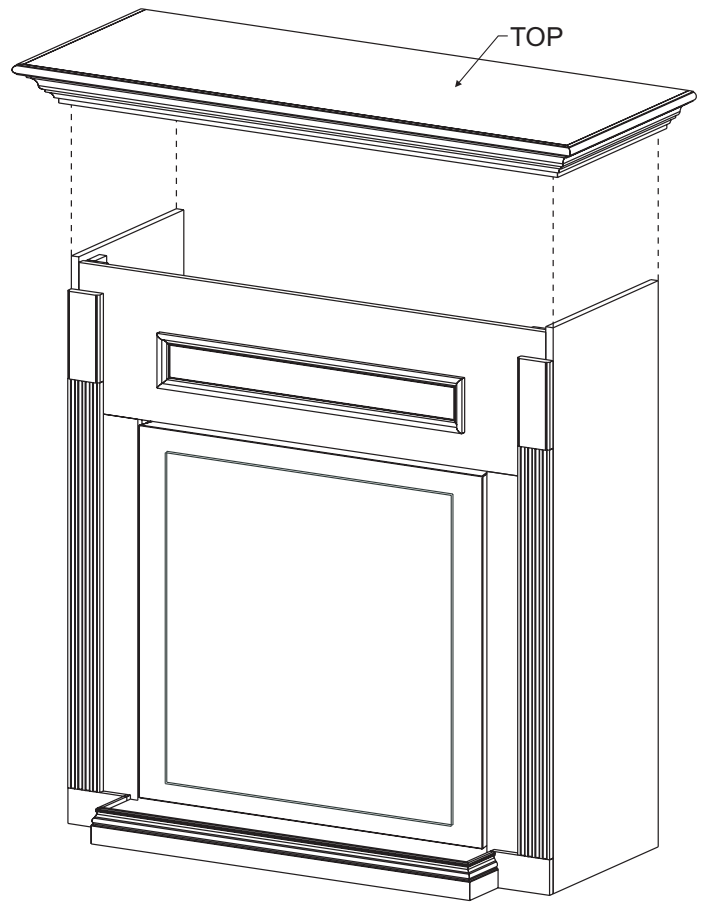

Figure 6

7. Installation of mantel is completed.