

## Specifications

### SV7QLCD-T

|                |                               |
|----------------|-------------------------------|
| Size           | 7" TFT-LCD Monitor            |
| Panel          | Innolux Digital               |
| Aspect ratio   | 16:9                          |
| Resolution     | 800xR.G.Bx480                 |
| System         | PAL/NTSC auto switching       |
| Video/Audio in | 1 video input & 1 audio input |
| Speaker        | yes                           |
| Power range    | DC 9-32V                      |

## Warranty

### TECHNICALSUPPORT

For Technical Support please contact [support.usa@smartwitness.com](mailto:support.usa@smartwitness.com)

### LIMITEDWARRANTY

This product is supplied with a 1 Year warranty. The Warranty excludes products that have been misused (including accidental damage) and damage caused by normal wear and tear. In the unlikely event that you encounter a problem with this product, it should be returned to the place of purchase.



[support.smartwitness.com](http://support.smartwitness.com)



# SV7QLCD-T

## 7" LCD Monitor for Vehicles



### BEFORE YOU BEGIN

- Please unpack the box carefully and identify that all the parts are present.
- The monitor is suitable for indoor applications like car rear vision or CCTV surveillance system.
- Make sure you use the recommended power input. Damage caused to the monitor by incorrect voltage is not covered by the warranty.
- Do not attempt to open the casing to access the monitor. Damage caused to the monitor by tampering with the monitor casing is not covered by the warranty.

**WARNING: SmartWitness installations should be performed by a qualified individual or installation professional only. Working with a vehicle's power system can be dangerous to both you and your vehicle. This installation is intended only to be a guide since vehicle designs and power/input sources can vary significantly from vehicle to vehicle.**

## Product Description

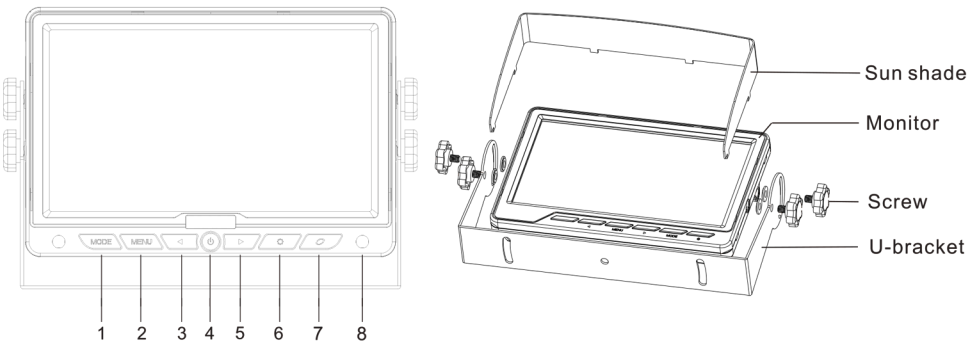

Sun shade  
Monitor  
Screw  
U-bracket

1 2 3 4 5 6 7 8

- 1) Video Select
- 2) Menu
- 3) Increase Button
- 4) Power
- 5) Decrease Button
- 6) Brightness Mode
- 7) Normal/Mirror
- 8) IR receiver

## Remote Control

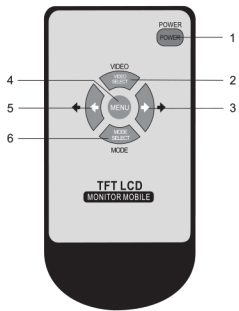

- 1) Power
- 2) Video Select
- 3) Increase Button
- 4) Menu
- 5) Decrease Button
- 6) Mode Selection

## Wiring Connection

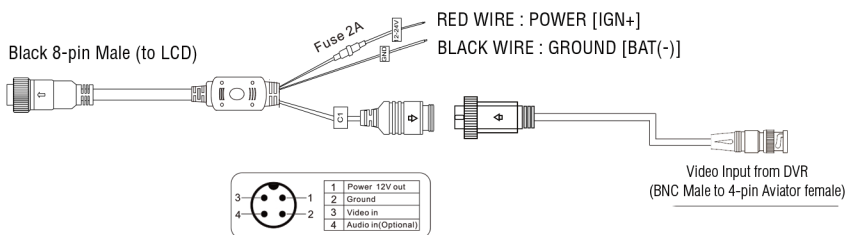

## Monitor Standard Installation

- 1 Remove the adjustable tilt screw completely and remove the monitor from the U Bracket. Place the U bracket to the desired mounting location and prepare the 3 bracket screws

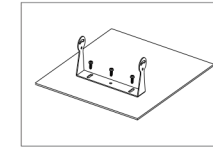
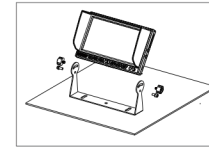



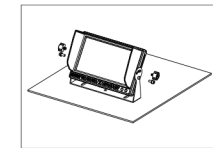
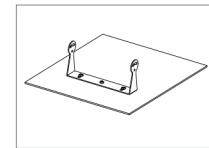

- 2 Secure the bracket with the 3 included screws. Then place the LCD monitor into the bracket and secure again with the adjustable tile screws

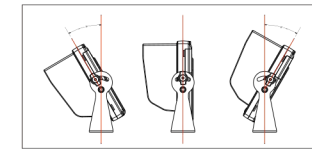
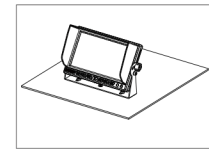

- 3 Adjust the LCD monitor angle by loosening the tilt screws and setting your desired angle. The LCD can be tilted a maximum of 30°, frontward or backward. Tighten tile screws to set the angle

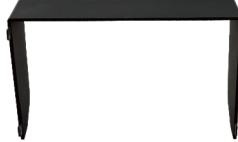

## Included Accessories

|   |  |   |
|---|--|---|
| Remote control x 1 PCS<br> | User manual x 1 PCS<br>         | Power cable x 1 PCS<br>    |
| Sun shade x 1 PCS<br>      | Bracket Accessories x 1 PCS<br> | DVR to LCD Video Cable<br> |