



Installation and Operation Instructions

Superior™ Unvented (Vent-Free) Gas Log Heater

P/N 126828-01 Rev. NC 02/2014



P126828-01



Models

BGE18NE

BGE18PE

BGE2436NE

BGE2436PE

INSTALLER: Leave this manual with the appliance.

CONSUMER: Retain this manual for future reference.

This appliance may be installed in an aftermarket permanently located, manufactured (mobile) home, where not prohibited by local codes. This appliance is only for use with the type of gas indicated on the rating plate. This appliance is not convertible for use with other gases.

WARNING: This appliance is for installation only in a solid-fuel burning masonry or UL127 factory-built fireplace or in a listed ventless firebox enclosure. It is design-certified for these installations in accordance with ANSI Z21.11.2. Exception: DO NOT install this appliance in a factory-built fireplace that includes instructions stating it has not been tested or should not be used with unvented gas logs.

This is an unvented gas-fired heater. It uses air (oxygen) from the room in which it is installed. Provisions for adequate combustion and ventilation air must be provided. Refer to Air for Combustion and Ventilation section on page 6 of this manual.

⚠ WARNING: If the information in these instructions is not followed exactly, a fire or explosion may result causing property damage, personal injury or loss of life.

- Do not store or use gasoline or other flammable vapors and liquids in the vicinity of this or any other appliance.
- **WHAT TO DO IF YOU SMELL GAS:**
 - Do not try to light any appliance.
 - Do not touch any electrical switch; do not use any phone in your building.
 - Immediately call your gas supplier from a neighbor's phone. Follow the gas supplier's instructions.
 - If you cannot reach your gas supplier, call the fire department.
- Installation and service must be performed by a qualified installer, service agency or the gas supplier.

TABLE OF CONTENTS

Safety	2	Wiring Diagram.....	32
Unpacking.....	5	Specifications	32
Product Identification.....	5	Troubleshooting.....	33
Local Codes.....	5	Service Hints	40
Product Features.....	6	Technical Service.....	40
Air For Combustion and Ventilation.....	6	Replacement Parts.....	40
Installation	9	Accessories	40
Operation.....	23	Parts.....	41
Inspecting Burners.....	29	Warranty.....	46
Cleaning and Maintenance.....	30		

SAFETY

⚠ WARNING: Improper installation, adjustment, alteration, service or maintenance can cause injury or property damage. Refer to this manual for correct installation and operational procedures. For assistance or additional information consult a qualified installer, service agency or the gas supplier.

⚠ WARNING: This appliance is for installation only in a solid-fuel burning masonry or UL127 factory-built fireplace or in a listed ventless firebox enclosure. It is design-certified for these installations in accordance with ANSI Z21.11.2. Exception: DO NOT install this appliance in a factory-built fireplace that includes instructions stating it has not been tested or should not be used with unvented gas logs.

⚠ WARNING: This is an unvented gas-fired heater. It uses air (oxygen) from the room in which it is installed. Provisions for adequate combustion and ventilation air must be provided. Refer to *Air for Combustion and Ventilation* section on page 6 of this manual.

This appliance may be installed in an aftermarket,* permanently located, manufactured (mobile) home, where not prohibited by local codes.

This appliance is only for use with the type of gas indicated on the rating plate. This appliance is not convertible for use with other gases.

* Aftermarket: Completion of sale, not for purpose of resale, from the manufacturer

SAFETY

Continued

⚠ WARNING: This product contains and/or generates chemicals known to the state of California to cause cancer or birth defects or other reproductive harm.

IMPORTANT: Read this owner's manual carefully and completely before trying to assemble, operate or service this fireplace. Improper use of this fireplace can cause serious injury or death from burns, fire, explosion, electrical shock and carbon monoxide poisoning.

⚠ DANGER: Carbon monoxide poisoning may lead to death!

Carbon Monoxide Poisoning: Early signs of carbon monoxide poisoning resemble the flu, with headaches, dizziness or nausea. If you have these signs, the fireplace may not be working properly. **Get fresh air at once!** Have fireplace serviced. Some people are more affected by carbon monoxide than others. These include pregnant women, people with heart or lung disease or anemia, those under the influence of alcohol and those at high altitudes.

Natural and Propane/LP gases are odorless. An odor-making agent is added to these gases. The odor helps you detect a gas leak. However, the odor added to the gas can fade. Gas may be present even though no odor exists.

Make certain you read and understand all warnings. Keep this manual for reference. It is your guide to safe and proper operation of this fireplace.

⚠ WARNING: Any change to this heater or its controls can be dangerous.

⚠ WARNING: Do not use a blower insert, heat exchanger insert or other accessory not approved for use with this heater.

⚠ WARNING: Do not allow fans to blow directly into the fireplace. Avoid any drafts that alter burner flame patterns. Ceiling fans can create drafts that alter burner flame patterns. Altered burner patterns can cause sooting.

Due to high temperatures, the appliance should be located out of traffic and away from furniture and draperies.

Do not place clothing or other flammable material on or near the appliance. Never place any objects on the heater.

Heater base assembly becomes very hot when running heater. Keep children and adults away from hot surface to avoid burns or clothing ignition. Heater will remain hot for a time after shutdown. Allow surface to cool before touching.

Carefully supervise young children when they are in the room with heater.

You must operate this heater with the fireplace screen and hood in place. Make sure fireplace screen and hood are in place before running heater. The fireplace screen shall have openings for introduction of combustion air.

Keep the appliance area clear and free from combustible materials, gasoline and other flammable vapors and liquids.

SAFETY

Continued

1. This appliance is only for use with the type of gas indicated on the rating plate. This appliance is not convertible for use with other gases.
2. Do not place propane/LP supply tank(s) inside any structure. Locate propane/LP supply tank(s) outdoors (propane/LP units only).
3. If you smell gas
 - shut off gas supply
 - do not try to light any appliance
 - do not touch any electrical switch; do not use any phone in your building
 - immediately call your gas supplier from a neighbor's phone. Follow the gas supplier's instructions
 - if you cannot reach your gas supplier, call the fire department
4. This heater shall not be installed in a bedroom or bathroom.
5. Before installing in a solid fuel burning fireplace, the chimney flue and firebox must be cleaned of soot, creosote, ashes and loose paint by a qualified chimney cleaner. Creosote will ignite if highly heated. A dirty chimney flue may create and distribute soot within the house. Inspect chimney flue for damage. If damaged, repair flue and firebox before operating heater.
6. Do not burn solid-fuel in a masonry or UL127 factory-built fireplace in which a vent-free room heater is installed.
7. If fireplace has glass doors, never operate this heater with glass doors closed. Any glass doors shall be fully opened when the appliance is in operation. If you operate heater with doors closed, heat buildup inside fireplace will cause glass to burst. Make sure there are no obstructions across openings of fireplace.
8. To prevent the creation of soot, follow the instructions in Cleaning and Maintenance, page 33.
9. Before using furniture polish, wax, carpet cleaner or similar products, turn heater off. If heated, the vapors from these products may create a white powder residue within burner box or on adjacent walls and furniture.
10. This heater needs fresh, outside air ventilation to run properly. This heater has an Oxygen Depletion Sensing (ODS) safety shutoff system. The ODS shuts down the heater if enough fresh air is not available. See Air for Combustion and Ventilation, page 6. If heater keeps shutting off, see Troubleshooting, page 36.
11. Do not run heater
 - where flammable liquids or vapors are used or stored
 - under dusty conditions
12. Do not use this heater to cook food or burn paper or other objects.
13. Do not use heater if any part has been exposed to or under water. Immediately call a qualified service technician to inspect the room heater and to replace any part of the control system and any gas control which has been under water.
14. Do not operate heater if any log is broken. Do not operate heater if a log is chipped (dime-sized or larger).
15. Turn heater off and let cool before servicing, installing or repairing. Only a qualified service person should install, service or repair heater.
16. Make sure the remote is set to the OFF position when you are away from home for long periods of time.
17. Remote heaters must not be connected to any external electrical source.
18. Operating heater above elevations of 4,500 feet may cause pilot outage.
19. To prevent performance problems, do not use propane/LP fuel tank of less than 100 lb. capacity (propane/LP units only).
20. Provide adequate clearances around air openings.

UNPACKING

CAUTION: Do not remove the data plates from the grate assembly. The data plates contain important warranty and safety information.

1. Remove logs and heater base assembly from cartons.

Note: Do not pick up heater base assembly by burners. This could damage heater. Always handle base assembly by grate.

2. Remove all protective packaging applied to logs and heater for shipment.
3. Check heater for any shipping damage. If heater is damaged call INNOVATIVE HEARTH PRODUCTS at 1-800-655-2008 for replacement parts before returning to dealer.

PRODUCT IDENTIFICATION

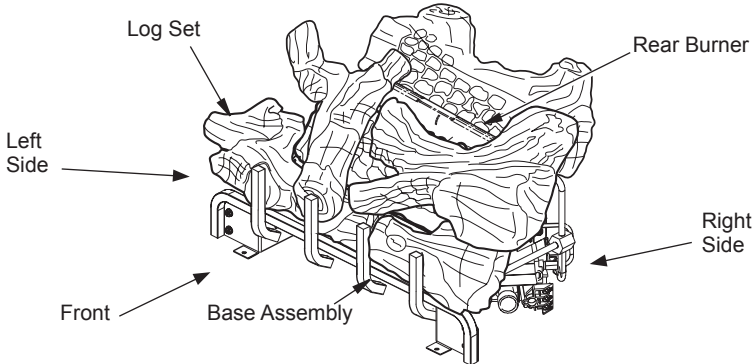

Figure 1 - Product Identification

LOCAL CODES

Install and use heater with care. Follow all local codes. In the absence of local codes, use the latest edition of *The National Fuel Gas Code, ANSI Z223.1/NFPA 54**.

*Available from:

American National Standards Institute, Inc.
1430 Broadway
New York, NY 10018

National Fire Protection Association, Inc.
Batterymarch Park
Quincy, MA 02269

State of Massachusetts: The installation must be made by a licensed plumber or gas fitter in the Commonwealth of Massachusetts.

Sellers of unvented propane or natural gas-fired supplemental room heaters shall provide to each purchaser a copy of 527 CMR 30 upon sale of the unit.

Vent-free gas products are prohibited for bedroom and bathroom installation in the Commonwealth of Massachusetts.

PRODUCT FEATURES

OPERATION

This heater is clean burning. It requires no outside venting. There is no heat loss out a vent or up a chimney. Heat is generated by both realistic flames and glowing coals. This heater is designed for vent-free operation with flue damper closed. It has been tested and approved to ANSI Z21.11.2 standard for unvented heaters. State and local codes in some areas prohibit the use of vent-free heaters.

SAFETY DEVICE

This heater has a pilot with an Oxygen Depletion Sensing (ODS) safety shutoff system. The ODS/pilot is a required feature for vent-free room heaters. The ODS/pilot shuts off the heater if there is not enough fresh air.

ELECTRONIC IGNITION SYSTEM

This heater has an electronic ignitor to light heater fuel supply.

AIR FOR COMBUSTION AND VENTILATION

⚠ WARNING: This heater shall not be installed in a room or space unless the required volume of indoor combustion air is provided by the method described in the *National Fuel Gas Code, ANSI Z223.1/NFPA 54, the International Fuel Gas Code, or applicable local codes. Read the following instructions to insure proper fresh air for this and other fuel-burning appliances in your home.*

Today's homes are built more energy efficient than ever. New materials, increased insulation and new construction methods help reduce heat loss in homes. Home owners weather strip and caulk around windows and doors to keep the cold air out and the warm air in. During heating months, home owners want their homes as airtight as possible.

While it is good to make your home energy efficient, your home needs to breathe. Fresh air must enter your home. All fuel-burning appliances need fresh air for proper combustion and ventilation.

Exhaust fans, fireplaces, clothes dryers and fuel burning appliances draw air from the house to operate. You must provide adequate fresh air for these appliances. This will insure proper venting of vented fuel-burning appliances.

PROVIDING ADEQUATE VENTILATION

The following are excerpts from *National Fuel Gas Code, ANSI Z223.1/NFPA 54, Air for Combustion and Ventilation*.

All spaces in homes fall into one of the three following ventilation classifications:

1. Unusually Tight Construction
2. Unconfined Space
3. Confined Space

The information on pages 6 through 8 will help you classify your space and provide adequate ventilation.

Unusually Tight Construction

The air that leaks around doors and windows may provide enough fresh air for combustion and ventilation. However, in buildings of unusually tight construction, you must provide additional fresh air.

Unusually tight construction is defined as construction where:

- a. **walls and ceilings exposed to the outside atmosphere have a continuous water vapor retarder with a rating of one perm (6×10^{-11} kg per pa-sec- m^2) or less with openings gasketed or sealed and**
- b. **weather stripping has been added on openable windows and doors and**
- c. **caulking or sealants are applied to areas such as joints around window and door frames, between sole plates and floors, between wall-ceiling joints, between wall panels, at penetrations for plumbing, electrical and gas lines and at other openings.**

AIR FOR COMBUSTION AND VENTILATION

Continued

If your home meets all of the three criteria above, you must provide additional fresh air. See Ventilation Air From Outdoors, page 8.

If your home does not meet all of the three criteria above, proceed to Determining Fresh-Air Flow For Heater Location, below.

Confined and Unconfined Space

The National Fuel Gas Code, ANSI Z223.1/NFPA 54 defines a confined space as a space whose volume is less than 50 cubic feet per 1,000 Btu/hr (4.8 m³ per kw) of the aggregate input rating of all appliances installed in that space and an unconfined space as a space whose volume is not less than 50 cubic feet per 1,000 Btu/hr (4.8 m³ per kw) of the aggregate input rating of all appliances installed in that space. Rooms communicating directly with the space in which the appliances are installed*, through openings not furnished with doors, are considered a part of the unconfined space.

* Adjoining rooms are communicating only if there are doorless passageways or ventilation grills between them.

DETERMINING FRESH-AIR FLOW FOR HEATER LOCATION

Determining if You Have a Confined or Unconfined Space

Use this work sheet to determine if you have a confined or unconfined space.

Space: Includes the room in which you will install fireplace plus any adjoining rooms with doorless passageways or ventilation grills between the rooms.

- Determine the volume of the space (length x width x height).

Length x Width x Height = _____ cu. ft.
(volume of space)

Example: Space size 20 ft. (length) x 16 ft. (width) x 8 ft. (ceiling height) = 2560 cu. ft. (volume of space)

If additional ventilation to adjoining room is supplied with grills or openings, add the volume of these rooms to the total volume of the space.

- Multiply the space volume by 20 to determine the maximum Btu/Hr the space can support.

_____ (volume of space) x 20 = (Maximum Btu/Hr the space can support)

Example: 2560 cu. ft. (volume of space) x 20 = 51,200 (maximum Btu/Hr the space can support)

- Add the Btu/Hr of all fuel burning appliances in the space.

Vent-free fireplace	_____ Btu/Hr
Gas water heater*	_____ Btu/Hr
Gas furnace	_____ Btu/Hr
Vented gas heater	_____ Btu/Hr
Gas fireplace logs	_____ Btu/Hr
Other gas appliances*	+ _____ Btu/Hr
Total	= _____ Btu/Hr

* Do not include direct-vent gas appliances. Direct-vent draws combustion air from the outdoors and vents to the outdoors.

Example:

Gas water heater	_____	40,000	Btu/Hr
Vent-free fireplace	+	33,000	Btu/Hr
Total	=	73,000	Btu/Hr

- Compare the maximum Btu/Hr the space can support with the actual amount of Btu/Hr used.

_____ Btu/Hr (maximum can support)

_____ Btu/Hr (actual amount used)

Example: 51,200 Btu/Hr (maximum the space can support)

73,000 Btu/Hr (actual amount of Btu/Hr used)

The space in the above example is a confined space because the actual Btu/Hr used is more than the maximum Btu/Hr the space can support. You must provide additional fresh air. Your options are as follows:

- Rework worksheet, adding the space of an adjoining room. If the extra space provides an unconfined space, remove door to adjoining room or add ventilation grills between rooms. See Ventilation Air From Inside Building, page 8.
- Vent room directly to the outdoors. See Ventilation Air From Outdoors, page 8.
- Install a lower Btu/Hr fireplace, if lower Btu/Hr size makes room unconfined.

If the actual Btu/Hr used is less than the maximum Btu/Hr the space can support, the space is an unconfined space. You will need no additional fresh air ventilation.

AIR FOR COMBUSTION AND VENTILATION

Continued

⚠️ WARNING: If the area in which the heater may be operated does not meet the required volume for indoor combustion air, combustion and ventilation air shall be provided by one of the methods described in the *National Fuel Gas Code, ANSI Z223.1/NFPA 54*, the *International Fuel Gas Code*, or applicable local codes.

VENTILATION AIR

Ventilation Air From Inside Building

This fresh air would come from an adjoining unconfined space. When ventilating to an adjoining unconfined space, you must provide two permanent openings: one within 12" of the ceiling and one within 12" of the floor on the wall connecting the two spaces (see options 1 and 2, Figure 2). You can also remove door into adjoining room (see option 3, Figure 2). Follow the *National Fuel Gas Code, ANSI Z223.1/NFPA 54, Air for Combustion and Ventilation* for required size of ventilation grills or ducts.

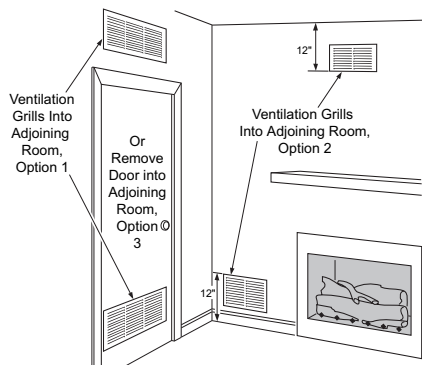

Figure 2 - Ventilation Air from Inside Building

Ventilation Air From Outdoors

Provide extra fresh air by using ventilation grills or ducts. You must provide two permanent openings: one within 12" of the ceiling and one within 12" of the floor. Connect these items directly to the outdoors or spaces open to the outdoors. These spaces include attics and crawl spaces. Follow the *National Fuel Gas Code, ANSI Z223.1/NFPA 54, Air for Combustion and Ventilation* for required size of ventilation grills or ducts.

IMPORTANT: Do not provide openings for inlet or outlet air into attic if attic has a thermostat-controlled power vent. Heated air entering the attic will activate the power vent.

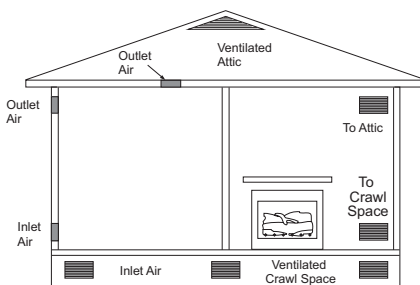

Figure 3 - Ventilation Air from Outdoors

INSTALLATION

NOTICE: This heater is intended for use as supplemental heat. Use this heater along with your primary heating system. Do not install this heater as your primary heat source. If you have a central heating system, you may run system's circulating blower while using heater. This will help circulate the heat throughout the house. In the event of a power outage, you can use this heater as your primary heat source.

WARNING: A qualified service person must install heater. Follow all local codes.

WARNING: Before installing in a solid fuel burning fireplace, the chimney flue and firebox must be cleaned of soot, creosote, ashes and loose paint by a qualified chimney cleaner. Creosote will ignite if highly heated. A dirty chimney flue may create and distribute soot within the house. Inspect chimney and firebox flue for damage. If damaged, repair flue and firebox before operating heater.

WARNING: Any outside air ducts and/or ash dumps in the fireplace shall be permanently closed at time of appliance installation.

WARNING: Seal any fresh air vents or ash clean-out doors located on floor or wall of fireplace. If not, drafting may cause pilot outage or sooting. Use a heat-resistant sealant. Do not seal chimney flue damper.

WARNING: Never install the heater

- in a bedroom or bathroom
- in a recreational vehicle
- where curtains, furniture, clothing or other flammable objects are less than 36" from the front and 42" from top heater, For side clearances see Figure 4 page 10
- in high traffic areas
- in windy or drafty areas

CAUTION: This heater creates warm air currents. These currents move heat to wall surfaces next to heater. Installing heater next to vinyl or cloth wall coverings or operating heater where impurities (such as, but not limited to, tobacco smoke, aromatic candles, cleaning fluids, oil or kerosene lamps, etc.) in the air exist, may discolor walls or cause odors.

IMPORTANT: Vent-free heaters add moisture to the air. Although this is beneficial, installing heater in rooms without enough ventilation air may cause mildew to form from too much moisture. See [*Air for Combustion and Ventilation*](#), page 6.

INSTALLATION

Continued

CHECK GAS TYPE

Use the correct type of gas (natural or propane/LP). If your gas supply is not the correct gas type, do not install heater. Call dealer where you bought heater for proper type heater.

WARNING: This appliance is equipped for either natural gas or propane/LP gas but not both. Gas type is indicated on the rating plate. Field conversion is not permitted.

INSTALLATION AND CLEARANCES FOR VENT-FREE OPERATION

WARNING: Maintain the minimum clearances. If you can, provide greater clearances from floor, ceiling and adjoining wall.

Minimum Fireplace Clearance to Combustible Materials
Side Wall 16", Ceiling 42", Floor 5", Front 36"

LOG SIZING REQUIREMENTS

Log Set Models	Minimum Firebox Size			
	Height	Depth	Front Width	Rear Width*
LBG18-SM	17"	13.5"	20"	14"
LBG24-SM	17"	13.5"	26"	18"
LBG30-SM	21"	13.5"	32"	22"
LBG36-SM	21"	13.5"	38"	27.5"
LBG18-BM	17"	14.5"	26"	20"
LBG24-BM	17"	14.5"	29"	22"
LBG30-BM	21"	14.5"	32"	22"

Carefully follow these instructions. This will ensure safe installation into a masonry, UL127-listed manufactured fireplace or listed vent-free firebox.

Minimum Clearances For Side Combustible Material, Side Wall and Ceiling

A. Clearances from the side of the fireplace cabinet to any combustible material and wall should follow diagram in Figure 4.

Example: The face of a mantel, bookshelf, etc. is made of combustible material and protrudes 3 1/2" from the wall. This combustible material must be 4" from the side of the fireplace cabinet (see Figure 4).

Note: When installing your gas logs into a manufactured firebox, follow firebox manufacturer's instructions for minimum clearances to combustible materials.

B. Clearances from the top of the fireplace opening to the ceiling should not be less than 42".

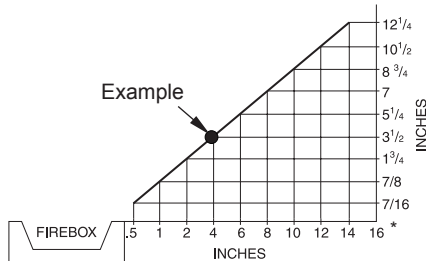

*Minimum 16" from Side Wall

Figure 4 - Minimum Clearance for Combustible to Wall

MINIMUM NONCOMBUSTIBLE MATERIAL CLEARANCES

If Not Using Mantel

Note: If using a mantel proceed to If Using Mantel. If not using a mantel, follow the information on this page.

You must have noncombustible material(s) above the fireplace opening. Noncombustible materials (such as slate, marble, tile, etc.) must be at least 1/2" thick. With sheet metal, you must have noncombustible material behind it. Noncombustible material must extend at least 8" up (for all models). If noncombustible material is less than 12", you must install

INSTALLATION

Continued

the fireplace hood accessory (24", 30" and 36" Models Only). See Figure 5 for minimum clearances.

Noncombustible Material Distance (A)	Requirements for Safe Installation
12" or more	Noncombustible material OK.
Between 8" and 12"	24", 30" or 36" Models: Install fireplace hood accessory (GA6050 or GA6053 see <u>Accessories</u> , page 43). 18" Model: Noncombustible material OK.
Less than 8"	Noncombustible material must be extended to at least 8". See <u>Between 8" and 12"</u> , above. If you cannot extend material, you must operate heater with flue damper open.

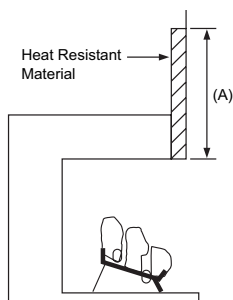

Figure 5 - Heat Resistant Material (Slate, Marble, Tile, etc.) Above Fireplace If Using Mantel

You must have noncombustible material(s) above the fireplace opening. Noncombustible materials (such as slate, marble, tile, etc.) must be at least 1/2" thick. With sheet metal, you must have noncombustible material behind it. Noncombustible material must extend at least 8" up (for all models). If noncombustible material is less than 12", you must install the fireplace hood accessory (24", 30" and 36" Models Only). Even if noncombustible material is more than 12", you may need the hood accessory to deflect heat away from your mantel shelf. See Figures 5 and 6 and Figure 7, page 12, for minimum clearances.

MANTEL CLEARANCES

In addition to meeting noncombustible material clearances, you must also meet required clearances between fireplace opening and mantel shelf. If you do not meet the clearances listed below, you will need a hood.

Determining Minimum Mantel Clearance

If you meet minimum clearance between mantel shelf and top of fireplace opening, a hood is not required (see Figure 6).

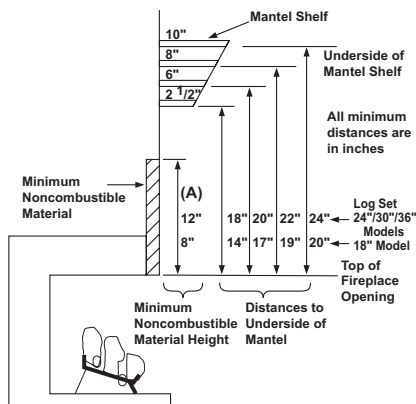

Figure 6 - Minimum Mantel Clearances Without Using Hood

Determining Minimum Mantel Clearance When Using a Hood

If minimum clearances in Figure 6, page 11, are not met, you must have a hood. When using a hood there are still certain minimum mantel clearances required. Follow minimum clearances shown in Figure 7, when using hood.

NOTICE: Surface temperatures of adjacent walls and mantels become hot during operation. Walls and mantels above the firebox may become hot to the touch. If installed properly, these temperatures meet the requirement of the national product standard. Follow all minimum clearances shown in this manual.

INSTALLATION

Continued

NOTICE: If your installation does not meet the minimum clearances shown, you must do one of the following:

- operate the logs only with the flue damper open
- raise the mantel to an acceptable height
- remove the mantel

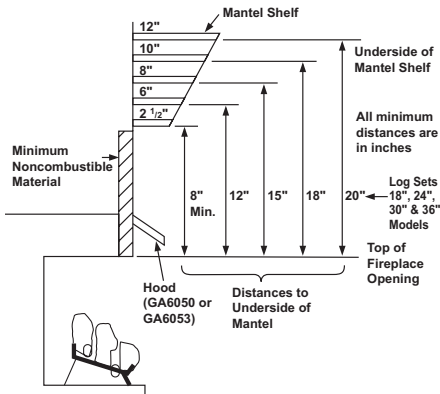

Figure 7 - Minimum Mantel Clearances When Using Hood

FLOOR CLEARANCES

- If installing appliance on the floor level, you must maintain the minimum distance of 14" to combustibles (see Figure 8).
- If combustible materials are less than 14" to the fireplace, you must install appliance at least 5" above the top surface of combustible flooring including tile and carpet (see Figure 9).

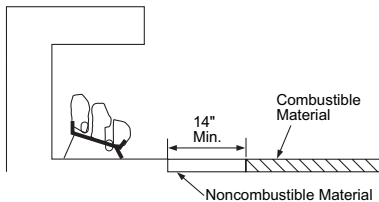

Figure 8 - Minimum Fireplace Clearances If Installed at Floor Level

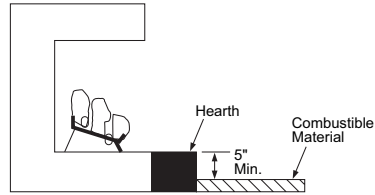

Figure 9 - Minimum Fireplace Clearances Above Combustible Flooring

INSTALLING HEATER BASE ASSEMBLY

WARNING: You must secure this heater to fireplace floor. If not, heater will move when you adjust controls. Moving heater may cause a gas leak.

WARNING: If installing in a sunken fireplace, special care is needed. You must raise the fireplace floor to allow access to heater control panel. This will insure adequate air flow and guard against sooting and controls being damaged. Raise fireplace floor with noncombustible material. Make sure material is secure.

CAUTION: Do not pick up heater base assembly by burners. This could damage heater. Only handle base assembly by grates.

IMPORTANT: Make sure the heater burners are level. If heater is not level, heater will not work properly.

Installation Items Needed

- hardware package (provided with heater)
- approved flexible gas hose and fittings (if allowed by local codes)
- sealant (resistant to propane/LP gas, not provided)
- electric drill with 3/16" masonry drill bit

INSTALLATION

Continued

1. Apply pipe joint sealant lightly to male threads of gas fitting (provided). Connect approved flexible gas hose to inlet side of gas control (see Figure 10).
IMPORTANT: Hold gas regulator with wrench when connecting flexible gas hose.
2. Position heater base assembly in fireplace.
3. Mark screw locations through holes in front panel of base (see Figure 11). If installing in a brick-bottom fireplace, mark screw locations in mortar joint of bricks.
4. Remove heater base from fireplace.
5. Drill holes at marked locations using 3/16" drill bit.
6. Attach base, through holes in front panel of base, to fireplace floor using masonry screws provided in hardware package (see Figure 11).
7. Connect to gas supply. See [Connecting To Gas Supply](#).

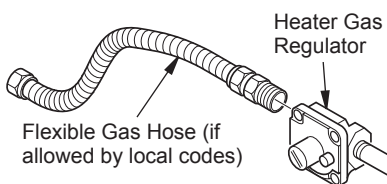

Figure 10 - Attaching Flexible Gas Hose to Heater Gas Regulator

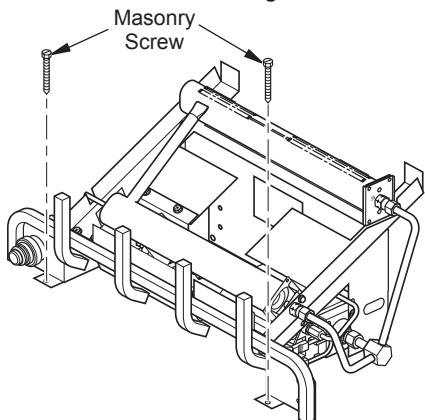

Figure 11 - Attaching Base to Fireplace Floor

CONNECTING TO GAS SUPPLY

⚠ WARNING: This appliance requires a 1/2" NPT (National Pipe Thread) inlet connection to the pressure regulator.

⚠ WARNING: A qualified service person must connect heater to gas supply. Follow all local codes.

⚠ CAUTION: Never connect propane/LP fireplace directly to the propane/LP supply. This heater requires an external regulator (not supplied). Install the external regulator between the heater and propane/LP supply.

⚠ WARNING: Never connect natural gas fireplace to private (non-utility) gas wells. This gas is commonly known as wellhead gas.

Installation Items Needed

Before installing heater, make sure you have the items listed below.

- external regulator (supplied by installer)
- piping (check local codes)
- sealant (resistant to propane/LP gas)
- equipment shutoff valve *
- test gauge connection *
- sediment trap
- tee joint
- pipe wrench
- approved flexible gas line with gas connector (if allowed by local codes)

*An equipment shutoff valve with 1/8" NPT tap is an acceptable alternative to test gauge connection. Purchase the optional equipment shutoff valve from your dealer.

INSTALLATION

Continued

For propane/LP units, the installer must supply an external regulator. The external regulator will reduce incoming gas pressure. You must reduce incoming gas pressure to between 11" and 14" of water. If you do not reduce incoming gas pressure, heater regulator damage could occur. Install external regulator with the vent pointing down as shown in Figure 12. Pointing the vent down protects it from freezing rain or sleet.

CAUTION: Use only new, black iron or steel pipe. Internally-tinned copper tubing may be used in certain areas. Check your local codes. Use pipe of 1/2" diameter or greater to allow proper gas volume to heater. If pipe is too small, undue loss of volume will occur.

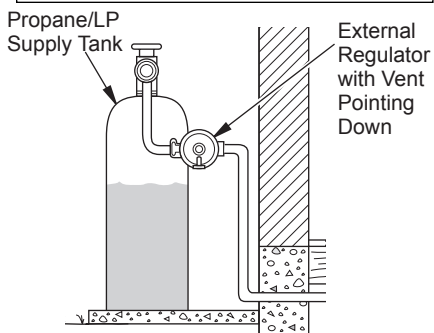

Figure 12 - External Regulator With Vent Pointing Down

Installation must include an equipment shutoff valve, union and plugged 1/8" NPT tap. Locate NPT tap within reach for test gauge hook up. NPT tap must be upstream from heater (see Figure 13).

IMPORTANT: Install equipment shutoff valve in an accessible location. The equipment shutoff valve is for turning on or shutting off the gas to the appliance.

Check your building codes for any special requirements for locating equipment shutoff valve to fireplaces.

Apply pipe joint sealant lightly to male NPT threads. This will prevent excess sealant from going into pipe. Excess sealant in pipe could result in clogged heater valves.

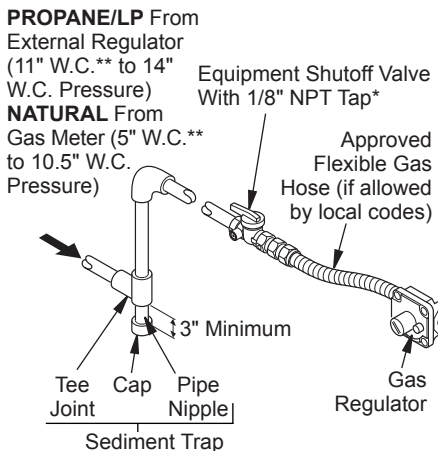

Figure 13 - Gas Connection

* Purchase the optional equipment shutoff valve from your dealer.

**Minimum inlet pressure for purpose of input adjustment.

WARNING: Use pipe joint sealant that is resistant to liquid petroleum (LP) gas.

We recommend that you install a sediment trap in supply line as shown in Figure 13. Locate sediment trap where it is within reach for cleaning. Install in piping system between fuel supply and heater. Locate sediment trap where trapped matter is not likely to freeze. A sediment trap traps moisture and contaminants. This keeps them from going into heater controls. If sediment trap is not installed or is installed wrong, heater may not run properly.

CAUTION: Avoid damage to gas control. Hold gas control with wrench when connecting it to gas piping and/or fittings.

INSTALLATION

Continued

CHECKING GAS CONNECTIONS

WARNING: Test all gas piping and connections, internal and external to unit, for leaks after installing or servicing. Correct all leaks at once.

WARNING: Never use an open flame to check for a leak. Apply a noncorrosive leak detection fluid to all joints. Bubbles forming show a leak. Correct all leaks at once.

CAUTION: Make sure external regulator has been installed between propane/LP supply and heater. See guidelines under Connecting to Gas Supply, page 13.

PRESSURE TESTING GAS SUPPLY PIPING SYSTEM

Test Pressures In Excess Of 1/2 PSIG (3.5 kPa)

1. Disconnect appliance with its appliance main gas valve (control valve) and equipment shutoff valve from gas supply piping system. Pressures in excess of 1/2 psig (3.5 kPa) will damage heater regulator.
2. Cap off open end of gas pipe where equipment shutoff valve was connected.
3. Pressurize supply piping system by either opening propane/LP supply tank valve for propane/LP gas or opening main gas valve located on or near gas meter for natural gas or using compressed air.
4. Check all joints of gas supply piping system. Apply noncorrosive leak detection fluid to all joints. Bubbles forming show a leak.
5. Correct all leaks at once.
6. Reconnect heater and equipment shutoff valve to gas supply. Check reconnected fittings for leaks.

Test Pressures Equal To or Less Than 1/2 PSIG (3.5 kPa)

1. Close equipment shutoff valve (see Figure 14).
2. Pressurize supply piping system by either opening propane/LP supply tank valve for propane/LP gas or opening main gas valve located on or near gas meter for natural gas or using compressed air.
3. Check all joints from gas meter to equipment shutoff valve for natural gas or propane/LP supply to equipment shutoff valve for propane/LP (see Figure 15 or 16). Apply noncorrosive leak detection fluid to all joints. Bubbles forming show a leak.
4. Correct all leaks at once.

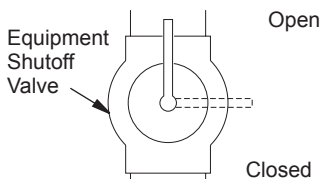

Figure 14 - Equipment Shutoff Valve

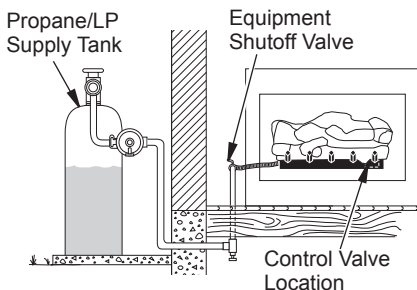

Figure 15 - Checking Gas Joints (Propane/LP Only)

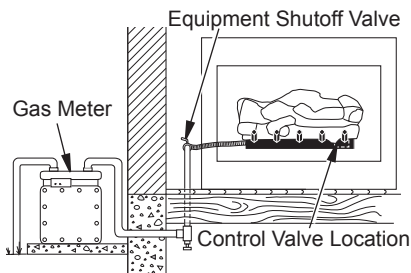

Figure 16 - Checking Gas Joints (Natural Gas Only)

INSTALLATION

Continued

PRESSURE TESTING HEATER GAS CONNECTIONS

1. Open equipment shutoff valve (see Figure 14, page 15).
2. Open main gas valve located on or near gas meter for natural gas or open propane/LP supply tank valve.
3. Make sure control knob of heater is in the OFF position.
4. Check all joints from equipment shutoff valve to gas valve (see Figure 15 or 16, page 15). Apply noncorrosive leak detection fluid to all joints. Bubbles forming show a leak.
5. Correct all leaks at once.
6. Light heater (see *Operation*, page 26 depending on your model). Check all other internal joints for leaks.
7. Turn off heater (see *To Turn Off Gas to Appliance*, page 26).

POWER SUPPLY AND BATTERY INSTALLATION

It is helpful to have a flashlight so you can see the connections as described below. Locate the battery power supply. It is the black box with the red and black wires. Locate the control module (see Figure 17). Connect the battery power supply to the control module by plugging the battery power supply to the mating receptacle on the control module. The receptacle is located on the side of the black control module next to the word "SUPPLY" which is molded in the control module's black housing (see Figure 17). Be certain to push the plug fully into the receptacle. Install batteries in the battery power supply and hand held remote control.

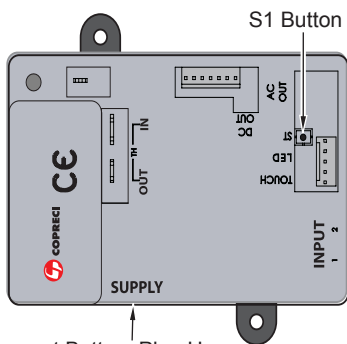

Figure 17 - Control Module

TOUCH PAD INSTALLATION

Locate the touch pad wire harness and the touch pad control (see Figure 18). They are shipped from the factory in the clear plastic bag with your owner's manual. Connect the black plastic connectors together as shown in Figure 19. Connect the remaining end with the white plastic connector to the control module in the socket marked TOUCH LED (see Figure 20).

NOTE: The touch pad includes a red LED display light. If the LED remains on, the black plug is connected upside down. You must unplug the touch pad control from the touch pad wire harness, turn over, and reconnect.

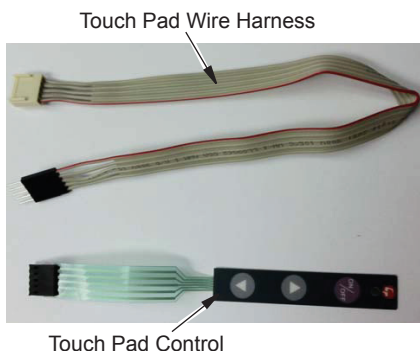

Figure 18 - Touch Pad Wire Harness and Touch Pad Control

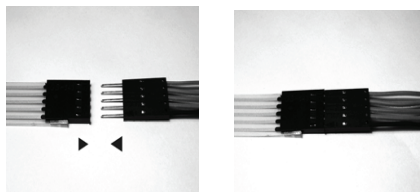

Figure 19 - Touch Pad Control Cable



Figure 20 - Connecting end of Touch Pad Cable

INSTALLATION

Continued

INSTALLING LOGS

⚠ WARNING: Failure to position the parts in accordance with these diagrams or failure to use only parts specifically approved with this heater may result in property damage or personal injury.

Log Support Brackets

If installing a LBG36-SM, attach log support brackets before installing logs. These brackets are provided with the BGE2436 series burner systems.

1. Install left bracket to left side of chassis using 2 screws provided (see Figure 22).
2. Install right bracket to right front of chassis using 2 screws provided (see Figure 22). This bracket will also be used as remote control bracket if remote is installed.

BGE Series Burner System - Log Compatibility Chart		
Burner System Models	Fiber Log Models	Concrete Log Models
BGE18NE BGE18PE	LBG18-SM	LBG18-BM
BGE2436NE BGE2436PE	LBG24-SM LBG30-SM LBG36-SM	LBG24-BM LBG30-BM

Figure 21 - BGE Series Burner System-Log Compatibility Chart

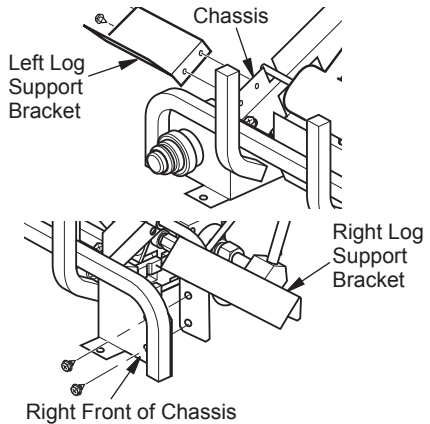

Figure 22- Installing Log Support Brackets

INSTALLATION

Continued

FIBER LOG MODELS

LBG(18,24,30,36)-SM

Note: Your appliance may vary from model shown but log placement will be the same.

1. Place bottom log in center of the base assembly as shown in Figure 23. The log must sit flat on the black sheet metal and behind the left metal tab as shown in Figure 23-a.
2. Rest rear log in back corner sections of base assembly as shown in Figure 23. Make sure log is completely vertical and not leaning in toward burner where flame will touch the log.
3. Position front right log against right side of grate prongs (see Figure 23).
4. Position front left log against left side of grate prongs (see Figure 23).

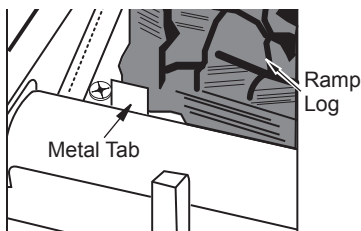

Figure 23-a - Installing Log Set

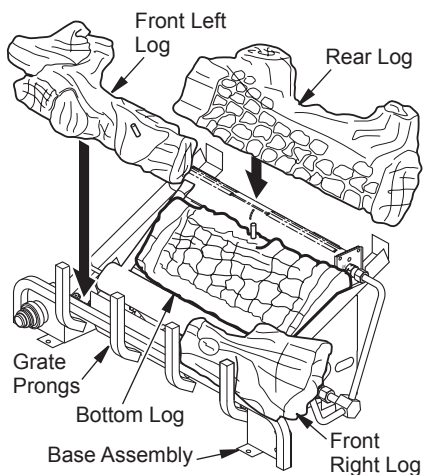

Figure 23 - Installing Log Set

5. Place middle right log over front right and bottom logs as shown in Figure 24. Be sure hole in middle right log seats over pin in bottom log.
6. Place middle left log over front left and bottom logs as show in Figure 24. Be sure hole in middle left log seats over pin in front left log.
7. For LTF36-SM, the front right and left logs are longer and are supported with brackets on each end (see Figure 25). Place left and right small front logs under left bracket and beside right bracket.
8. For LBG36-SM, position left and right control cover logs as shown in Figure 26. These may be placed as desired to hide controls.

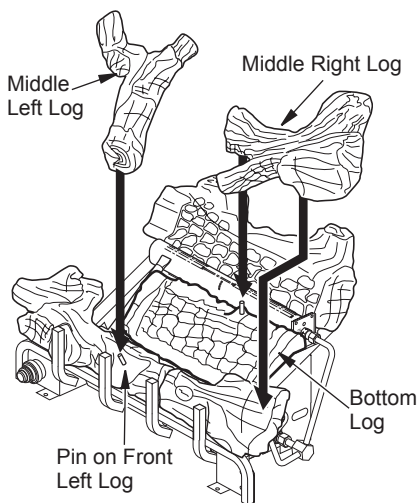

Figure 24 - Installing Log Sets

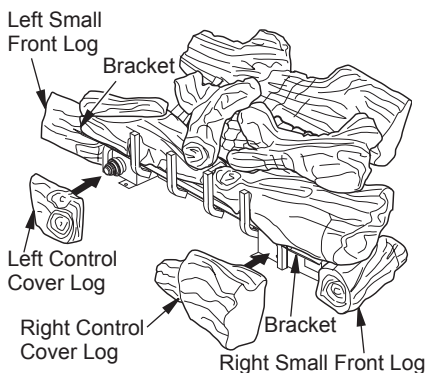

Figure 25 - Installing LBG36-SM Model Control Cover Logs

INSTALLATION

Continued



LBG(18,24,30)-SM MODELS



LBG36-SM MODELS

Figure 26 - Correct Log Placement

CONCRETE LOG MODELS

LBG(18,24,30)-BM

Note: Your appliance may vary from model shown but log placement will be the same.

1. Place fiber ramp log in center of chassis as shown in Figure 27. The fiber ramp log can be identified by the shape and much lighter weight when compared to the other logs. The log must sit flat on the black sheet metal and behind the left metal tab as shown. Make sure the side marked "BOTTOM" is setting down.

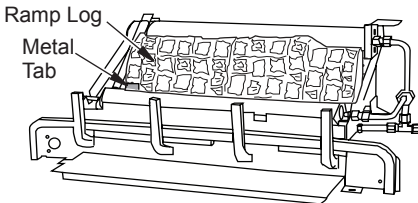

Figure 27 - Installing Fiber Ramp Log

2. Place front left and front right logs as shown in Figure 28.
3. Place left ember bed log as shown in Figure 29. The log has groove on one side that sets on the ember bed pan. The back side of this log needs to rest against the

front of the base assembly. Make sure the flame from the ember pan does not touch the ember bed log.

4. The right ember bed log has a hole in the bottom that sets on the grate finger and the other end rest on the fireplace floor, place log as shown in Figure 30, page 20. The back side of this log needs to rest against the front of the base assembly, make sure the flame from the ember pan does not touch the ember bed log.

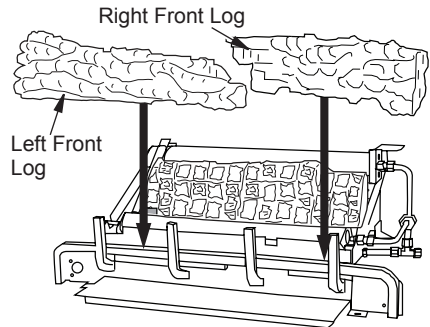

Figure 28 - Installing Left/Right Front Logs

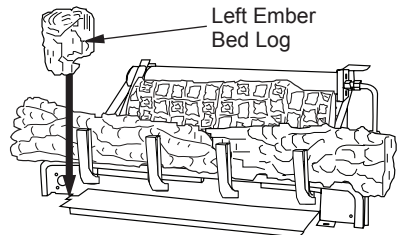

Figure 29 - Installing Left Ember Bed Log

5. The left middle log has a groove on the bottom to sit on the chassis and has to sit on the tab on the back of the left front log as shown in Figure 31.

INSTALLATION

Continued

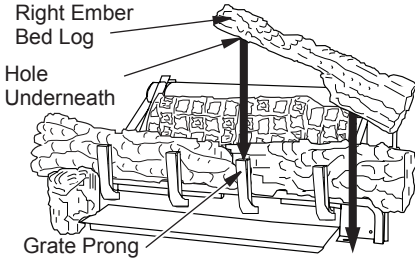

Figure 30 - Installing Right Ember Bed Log

6. The right middle log has a groove on the bottom to sit on the chassis and has to sit on the tab on the back of the right front. The right middle log should have a recess area

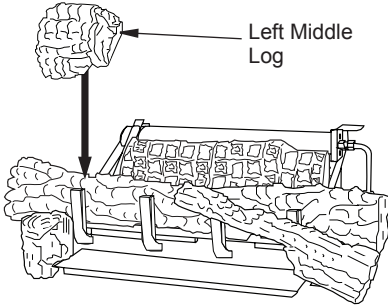

Figure 31 - Installing Left Middle Log

that fits around the ramp log as shown in Figure 32.

7. The rear middle log should fit between the ramp log and the rear burner. The left and right middle logs have recessed areas for the rear middle log to sit into (See Figure

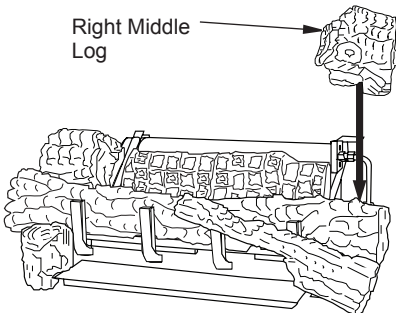

Figure 32 - Installing Right Middle Log

- 33). Be careful not to push the rear burner out of position while installing this log.
8. Rest rear log in back corner sections of chassis assembly as shown in Figure 34.
9. Place the left top log onto the rear log and the left middle log. Make sure to place the projection on the bottom of the left top log into the recessed areas on the rear and left middle logs (see Figure 35).
10. Rest the middle crossover log onto the right middle log and the left front log (see Figure 36). Make sure to match the projection on the bottom of the crossover log with the recess area in the right middle log and the left front log.
11. Place the top rear log onto the rear log as shown. The rear log has a projection that will fit into the recess area on the bottom of the top rear log (see Figure 37).

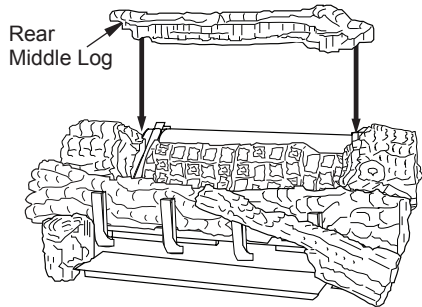

Figure 33 - Installing Rear Middle Log

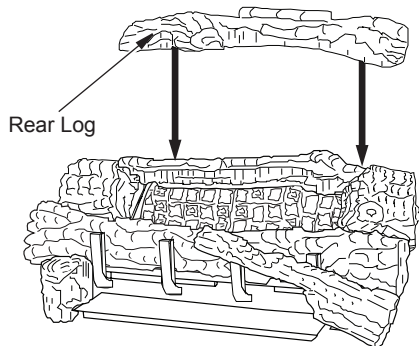

Figure 34 - Installing Rear Log

INSTALLATION

Continued

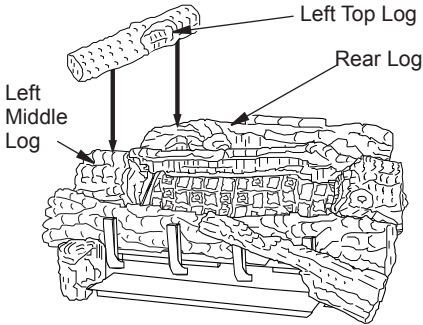

Figure 35 - Installing Left Top Log

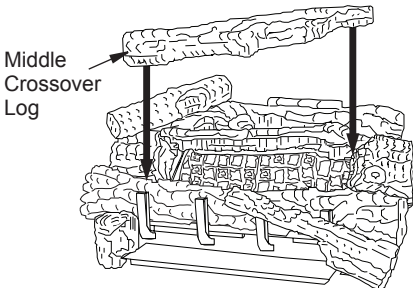

Figure 36 - Installing Middle Crossover Log

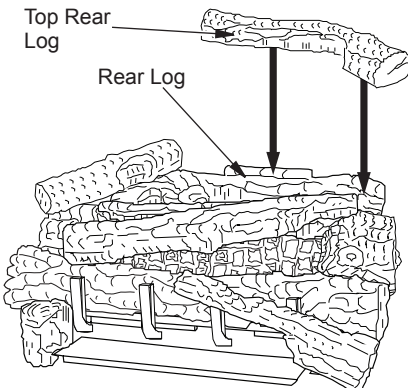

Figure 37 - Installing Top Rear Log

EMBER PLACEMENT

⚠ WARNING: Do not use any other ember material not supplied with this unit.

⚠ WARNING: Do not operate unit without ember material correctly in place as shown in Figures 38 & 39. Do NOT place ember material anywhere else on the unit. Use only ember material supplied with unit. Excessive or incorrectly placed ember material may produce carbon monoxide or soot. If replacement embers are needed, the replacement embers must be purchased from IHP. See page 41 for part numbers.

1. **Ember Chunk Placement.** The BGE2436 burner systems include three ember chunks that are designed to fit over shoulder screws on the ember pan burner. The bottom of each ember chunk has a hole for securing the ember chunk in place when it is placed over a shoulder screw. Place the ember chunks as shown in Figure 38 on page 25 by placing the ember chunk with the number "1" on the left, "2" in the center, and "3" on the right. These numbers are embossed on the back of each piece for identification purposes. Please note that BGE18 burner systems do not include ember chunks.
2. Two ember materials are supplied with this log set. Platinum Bright Embers give a bright glow appearing as hot coals. Should embers need replacing, see *Parts*, page 41.

INSTALLATION

Continued

Platinum Bright Ember placement. Add embers to front, flat burner. Gently remove embers from bag. Separate pieces of ember material and place on surface of flat burner just behind horizontal ports as shown in Figure 54.

Rock Wool placement. Place rock wool material on front flat burner in areas away from ports as shown in Figure 55.

3. Add lava rock and small decorative logs around base of heater if desired. **DO NOT place rock or additional logs on front burner or on logs.** Placing any material

on unit other than ember material on front burner may result in production of carbon monoxide or soot. Use lava rock to hide wires from switch/log to control valve. Place switch/log so the switch is easy to access.

⚠ WARNING: All previously applied loose material must be removed prior to reapplication.

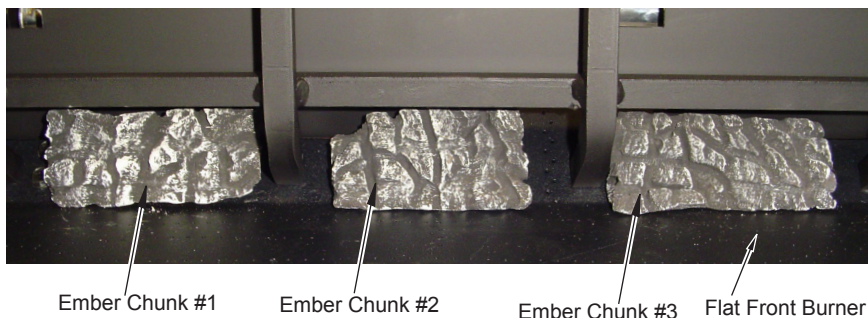

Figure 38 - Ember Chunk Placement SVFS36 Series



Figure 39 - Platinum Bright Embers



Figure 40 - Placement of Rock Wool (shown with Platinum Bright Embers)

OPERATION

NOTICE: During initial operation of new heater, burning logs will give off a paper-burning smell. Orange flame will also be present. Open damper or window to vent smell. This will only last a few hours.

WARNING:

- If fireplace has glass doors, never operate this heater with glass doors closed. If you operate heater with doors closed, heat buildup inside fireplace will cause glass to burst. Make sure there are no obstructions across openings of fireplace.
- You must operate this heater with a fireplace screen in place. Make sure fireplace screen is closed before running heater.

 **WARNING:** Damper handle will be hot if heater has been running.

 **CAUTION:** Do not try to adjust heating levels by using the equipment shutoff valve.

**FOR YOUR SAFETY
READ BEFORE LIGHTING**

 **WARNING:** If you do not follow these instructions exactly, a fire or explosion may result causing property damage, personal injury or loss of life.

- A. This appliance is equipped with an ignition device which automatically lights the pilot. Do not light pilot by hand.
- B. **BEFORE LIGHTING** smell all around the appliance area for gas. Be sure to smell next to the floor because some gas is heavier than air and will settle on the floor.

WHAT TO DO IF YOU SMELL GAS

- Do not try to light any appliance.
 - Do not touch any electric switch; do not use any phone in your building.
 - Immediately call your gas supplier from a neighbor's phone. Follow the gas supplier's instructions.
 - If you cannot reach your gas supplier, call the fire department.
- C. Do not use this appliance if any part has been under water. Immediately call a qualified service technician to inspect the appliance and to replace any part of the control system and any gas control which has been under water.

LIGHTING INSTRUCTIONS

1. STOP! Read the safety information.
2. Make sure equipment shutoff valve is fully open.
3. Press any button on the remote to power the remote on. Press the MODE zone or the MODE/SET Button to start the unit. You will hear a beep from the control module and the pilot will start to light the unit.

Note: You may be running this heater for the first time after hooking up to gas supply. If so, you may have to restart the unit several of times to allow the air to bleed from the system.

TO TURN OFF GAS TO APPLIANCE

1. Once you have activated the screen press the MODE Zone or MODE/SET Button until you see OFF.
2. Close equipment shutoff valve.

OPERATION

Continued

REMOTE CONTROL OPERATION

BASIC CONSTRUCTION

- Touch-Screen LCD and three push buttons will allow input from users.
- LCD screen will provide system status & input feedback to user.
- Backlight will illuminate LCD screen for 5 seconds after any user input – the 1st touch of the LCD screen will only illuminate the backlight (will not respond to associated zone function). To activate any command, the backlight for the screen must be on and the command must be touched before the backlight goes off.
- Powered via four AAA sized batteries (6V nominal) with LOW BATTERY INDICATOR (5.0V).

Touch-Screen LCD and Button Layout (Not to scale)

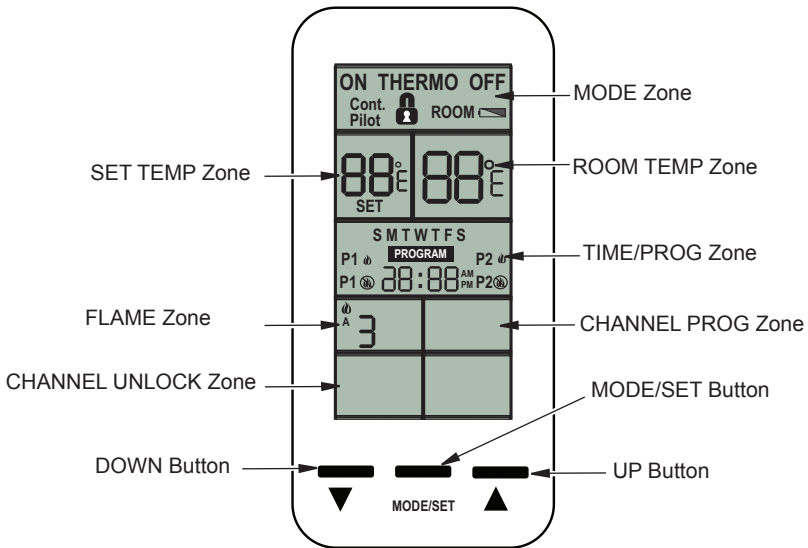

Figure 41 - Touch-Screen LCD and Button Layout

OPERATION

Continued

FUNCTIONAL DESCRIPTION

Note: All function adjustments will be automatically accepted 15-seconds after pressing a given touch zone or button. The user may press the MODE/SET button to immediately accept the adjustment manually.

CHANNEL SELECTION

This control may be operated in 3 different sub-channels for applications where 2.4GHz interference causes delayed operation of the remote control. The factory default is Channel 3. To change the channel on the transmitter:

- Touch the CHANNEL PROGRAM and CHANNEL UNLOCK zones simultaneously and hold for 5-seconds.
- The LCD screen will go blank except "Ch" will be displayed in the SET TEMP Zone and either "01", "02", or "03" will be displayed in the ROOM TEMP Zone.
- Press the UP or DOWN buttons to change the channel number (01-03).
- Press the MODE/SET Button to return to the normal operating display.

Receiver Operation Notes:

- The receiver manufacturer may refer to channels 01, 02, or 03.
- Receiver must be paired with transmitter in the receiver's factory default channel.
- Once paired, the channel selection may be changed in the transmitter per the instructions above.
- Once the channel selection is changed in the transmitter, the power supply to the receiver must be removed for at least 30-seconds, then re-applied.
- The receiver will recognize the new channel selection after about 30-seconds to 1-minute and normal operation will resume.

MODES OF OPERATION

OPERATION MODES:

- MANUAL OFF
- MANUAL ON
- THERMOSTAT (with optional PROGRAM Mode)

The modes may be cycled in the order above by touching the MODE Zone or pressing the MODE/SET Button.

MANUAL OFF MODE:

- Transmits flame OFF command.
- Pilot Method: Intermittent Pilot Ignition (IPI)/Spark-to-Pilot only (continuous/standing pilot not allowed)
 - Pilot flame will be turned OFF
- **LCD Displays:**
 - MODE Zone: OFF is displayed
 - ROOM TEMP Zone: Measured temperature is displayed
 - SET TEMP Zone: Blank
 - TIME/PROG Zone: Current day indicator and current time is displayed
 - FLAME Zone: Blank

MANUAL ON MODE:

- Transmits flame ON command.
- Pilot Method: Intermittent Pilot Ignition (IPI)/Spark-to-Pilot only (continuous/standing pilot not allowed)
 - Pilot flame will be ignited before turn Main Flame ON.
- **LCD Displays:**
 - MODE Zone: ON is displayed
 - ROOM TEMP Zone: Measured temperature is displayed
 - SET TEMP Zone: Blank
 - TIME/PROG Zone: Current day indicator and current time is displayed
 - FLAME Zone: A Flame Icon and flame setting level number is displayed

THERMOSTAT MODE:

- Will cycle flame on and off based on room and set temperatures. Will transmit ON command if SET TEMP (+SWING) is higher than ROOM TEMP and will transmit OFF command if SET TEMP (-SWING) is lower than ROOM TEMP.
- Built-in thermostat will measure room temperature.
- All programming should be written for deg. F and converted to deg. C when selected.
- Temperatures may be displayed in degrees F (factory default) or degrees C. Press the UP and DOWN Buttons simultaneously to change between degrees F and C.
- SET TEMP: While in THERMOSTAT mode, press the UP or DOWN Button

OPERATION

Continued

to change the SET TEMP (45-90 deg. F, 7-32 deg. C); the new set temperature will automatically be accepted after 2 seconds. The factory default SET TEMP is 68 deg. F.

- SWING Temperature: This model does not allow for SWING temperature adjustment. This model utilizes thermostatic flame modulation that will modulation the main flame based on the difference between room temperature and set temperature (see example below).
- Important - factory SWING TEMPERATURE setting is 2 degrees. The thermostatic flame modulation feature will not allow this SWING to be changed.

EXAMPLE:

<u>Set Temperature</u>	<u>Room Temp.</u>	<u>Flame Level</u>
	74F	OFF
	73F	Level 1
Set Temperature (72) →	72F	Level 2
	71F (or less)	Level 3

- Pilot Method: Continuous/Standing Pilot only (Intermittent Pilot Ignition (IPI)/ Spark-to-Pilot not allowed).
- Pilot flame will remain ON when Main Flame Cycles ON and OFF.
- Manual Flame Adjustment while in THERMOSTAT mode: If Flame-A is manually adjusted while in thermostat mode, it will override the automatic flame setting until the flame cycles off, then back ON thermostatically; when the flame cycles ON again, automatic flame adjustment will resume. Automatic flame adjustment will also resume if the operational mode is cycled out of, then back into THERMOSTAT mode or if the SET temperature is changed.
- THERMOSTAT OFF LCD Displays:
 - MODE Zone: THERMO and OFF is displayed
 - ROOM TEMP Zone: Measured temperature is displayed
 - SET TEMP Zone: SET TEMP is displayed
 - TIME/PROG Zone: Current day indicator and current time is displayed
 - FLAME Zone: Blank
- THERMOSTAT ON LCD Displays:

- MODE Zone: THERMO and ON are displayed
- ROOM TEMP Zone: Measured temperature is displayed
- SET TEMP Zone: SET TEMP is displayed
- TIME/PROG Zone: Current day indicator and current time is displayed
- FLAME Zone: A Flame Icon and flame setting level number is displayed

Thermostat Disable Feature

- The Thermostat Mode (described above) may be disabled for applications where a thermostat is not allowed or undesirable. When Thermostat Mode is Disabled:
 - The Modes of operation will cycle between MANUAL ON and MANUAL OFF (omitting THERMO).
 - Program Operation (described below) is also disabled.
 - The SET TEMP zone will be blank.
 - The room temperature will still be measured & displayed in the ROOM TEMP Zone.
 - The TIME/PROG zone will continue to display the Clock and Day of week, but none of the icons associated with Program Mode will be displayed.
- To disable or re-enable the Thermostat, the transmitter must be in MANUAL OFF Mode, then touch and hold the SET TEMP Zone and the DOWN Button simultaneously for 10- seconds. The LCD screen will go blank except either THERMO and OFF or THERMO and ON will flash 3-times (0.5-seconds OFF, 0.5-seconds ON) to indicate the change has been made.

DAY AND TIME DISPLAY

- The current day of week and time of day will be continuously displayed in the TIME/PROG Zone (except during Setup operations).
- The day of week will be displayed as one of the following: S, M, T, W, T, F, S
- The time of day will be in 12-hour AM, 12-hour PM format. Midnight will be displayed as 12:00am.
- Day/Time Setup:
 1. Press and hold the MODE Zone for 5 seconds to enter Day/Time Setup.

OPERATION

Continued

2. Touch the UP or DOWN Buttons to adjust the day of week (press the MODE/SET Button or wait for 15 seconds for adjustment to be accepted, then enter hour of day adjustment).
 3. Press the UP or DOWN Buttons to adjust the hour of the day. The time will advance in 1-hour increments; AM and PM will change when the hour advances to 12:00 midnight and 12:00 noon respectively (press the MODE/SET Button or wait for 15 seconds for adjustment to be accepted, then enter minute of hour adjustment).
 4. Press the UP or DOWN Buttons to adjust the minute of the hour. The time will advance in 1-minute increments (press the MODE/SET Button or wait for 15 seconds and the transmitter will exit Day/Time Setup and return to normal operation).
 5. LCD Displays – when in Day/Time Setup:
 - MODE Zone: Blank
 - ROOM TEMP Zone: Blank
 - SET TEMP Zone: Blank
 - TIME/PROG Zone: Day of Week, or Time of Day will Flash
 - FLAME Zone: Blank
- To enter Program Setup, touch and hold the TIME/PROG Zone for 5 seconds.
 - Program OFF LCD Displays:
 - MODE Zone: OFF
 - ROOM TEMP Zone: Measured temperature is displayed
 - SET TEMP Zone: Blank
 - TIME/PROG Zone: Current day indicator, current time, and Program status (P1- OFF or P2-OFF) is displayed
 - FLAME Zone: Blank
 - Program ON LCD Displays:
 - MODE Zone: THERMO and either ON or OFF is displayed
 - ROOM TEMP Zone: Measured temperature is displayed
 - SET TEMP Zone: SET TEMP is displayed
 - TIME/PROG Zone: Current day indicator, current time, and Program status (P1- ON or P2-ON) is displayed
 - FLAME Zone:
 - If Thermostat is ON, A Flame Icon and flame setting level number is displayed.
 - If Thermostat is OFF, display is blank.

Program Operation

- Touch the TIME/PROG Zone to activate or deactivate Program Operation. Touching the MODE Zone or pressing the MODE/SET Button will also deactivate Program Operation. When Program Operation is deactivated, the transmitter will return to MANUAL OFF Mode.
 - Program Operation will cycle fireplace ignition ON and OFF based on time settings (2 weekend periods and 2 weekday periods) and thermostat settings. Press the MODE/SET Button or wait for 15 seconds to advance to each subsequent program setting.
 - **Pilot Method (same as Thermostat Mode): Continuous/Standing Pilot only (Intermittent Pilot Ignition (IPI)/ Spark-to-Pilot not allowed).**
 - Pilot flame will remain ON when Main Flame Cycles ON and OFF.
- The Program Mode (described above) may be disabled for applications where a program operation is not allowed or undesirable. When Program Mode is Disabled:
 - The user will not be able to activate Program Mode
 - The user will not be able to enter Program Setup or edit Program Mode settings.
 - The TIME/PROG zone will continue to display the Clock and Day of week, but none of the icons associated with Program Mode will be displayed.
 - To disable or re-enable the Program Mode, the transmitter must be in MANUAL OFF Mode, then touch and hold the TIME/PROG Zone and the DOWN Button simultaneously for 10-seconds. The LCD screen will go blank except either PROGRAM and OFF (OFF display in MODE Zone) or PROGRAM and ON (ON display in MODE Zone) will flash 3-times (0.5-seconds OFF, 0.5-seconds

OPERATION

Continued

ON) to indicate the change has been made.

Flame-A (or Main) Adjustment

- Transmits a flame height setting command to the control module to adjust the Flame-A height.
- Available settings are 1-3 with a factory default of 3. Refer to the THERMOSTAT Mode section for additional details on flame modulation in THERMOSTAT mode.
- While in MANUAL ON, THERMOSTAT ON, or PROGRAM ON modes, touch the FLAME Zone to enter Flame-A Adjustment, then press the UP or DOWN buttons to raise and lower the flame; press the MODE/SET Button or wait for 15 seconds to accept the new setting.
- LCD Display: When setting the Flame-A height, the Flame-A icon, and Flame-A setting number will flash in the FLAME Zone.

Child-Lock Operation

- Child-Lock operation prevents any user input to the transmitter. No mode of operation or feature may be adjusted when Child-Lock is activated. All automatic functions (thermostat, program, etc.) will continue normally.
- To activate or deactivate the Child-Lock feature, press and hold the MODE/SET and DOWN Buttons simultaneously for 5 seconds.
- LCD Displays:
 - When activated, the LOCK icon will appear in the MODE Zone.
 - If any touch-zone or button is pressed when activated, the LCD backlight will illuminate and the LOCK icon will flash for 5 seconds in the MODE Zone.

Room Temperature Limit

- The Room Temperature Limit Shutdown feature will operate in MANUAL ON, THERMOSTAT ON mode, and PROGRAM ON modes. If the room temperature reaches 95 deg. F or greater, the transmitter will automatically change to MANUAL OFF mode and send a MANUAL OFF command to the control module. If the user turns the control back ON and the room temperature is

still 95F or greater, the transmitter will switch to back manual OFF and send another OFF command the next time the transmitter reads & updates the room temperature (2-minute update interval).

PAIRING

The remote and receiver are paired at the factory but in case they do not communicate after proving the batteries are fresh, repairing may be necessary. Follow the steps below to repair the remote to the receiver.

It is helpful to have a flashlight so you can see the connections as described below. Before proceeding, locate the S1 button on the receiver shown in the figure below. You will need to access this button during the re-pairing procedure and only have 20 seconds to press and release it.

To enter pairing mode press and hold the MODE/SET Button for 10-seconds.

- Transmitter will transmit a pairing signal for 20-seconds, then automatically exit pairing mode and return to normal operation.
- LCD Displays – When pairing mode is activated:
 1. MODE Zone: Blank
 2. ROOM TEMP Zone: The letters “On” will flash.
 3. SET TEMP Zone: The letter “P” is displayed
 4. TIME/PROG Zone: Blank
 5. FLAME Zone: Blank

Receiver Operation Note: Once transmitter is in pairing mode, press the yellow or black pairing button on the receiver.

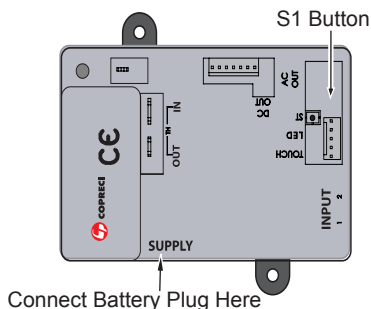

Control Module

OPERATION

Continued

TOUCH PAD OPERATION

This touch control has only 3 buttons for controlling manually the flame of the appliance (see Figure 43).

The touch pad has:

1. Led display
2. ON/OFF button
3. UP button
4. DOWN button

With this control it is possible to turn on the fire, turn off the fire and control the flame level.

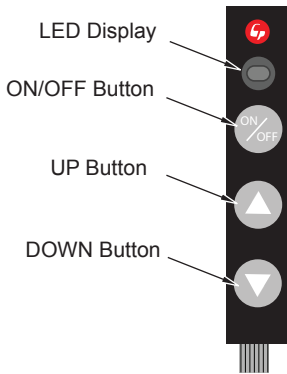

Figure 42 - Touch Pad Control

Note: The touch pad includes a red LED display light. If the LED remains on, the black plug is connected upside down. Unplug, turn over, and reconnect.

SWITCHING ON

To turn the system on just press the ON/OFF button. The system will emit a beep and begin the ignition process, which can take about 20 seconds. Once the start up process is complete, the pilot flame is lit.

REGULATING THE FLAME LEVEL.

1. To increase the flame level, press the up button (▲). A beep and a flash of the LED indicate that the system has accepted the order, and the flame will increase instantly (see Figure 59).
2. To decrease the flame level, press the down button (▼). A beep and a flash of the LED indicate that the system has accepted the order, and the flame will decrease instantly (see Figure 59).

SWITCHING OFF

To switch off the fire, the ON/OFF button should be pressed. After the system has emitted a beep, the fire switches off.

! WARNING: Do not convert heater to use different fuel type. Only use heater with fuel type specified.

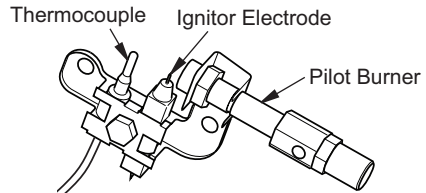

Figure 43 - Pilot (Natural)

INSPECTING BURNERS

Check pilot flame pattern and burner flame patterns often.

PILOT FLAME PATTERN

Figure 44, page 33 shows a correct pilot flame pattern. Figure 45, page 33 shows an incorrect pilot flame pattern. The incorrect pilot flame is not touching the thermocouple. This will cause the thermocouple to cool. When the thermocouple cools, the heater will shut down. If pilot flame pattern is incorrect, as shown in Figure 45, page 30.

- turn heater off (see [To Turn Off Gas to Appliance](#), page 26)
- see [Troubleshooting](#), page 36

Note: The pilot flame on natural gas units will have a slight curve, but flame should be blue and have no yellow or orange color.

INSPECTING BURNERS

Continued

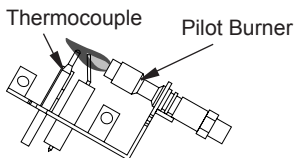

Figure 44 - Correct Pilot Flame Pattern
(Your pilot may vary from pilots shown)

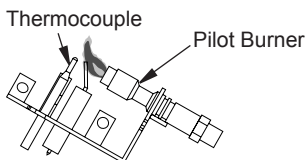

Figure 45 - Incorrect Pilot Flame Pattern
(Your pilot may vary from pilots shown)

BURNER FLAME PATTERN

Figure 46, shows correct burner flame pattern. Figure 47, shows incorrect burner flame pattern.

WARNING: If incorrect burner flame occurs, your heater could produce increased levels of carbon monoxide.

NOTICE: Do not mistake orange flames with yellow tipping. Dirt or other fine particles are burned by heater, causing brief patches of orange flame.

If burner flame pattern is incorrect, as shown in Figure 47.

- turn heater off (see *To Turn Off Gas to Appliance*, page 23).
- see *Troubleshooting*, page 33

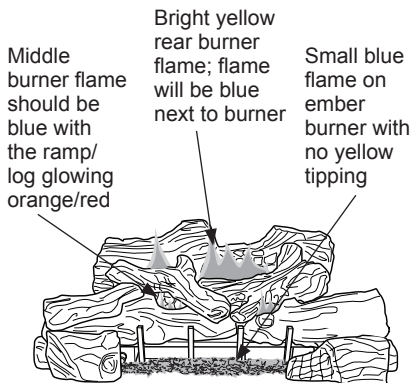

Figure 46 - Correct Burner Flame Pattern

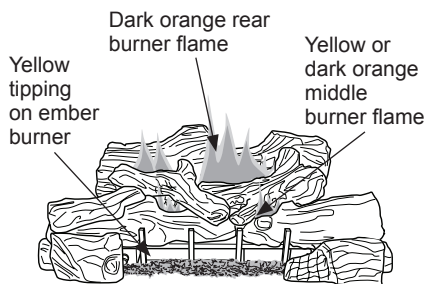

Figure 47 - Incorrect Burner Flame Pattern

CLEANING AND MAINTENANCE

WARNING: Turn off heater and let cool before cleaning.

CAUTION: You must keep control areas, burners and circulating air passageways of heater clean. Inspect these areas of heater before each use. Have heater inspected yearly by a qualified service person. Heater may need more frequent cleaning due to excessive lint from carpeting, pet hair, bedding material, etc.

WARNING: Failure to keep the primary air opening(s) of the burner(s) clean may result in soot-ing and property damage.

CLEANING AND MAINTENANCE

Continued

BURNER ORIFICE HOLDER AND PILOT AIR INLET HOLE

The primary air inlet holes allow the proper amount of air to mix with the gas. This provides a clean burning flame. Keep these holes clear of dust, dirt, lint and pet hair. Clean these air inlet holes prior to each heating season. Blocked air holes will create soot. We recommend that you clean the unit every three months during operation and have heater inspected yearly by a qualified service person.

We also recommend that you keep the burner tube and pilot assembly clean and free of dust and dirt. To clean these parts we recommend using compressed air no greater than 30 PSI. Your local computer store, hardware store or home center may carry compressed air in a can. If using compressed air in a can, please follow the directions on the can. If you don't follow directions on the can, you could damage the pilot assembly.

1. Shut off unit, including pilot. Allow unit to cool for at least thirty minutes.
2. Inspect burner, pilot and primary air inlet holes on orifice holder for dust and dirt (see Figure 48).
3. Blow air through the ports/slots and holes in the burner.

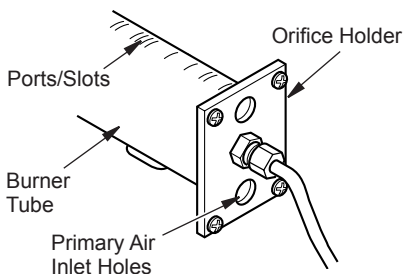

Figure 48 - Orifice Holder On Outlet Burner Tube

4. Check orifice holder located at the end of the burner tube again. Remove any large particles of dust, dirt, lint or pet hair with a soft cloth or vacuum cleaner nozzle.
5. Blow air into the primary air holes on the orifice holder.
6. In case any large clumps of dust have now been pushed into the burner repeat steps 3 and 4.

Clean pilot assembly also. A yellow tip on the pilot flame indicates dust and dirt in the pilot assembly. There is a small pilot air inlet hole about 2" from where the pilot flame comes out of the pilot assembly (see Figure 49). With the unit off, lightly blow air through the air inlet hole. You may blow through a drinking straw if compressed air is not available.

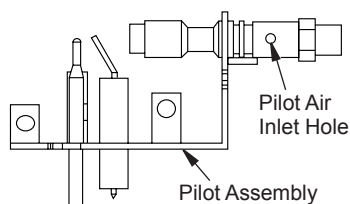

Figure 49 - Pilot Inlet Air Hole (Your pilot may vary from pilot shown)

LOGS

- If you remove logs for cleaning, refer to [Installing Logs](#), page 17, to properly replace logs.
- Replace log(s) if broken or chipped (dime-sized or larger).

MAIN BURNER

Periodically inspect all burner flame holes with the heater running. All slotted burner flame holes should be open with yellow flame present. All round burner flame holes should be open with a small blue flame present. Some burner flame holes may become blocked by debris or rust, with no flame present. If so, turn off heater and let cool. Remove blockage, blocked burner flame holes will create soot.

WIRING DIAGRAM

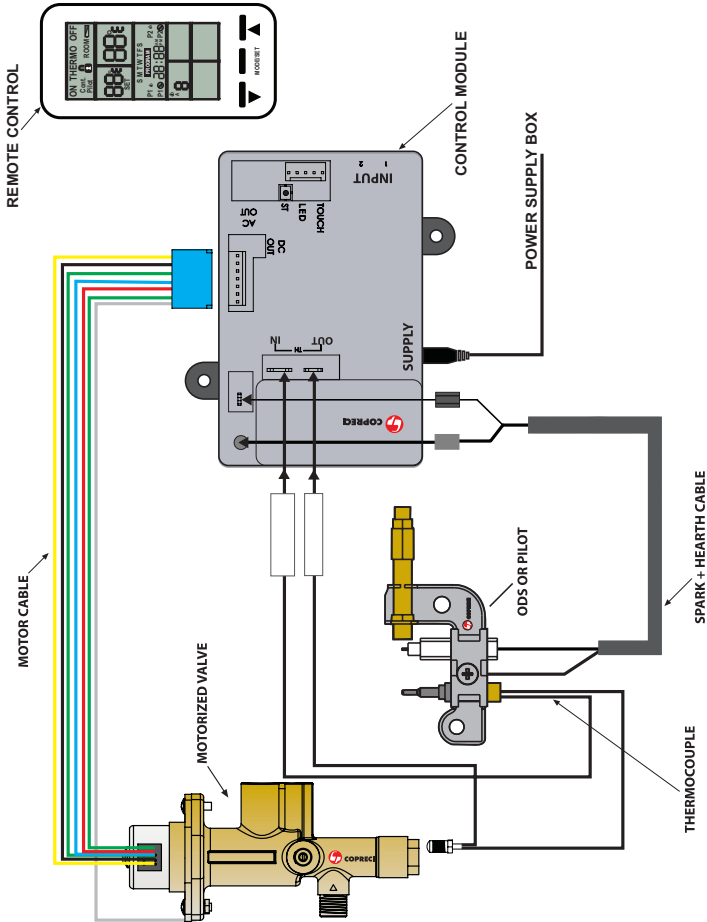

SPECIFICATIONS

BGE18PE

- Rating (Variable): 24,000/30,000 Btu/Hr
- Type Gas: Propane/LP
- Ignition: Electronic
- Manifold Pressure: 8" W.C.
- Inlet Gas Pressure (in. of water):
Max - 14" W.C., Min* - 11" W.C.

BGE18NE

- Rating (Variable): 21,000/30,000 Btu/Hr
- Type Gas: Natural
- Ignition: Electronic
- Manifold Pressure: 4.5" W.C.
- Inlet Gas Pressure (in. of water):
Max - 10.5" W.C., Min* - 5" W.C.

BGE2436PE

- Rating (Variable): 30,000/39,000 Btu/Hr
- Type Gas: Propane/LP
- Ignition: Electronic
- Manifold Pressure: 8" W.C.
- Inlet Gas Pressure (in. of water):
Max - 14" W.C., Min* - 11" W.C.

BGE2436NE

- Rating (Variable): 26,000/39,000 Btu/Hr
- Type Gas: Natural
- Ignition: Electronic
- Manifold Pressure: 4.5" W.C.
- Inlet Gas Pressure (in. of water):
Max - 10.5" W.C., Min* - 5" W.C.

*For purpose of input adjustment

TROUBLESHOOTING

⚠ WARNING: Turn off heater and let cool before servicing. Only a qualified service person should service and repair heater.

⚠ CAUTION: Never use a wire, needle or similar object to clean ODS/pilot. This can damage ODS/pilot unit.

Note: All troubleshooting items are listed in order of operation.

OBSERVED PROBLEM	POSSIBLE CAUSE	REMEDY
<p>Either the remote or touch pad buttons are pressed to start the burner ignition sequence and there is no function or response.</p>	1. Missing or weak batteries at power supply box or remote. Control module may beep 10 times or may not beep at all. LCD display may show "BATTERY ERROR".	1. Check batteries and replace if needed. (Batteries in the power supply box can be tested with a multimeter at the two connections at the back of the battery housing where the red and black wires are connected. Set the multimeter to DC voltage, initiate the ignition sequence, and observe the voltage while the system is lighting (under load). The system will not function under 3.8 volts and batteries should be replaced if the voltage is under 4.0 volts.)
	2. Unplugged power supply (battery) box	2. Plug power supply box to module see page 16.
	3. Touch pad not plugged in to module or plugged in incorrectly	3. Plug touch pad in module see page 16, figure 19. Check to see it is positioned as shown.
	4. Control valve wiring harness not plugged in or not in proper position	4. Check to see that the control valve wiring harness' blue connector is plugged in to the module. Check to see that it is aligned with the mating pins. If any pins are visible, then the connector is not in the correct position. If this is the case, disconnect, align, and reconnect to the module.
	5. Remote not communicating with control module	5. (The remote communicates with the module periodically. It doesn't communicate with the module continuously to conserve battery power.)

TROUBLESHOOTING

Continued

OBSERVED PROBLEM	POSSIBLE CAUSE	REMEDY
Either the remote or touch pad buttons are pressed to start the burner ignition sequence and there is no function or response. (Continued from page 36).	6. LED is blinking	6. This indicates the battery power is low. Replace the batteries in the power supply box.
	7. Ignitor cable is not connected	7. Check the ignitor connection at both the control module and the ods pilot. Connect if loose.
	8. Ignitor cable pinched or wet	8. Free ignitor cable if pinched by any metal or tubing. Keep ignitor cable dry.
	9. Broken Ignitor cable.	9. Replace wire harness including ignitor cable.
	10. Ignitor electrode positioned wrong.	10. Replace ods pilot assembly.
	11. Ignitor electrode broken.	11. Replace ods pilot assembly.
	12. Control module sounds 2 cycles of 3 beeps; LCD display may show ROM ERROR	12. Replace control module
	13. Control module sounds 2 cycles of 5 beeps; LCD display may show SUPPORT ERROR	13. Ground cable from control valve wiring harness is not grounding properly. Reposition spade terminal so that it makes contact with burner chassis metal or valve body.
	14. Bad reception from remote	14. Change batteries in remote. Check reception of signal from a shorter distance. If still not working, try changing the channel in the configuration menu. If this does not fix the problem, reset the channel (see page 28 Channel Selection) and follow the instructions in Pairing on page 28. Replace remote and control module as a final action.
	15. If LED on touch pad is continuously on, the cable is connected the wrong way.	15. Disconnect the touch pad between the long and short cables, turn the short cable with the touch pad over and reconnect.
	16. The control module sounds 2 cycles of 5 beeps. The wiring assembly from the control valve is disconnected or broken.	16. Connect the wiring harness at the control module. Replace the valve assembly if all other cause/remedies fail to correct his problem.

TROUBLESHOOTING

Continued

OBSERVED PROBLEM	POSSIBLE CAUSE	REMEDY
When ignitor button is pressed on the remote or touch pad, the pilot sparks but there is no ignition.	1. Gas supply turned off or equipment shutoff valve closed	1. Turn on gas supply or open equipment shutoff valve.
	2. Air in gas lines.	2. Continue turning the burner system ON and OFF. Repeat igniting operation until air is removed. On first time ignitions, air in the lines is common and it is not uncommon to repeat the ignition sequence 10 to 15 times before enough gas is at the ods pilot for it to light.
	3. Thermocouple circuit between the control valve and the control module is open.	3. Check the thermocouple connection at the control valve and also at the control module. The thermocouple connection at the control valve should be hand tight plus 1/4 to 1/2 turn. You should not be able to loosen the thermocouple at the control valve with your hand. Check the thermocouple terminal connection at the control module. If it is loose, remove it with needle nose pliers, using the pliers, slightly close the terminal's opening and reinstall on to the control module.
	4. No gas to the ods pilot	4. While the pilot is sparking, check for gas flow at the ods pilot. If flow is present, try to light the pilot with a long reach lighter. If it will not light but the flame is disturbed, air is in the line. Cycle through the ignition sequence to clear the line of air until gas is present. If no flow is present at the gas valve, check to see all shut off valves are open. Verify proper pressure is supplied to the valve. Excessive pressure can lock out the appliance's regulator. Also check to see that the wiring harness from the control valve is properly connected at the control module. The wiring harness connection housing can be identified by it's blue connector housing.
	5. Depleted gas supply (propane/LP only)	5. Contact local propane/LP gas company.
	6. Valve cable is disconnected or broken.	6. Connect valve cable correctly
	7. ODS pilot is clogged	7. Clean ods pilot (see Cleaning and Maintenance , page 33) or replace ods pilot assembly.
	8. Gas regulator setting is not correct	8. Replace gas regulator

TROUBLESHOOTING

Continued

OBSERVED PROBLEM	POSSIBLE CAUSE	REMEDY
ODS pilot lights but pilot flame goes out before burners light.	1. Equipment shutoff valve not fully open	1. Fully open equipment shutoff valve.
	2. Missing or weak batteries at power supply box or remote.	2. Check batteries and replace if needed. (Batteries in the power supply box can be tested with a multimeter at the two connections at the back of the battery housing where the red and black wires are connected. Set the multimeter to DC voltage, initiate the ignition sequence, and observe the voltage while the system is lighting (under load). The system will not function under 3.8 volts and batteries should be replaced if the voltage is under 4.0 volts.)
	3. Thermocouple circuit between the ods pilot and control module is loose or damaged.	3. Check thermocouple terminal connection at the control module. If it is loose, remove it with needle nose pliers, using the pliers, slightly close the terminal's opening and reinstall on to the control module.
	4. Pilot flame not touching thermocouple, which allows thermocouple to cool, causing pilot flame to go out. This problem could be caused by one or both of the following: A) Low gas pressure or B) Dirty or partially clogged ODS pilot.	4. A) Contact local natural or propane/LP gas company. B) Clean ODS pilot (see Cleaning and Maintenance , page 34) or replace ODS pilot assembly.
	5. Thermocouple damaged	5. Replace ods pilot assembly.
	6. Control valve damaged.	6. Replace control valve
Burner system lights from remote but not from touch pad	1. Touch pad cable disconnected or broken	1. Connect or replace touch pad and cable.
	2. Defective touch pad	2. Replace touch pad
Burner system does not ignite the burner while the remote is in the program mode.	1. Program mode does not work if soft start is deactivated.	1. Activate soft start in the remote.
Burner system shuts off after operating 6 seconds then sounds 5 beeps.	1. Short in touch pad wiring.	1. Replace touch pad and wiring harness.
Low battery power in remote.	1. Batteries are weak. LOW BATTERY is shown in remote display.	1. Replace batteries in remote.

TROUBLESHOOTING

Continued

OBSERVED PROBLEM	POSSIBLE CAUSE	REMEDY
Burner system shuts off. Control module sounds 2 cycles of 3 beeps.	1. Faulty control module	1. Replace control module.
Burner system shuts off. Control module sounds 2 cycles of 3 beeps.	1. Remote and control module not communicating properly	1. Follow Pairing instructions on page 28 to re-pair remote to control module.
	2. Faulty control module	2. Replace control module
Burner system shuts off. Control module sounds 20 beeps.	1. Loss of communication between control module and remote after 18 minutes.	1. Either the remote is too far from the burner system or the remote needs new batteries. The remote should work within 20 feet of the burner system. If it does not, replace the batteries in the remote and battery supply box.
Burner system shuts off. Control module sounds 1 long beep.	1. Control module is too hot	1. Check to see the fireplace size meets the minimum requirements. Call technical service.
Burner systems shuts off.	1. The SAFETY temperature setting in the remote has shut the burner system off.	1. The remote includes a shut off that is preset at 40C (104F). If the remote is placed in a location that is at or above this temperature it will shut the burner system off. Placing the remote on a mantel may result in this problem. If it occurs, relocate the remote to a cooler location.
Burner system lights or shuts off without touching the remote.	1. More than one burner system is present and operating on the same frequency.	1. Follow Pairing instructions on page 28 to re-pair remote to control module.

TROUBLESHOOTING

Continued

OBSERVED PROBLEM	POSSIBLE CAUSE	REMEDY
Burners do not light after ODS/pilot is lit	1. Inlet gas pressure is too low	1. Contact local natural or propane/LP gas company
	2. Burner orifice(s) clogged	2. Clean burner(s) (see <i>Cleaning and Maintenance</i> , page 33) or replace burner orifice(s)
	3. Mislocated crossover tube	3. Contact qualified service person
Delayed ignition of one or both burners	1. Manifold pressure is too low	1. Contact local natural or propane/LP gas company
	2. Burner orifice(s) clogged	2. Clean burner(s) (see <i>Cleaning and Maintenance</i> , page 33) or replace burner orifice(s)
	3. Mislocated crossover tube	3. Contact qualified service person
Burner backfiring during combustion	1. Burner orifice is clogged or damaged	1. Clean burner (see <i>Cleaning and Maintenance</i> , page 33) or replace burner orifice
	2. Damaged burner	2. Replace damaged burner
	3. Gas regulator defective	3. Replace gas regulator
Yellow flame in middle burner during burner combustion	1. Not enough air	1. Check burner(s) for dirt and debris. If found, clean burner(s) (see <i>Cleaning and Maintenance</i> , page 33)
	2. Gas regulator defective	2. Replace gas regulator
Slight smoke or odor during initial operation	1. Residues from manufacturing processes and logs curing	1. Problem will stop after a few hours of operation
Heater produces a whistling noise when burners are lit	1. Set the unit to HI by using the remote when burners are cold	1. Set the unit to LO by using the remote and let warm up for a minute
	2. Air in gas line	2. Operate burners until air is removed from line. Have gas line checked by local natural or propane/LP gas company
	3. Air passageways on heater blocked	3. Observe minimum installation clearances (see pages 9 through 12)
	4. Dirty or partially clogged burner orifice(s)	4. Clean burners (see <i>Cleaning and Maintenance</i> , page 33) or replace burner orifice(s)
White powder residue forming within burner box or on adjacent walls or furniture	1. When heated, vapors from furniture polish, wax, carpet cleaners, etc. may turn into white powder residue	1. Turn heater off when using furniture polish, wax, carpet cleaners or similar products
Moisture/condensation noticed on windows	1. Not enough combustion/ventilation air	1. Refer to <i>Air for Combustion and Ventilation</i> requirements (page 6)
Heater produces a clicking/ticking noise just after burners are lit or shut off	1. Metal expanding while heating or contracting while cooling	1. This is normal with most heaters. If noise is excessive, contact qualified service person

TROUBLESHOOTING

Continued



WARNING: If you smell gas

- **Shut off gas supply.**
- **Do not try to light any appliance.**
- **Do not touch any electrical switch; do not use any phone in your building.**
- **Immediately call your gas supplier from a neighbor's phone. Follow the gas supplier's instructions.**
- **If you cannot reach your gas supplier, call the fire department.**

IMPORTANT: Operating heater where impurities in air exist may create odors. Cleaning supplies, paint, paint remover, cigarette smoke, cements and glues, new carpet or textiles, etc., create fumes. These fumes may mix with combustion air and create odors. These odors will disappear over time.

OBSERVED PROBLEM	POSSIBLE CAUSE	REMEDY
Heater produces unwanted odors	1. Heater burning vapors from paint, hair spray, glues, cleaners, chemicals, new carpet, etc. (See <i>IMPORTANT</i> statement above)	1. Open window to ventilate room. Stop using odor causing products while heater is running
	2. Low fuel supply (propane/LP only)	2. Refill supply tank (propane/LP only)
	3. Gas leak. See Warning statement at top of page	3. Locate and correct all leaks (see <i>Checking Gas Connections</i> , page 15)
Heater shuts off in use (ODS operates)	1. Not enough fresh air is available	1. Open window and/or door for ventilation
	2. Low line pressure	2. Contact local natural or propane/LP gas company
	3. ODS/pilot is partially clogged	3. Clean ODS/pilot (see <i>Cleaning and Maintenance</i> , page 33)
Gas odor even when control knob is in OFF position	1. Gas leak. See Warning statement at top of page	1. Locate and correct all leaks (see <i>Checking Gas Connections</i> , page 15)
	2. Control valve or gas control defective	2. Replace control valve or gas control
Gas odor during combustion	1. Foreign matter between control valve and burner	1. Take apart gas tubing and remove foreign matter
	2. Gas leak. See Warning statement at top of page	2. Locate and correct all leaks (see <i>Checking Gas Connections</i> , page 15)
Log set cycles to pilot, but room temperature drops to a lower than ideal level before log set comes back on	1. Optional Hand-held remote control is too close to heater	1. Move hand-held remote control unit farther away from the heater

SERVICE HINTS

When Gas Pressure Is Too Low

- pilot will not stay lit
- burners will have delayed ignition
- heater will not produce specified heat
- propane/LP gas supply may be low

You may feel your gas pressure is too low. If so, contact your local propane/LP or natural gas supplier.

TECHNICAL SERVICE

You may have further questions about installation, operation or troubleshooting. If so, contact INNOVATIVE HEARTH PRODUCTS at 1-800-655-2008. When calling please have your model and serial numbers of your heater ready.

You can also visit INNOVATIVE HEARTH PRODUCTS technical services web site at www.IHP.US.com.

REPLACEMENT PARTS

Note: Use only original replacement parts. This will protect your warranty coverage for parts replaced under warranty.

Contact authorized dealers of this product. If they can't supply original replacement part(s), call INNOVATIVE HEARTH PRODUCTS at 1-800-655-2008.

When calling, have ready

- your name
- your address
- model and serial numbers of your heater
- how heater was malfunctioning
- type of gas used (propane/LP or natural gas)
- purchase date

Usually, we will ask you to return the part to the factory.

ACCESSORIES

Purchase these heater accessories from your local dealer. If they can not supply these accessories, call INNOVATIVE HEARTH PRODUCTS at 1-800-655-2008 for referral information. You can also write to the address listed on the back page of this manual.

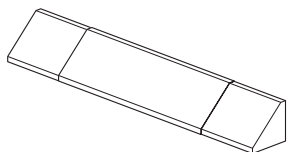

FIREPLACE HOOD

Black - GA6050

Brushed Brass - GA6053

For all models. Helps deflect heat away from mantel or wall above fireplace. Fits openings 28" to 48" wide.

LAVA ROCK - GA6060

For all models. Order when additional rock is desired.

VENT-FREE VCT AND VRT SERIES FIREBOXES

Available in 32", 36" and 42" models. Flush face and Louver models available with and without brick.

(FLOOR MEDIA KIT - FM100

For all models. Includes lava rock, burner embers, and burner cinders

CONTROL COVER KIT - CC100

For all models. Includes control cover log and 6 unique fall-away logs.

PARTS

REMOTE-READY CONTROL MODELS BGE18NE, BGE18PE, BGE2436NE, BGE2436PE

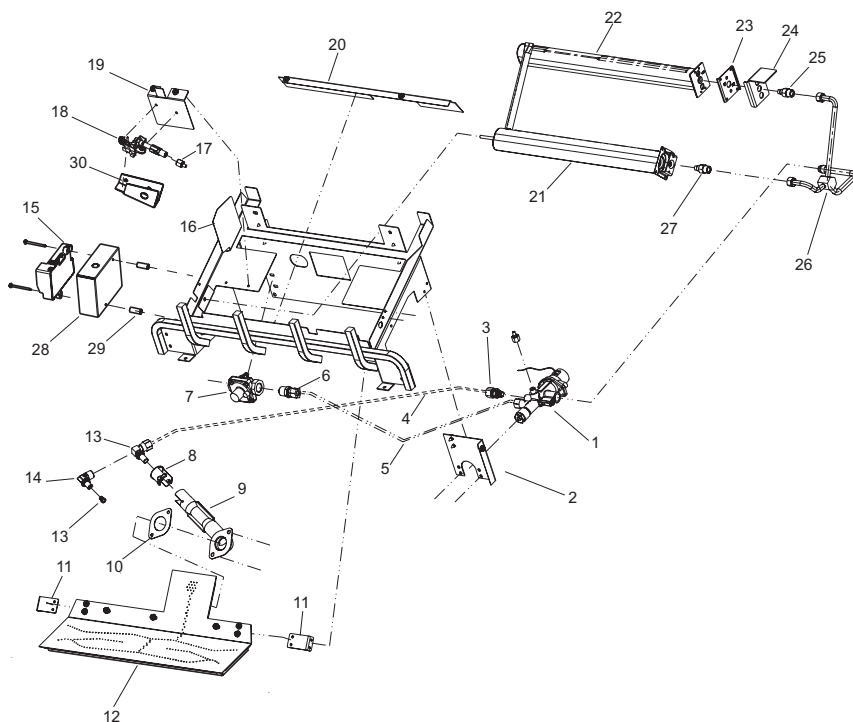

PARTS AVAILABLE NOT SHOWN

KEY NO.	PART NO.	DESCRIPTION	BGE18NE	BGE18PE	BGE2436NE	BGE2436PE	QTY.
	120466-01	Flex Tube	•	•	•	•	1
	100563-01	Warning Plate	•	•	•	•	1
	125782-01	Lighting Instruction Plate	•	•	•	•	1
	100639-12	Caution Decal	•	•	•	•	1
	101137-02	Hardware Kit	•	•	•	•	1
	GA6060	Lava Rock	•	•	•	•	1
	125557-01	Left Ember Chunk #1			•	•	1
	125557-02	Middle Ember Chunk #2			•	•	1
	125557-03	Right Ember Chunk #3			•	•	1
	125070-01	Platinum Embers	•	•	•	•	1
	125071-01	Rockwool Embers	•	•	•	•	1
	126563-01	Control, Remote Skytech	•	•	•	•	1
	120761-01RVCK	Bracket, Left Log Support			•	•	1
	125499-01	Bracket, Right Log Support			•	•	1
	125781-01	Harness, Pilot Ignitor	•	•	•	•	1
	125783-01	Screw, Min. Rate	•				1
	125783-02	Screw, Min. Rate		•			1
	125783-03	Screw, Min. Rate			•		1
	125783-04	Screw, Min. Rate				•	1
	125776-01	Supply, Battery Power	•	•	•	•	1
	125882-01	Touch Pad Manual Control	•	•	•	•	1
	125882-02	Touch Pad Wire Harness	•	•	•	•	1

** Not a field replaceable part.

PARTS

This list contains replaceable parts used in your heater. When ordering parts, follow the instructions listed under Replacement Parts on page 51 of this manual.

KEY NO.	PART NO.	DESCRIPTION	BGE18NE	BGE18PE	BGE2436NE	BGE2436PE	QTY.
1	125919-01	Electronic Valve Kit	•		•		1
	125919-04	Electronic Valve Kit		•		•	1
2	125800-01	Bracket, Valve		•	•	•	1
3	125816-01	Fitting, Tube .375 - .125 NPTF	•	•	•	•	1
4	125817-02	Tube, Orifice to Valve			•	•	2
5	125817-01	Tube, Regulator to Valve	•	•	•	•	1
6	098264-02	Connector, Male 3/8 NPTF	•	•	•	•	1
7	099415-24	Regulator, Gas LP.		•		•	1
	099415-28	Regulator, Gas NG.	•		•		1
8	112829-02	Shutter, Air		•	•	•	1
9	119321-01	Tube, Venturi	•	•	•	•	1
10	119795-01	Gasket, Burner	•	•	•	•	1
11	125301-01	Bracket, Pan Burner Support	•	•	•	•	2
12	125306-01	Assy, Pan Burner BGE2436			•	•	1
	125306-02	Assy, Pan Burner BGE18	•	•			1
13	111819-10	Orifice, Elbow P53 95 110	•			•	1
	111819-06	Orifice, Elbow P53 95 220			•		1
	099056-45	Orifice, 0.028 (PAN)		•			1
14	124933-01	Orifice, Holder 90° Elbow		•			1
15	125777-01	Module, Control Board	•	•	•	•	1
16							
17	099387-08	Tube, Pilot	•	•	•	•	1
18	125780-01	Pilot, Electric (NG)	•		•		1
	125780-02	Pilot, Electric (LP)		•		•	1
19	112713-01SA	Bracket, Pilot	•				1
	112713-02RV	Bracket, Pilot		•	•		1
	112713-04	Bracket, Pilot				•	1
20	125489-01	Shield, Air 18" BGE	•	•			1
	125489-02	Shield, Air 24/30/36" BGE			•	•	1
21	112465-01	Burner 18" Ramp Front	•	•			1
	112465-02	Burner 24/30" Ramp Front			•	•	1
22	112466-01	Burner 18" Ramp Rear	•	•			1
	112466-02	Burner 24/30" Ramp Rear			•	•	1
23	107634-01	Plate, Gas (NG only)	•		•		1
24	121005-01RV	Bracket, Air Shield				•	1
25	101004-10	Injector (.0453) Rear Burner				•	1
	101004-11	Injector (.067) Rear Burner			•		1
	101004-12	Injector (.0595) Rear Burner	•				1
	101004-24	Injector (.042) Rear Burner		•			1
26	125801-01	Tube, Inlet	•	•			1
27	101004-04	Injector (.0750) Middle Burner	•				1
	101004-06	Injector (.053) Middle Burner				•	1
	101004-15	Injector (.047) Middle Burner		•			1
	101004-25	Injector (.085) Middle Burner			•		1
28	125844-01	Control Module Heat Shield	•	•	•	•	1
29	122569-01	Aluminum Spacers	•	•	•	•	2
30	125561-01	Pilot Shield		•		•	1

PARTS

LOG MODELS

LBG18-SM, LBG24-SM, LBG30-SM

This list contains replaceable parts used in your heater. When ordering parts, follow the instructions listed under Replacement Parts on page 51 of this manual.

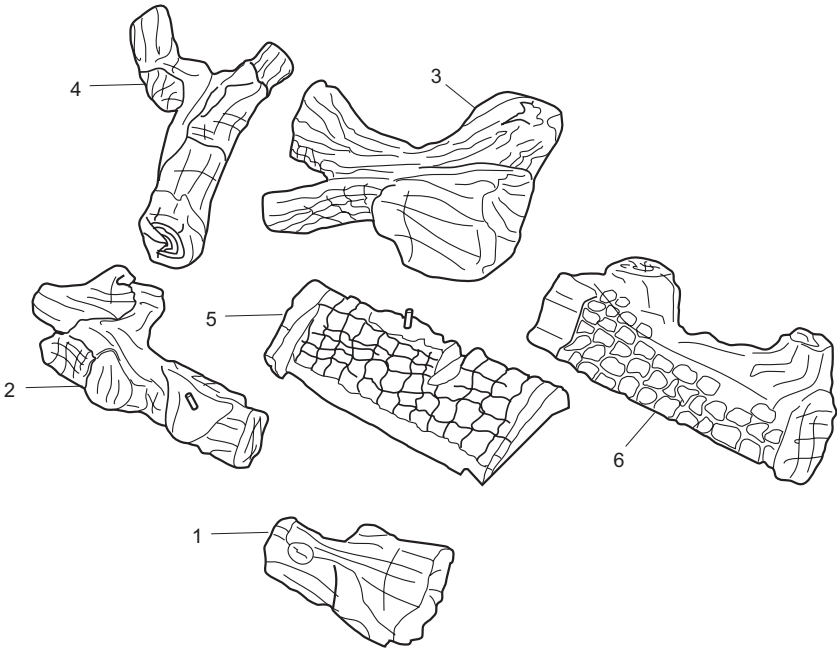

KEY NO.	MODEL NUMBER			DESCRIPTION	QTY
	LBG18-SM	LBG24-SM	LBG30-SM		
1	121699-05	121699-11	121699-17	Front Right Log	1
2	121699-04	121699-10	121699-16	Front Left Log	1
3	121699-02	125683-01	125683-01	Middle Right Log	1
4	121699-03	121699-09	121699-15	Middle Left Log	1
5	121699-01	121699-13	121699-13	Bottom Log (Remote)	1
6	121699-06	121699-12	121699-18	Rear Log	1

PARTS

LOG MODELS LBG36-SM

This list contains replaceable parts used in your heater. When ordering parts, follow the instructions listed under Replacement Parts on page 51 of this manual.

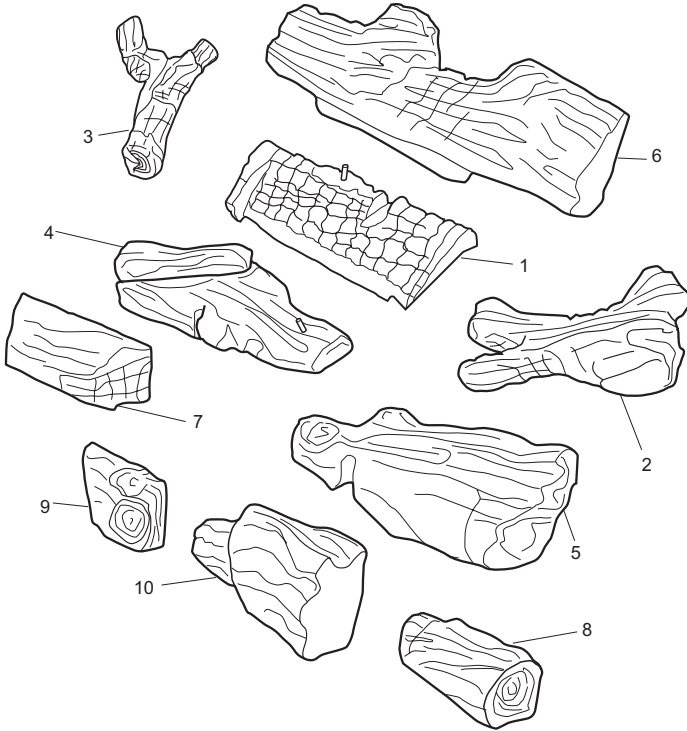

KEY NO.	MODEL NUMBER	DESCRIPTION	QTY
1	121699-13	Bottom Log	1
2	125683-01	Middle Right Log	1
3	121699-15	Middle Left Log	1
4	121699-20	Front Left Log	1
5	121699-21	Front Right Log	1
6	121699-22	Back Log	1
7	121699-23	Left Small Front Log	1
8	121699-24	Right Small Front Log	1
9	121699-25	Left Control Cover Log	1
10	121699-26	Right Control Cover Log	1

PARTS

LOG MODELS

LBG18-BM, LBG24-BM, LBG30-BM

This list contains replaceable parts used in your heater. When ordering parts, follow the instructions listed under Replacement Parts on page 51 of this manual.

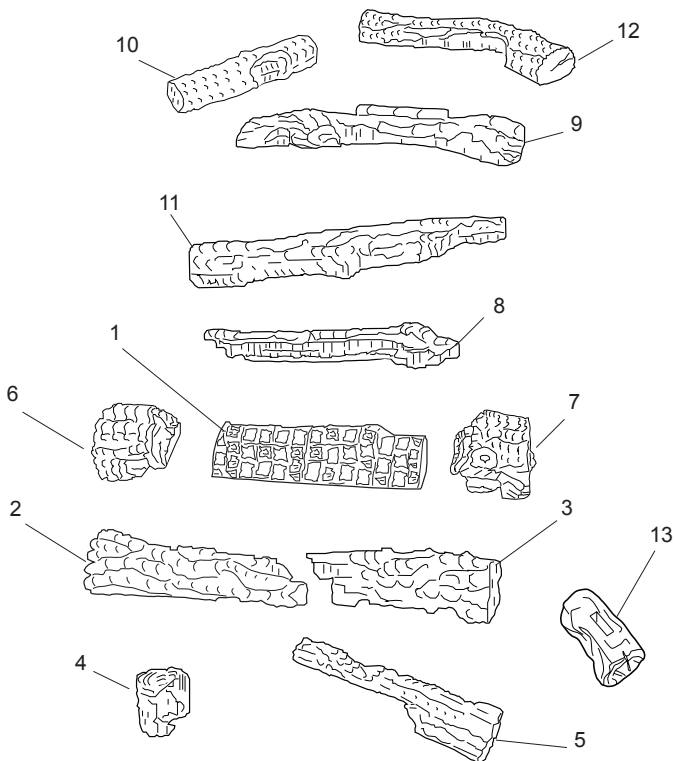

KEY NO.	PART NUMBER			DESCRIPTION	QTY
	LBG18-BM	LBG24-BM	LBG30-BM		
1	125851-01	125852-01	125852-01	Log, Ramp	1
2	125851-02	125852-02	125853-01	Log, Left Front	1
3	125851-03	125852-03	125853-02	Log, Right Front	1
4	125851-04	125852-04	125852-04	Log, Left Front Ember Bed	1
5	125851-05	125852-05	125852-05	Log, Right Front Ember Bed	1
6	125851-06	125852-06	125852-06	Log, Left Middle	1
7	125851-07	125852-07	125852-07	Log, Right Middle	1
8	125851-08	125852-08	125852-08	Log, Rear Middle	1
9	125851-09	125852-09	125852-09	Log, Rear	1
10	125851-10	125851-10	125851-10	Log, Left Top	1
11	125851-11	125852-11	125852-11	Log, Middle Crossover	1
12	125851-12	125852-12	125852-12	Log, Top Rear	1
13	125851-13	125851-13	125851-13	Log, Switch	1

Innovative Hearth Products Superior™ Brand Gas Log Set Limited Three Year Warranty

THE WARRANTY

Innovative Hearth Products Limited Three Year Warranty ("IHP") warrants your Superior™ brand Gas Log Set ("Product") to be free from defects in materials and workmanship at the time of manufacture. The logs and grate carry the Limited Three Year Warranty. After installation, if covered components manufactured by IHP are found to be defective in materials or workmanship during the Limited Three Year Warranty period and while the Product remains at the site of the original installation, IHP will, at its option, repair or replace the covered components. If repair or replacement is not commercially practical, IHP will, at its option, refund the purchase price or wholesale price of the IHP product, whichever is applicable. IHP will also pay IHP prevailing labor rates, as determined in its sole discretion, incurred in repairing or replacing such components. THERE ARE EXCLUSIONS AND LIMITATIONS to this Limited Three Year Warranty as described herein.

COVERAGE COMMENCEMENT DATE

Warranty coverage begins on the date of installation. In the case of new home construction, warranty coverage begins on the date of first occupancy of the dwelling or six months after the sale of the Product by an independent IHP dealer, whichever occurs earlier. The warranty shall commence no later than 24 months following the date of product shipment from IHP, regardless of the installation or occupancy date.

EXCLUSIONS AND LIMITATIONS

This Limited Three Year Warranty applies only if the Product is installed in the United States or Canada and only if operated and maintained in accordance with the printed instructions accompanying the Product and in compliance with all applicable installation and building codes and good trade practices.

This warranty is non-transferable and extends to the original owner only. The Product must be purchased through a listed supplier of IHP and proof of purchase must be provided. The following do not carry the Limited Three Year Warranty but are warranted as follows:

- Gas components** – Repair or replacement for one year from the date of installation.
- Remote control** – Repair or replacement for one year from the date of installation.
- Labor coverage** – Prevailing IHP labor rates apply for the warranty period of the component.

Parts not otherwise listed carry a 90 day warranty from the date of installation.

Whenever practicable, IHP will provide replacement parts, if available, for a period of 10 years from the last date of manufacture of the product.

IHP will not be responsible for: (a) damages caused by normal wear and tear, accident, riot, fire, flood or acts of God; (b) damages caused by abuse, negligence, misuse, or unauthorized alteration or repair of the Product affecting its stability or performance (The Product must be subjected to normal use. The Product is designed to burn either natural or propane gas only. Burning conventional fuels such as wood, coal or any other solid fuel will cause damage to the Product, will produce excessive temperatures and could result in a fire hazard.); (c) damages caused by failing to provide proper maintenance and service in accordance with the instructions provided with the Product; (d) damages, repairs or inefficiency resulting from faulty installation or application of the Product.

This Limited Three Year Warranty covers only parts and labor as provided herein. In no case shall IHP be responsible for materials, components or construction which are not manufactured or supplied by IHP or for the labor necessary to install, repair or remove such materials, components or construction. Additional utility bills incurred due to any malfunction or defect in equipment are not covered by this warranty. All replacement or repair components will be shipped F.O.B. from the nearest stocking IHP factory.

LIMITATION ON LIABILITY

It is expressly agreed and understood that IHP's sole obligation and the purchaser's exclusive remedy under this warranty, under any other warranty, expressed or implied, or in contract, tort or otherwise, shall be limited to replacement, repair, or refund, as specified herein.

In no event shall IHP be liable for any incidental or consequential damages caused by defects in the Product, whether such damage occurs or is discovered before or after replacement or repair, and whether such damage is caused by IHP's negligence. IHP has not made and does not make any representation or warranty of fitness for a particular use or purpose, and there is no implied condition of fitness for a particular use or purpose.

IHP makes no expressed warranties except as stated in this Limited Three Year Warranty. The duration of any implied warranty is limited to the duration of this expressed warranty.

No one is authorized to change this Limited Three Year Warranty or to create for IHP any other obligation or liability in connection with the Product. Some states and provinces do not allow the exclusion or limitation of incidental or consequential damages, so the above limitations or exclusions may not apply to you. The provisions of this Limited Three Year Warranty are in addition to and not a modification of or subtraction from any statutory warranties and other rights and remedies provided by law.

INVESTIGATION OF CLAIMS AGAINST WARRANTY

IHP reserves the right to investigate any and all claims against this Limited Three Year Warranty and to decide, in its sole discretion, upon the method of settlement.

To receive the benefits and advantages described in this Limited Three Year Warranty, the appliance must be installed and repaired by a licensed contractor approved by IHP.

Contact IHP at the address provided herein to obtain a listing of approved dealers/distributors. **IHP shall in no event be responsible for any warranty work done by a contractor that is not approved without first obtaining IHP's prior written consent.**

HOW TO REGISTER A CLAIM AGAINST WARRANTY

In order for any claim under this warranty to be valid, you must contact the IHP dealer/distributor from which you purchased the product. If you cannot locate the dealer/distributor, then you must notify IHP in writing. IHP must be notified of the claimed defect in writing within 90 days of the date of failure. Notices should be directed to the IHP Warranty Department at 1508 Elm Hill Pike, Suite 108; Nashville, TN 37210 or visit our website at WWW.SUPERIORFIREPLACES.US.COM.

WARRANTY

KEEP THIS WARRANTY

Model (located on product or identification tag) _____

Serial No. (located on product or identification tag) _____

Date Purchased _____

Keep receipt for warranty verification.



P126828-01



1508 Elm Hill Pike, Suite 108
Nashville, TN 37210
1-800-655-2008
www.IHP.US.com

126828-01
Rev. A
02/14