



## Installation and Operation Instructions

### Superior™ Unvented (Vent-Free) Gas Log Heater

P/N 126826-01 Rev. A 01/2014



P126826-01



Models

BGE18NT

BGE18PT

BGE2436NT

BGE2436PT

**INSTALLER:** Leave this manual with the appliance.  
**CONSUMER:** Retain this manual for future reference.

This appliance may be installed in an aftermarket permanently located, manufactured (mobile) home, where not prohibited by local codes. This appliance is only for use with the type of gas indicated on the rating plate. This appliance is not convertible for use with other gases.

**WARNING:** This appliance is for installation only in a solid-fuel burning masonry or UL127 factory-built fireplace or in a listed ventless firebox enclosure. It is design-certified for these installations in accordance with ANSI Z21.11.2. Exception: DO NOT install this appliance in a factory-built fireplace that includes instructions stating it has not been tested or should not be used with unvented gas logs.

This is an unvented gas-fired heater. It uses air (oxygen) from the room in which it is installed. Provisions for adequate combustion and ventilation air must be provided. Refer to Air for Combustion and Ventilation section on page 6 of this manual.

**⚠ WARNING:** If the information in these instructions is not followed exactly, a fire or explosion may result causing property damage, personal injury or loss of life.

- Do not store or use gasoline or other flammable vapors and liquids in the vicinity of this or any other appliance.
- **WHAT TO DO IF YOU SMELL GAS:**
  - Do not try to light any appliance.
  - Do not touch any electrical switch; do not use any phone in your building.
  - Immediately call your gas supplier from a neighbor's phone. Follow the gas supplier's instructions.
  - If you cannot reach your gas supplier, call the fire department.
- Installation and service must be performed by a qualified installer, service agency or the gas supplier.

## TABLE OF CONTENTS

Safety .....	2	Optional Positioning of	27
Unpacking.....	5	Thermostat Sensing Bulb .....	28
Product Identification .....	5	Troubleshooting .....	28
Local Codes.....	5	Specifications .....	32
Product Features .....	6	Parts .....	33
Air For Combustion and Ventilation .....	6	Replacement Parts .....	38
Installation .....	9	Service Hints .....	38
Operation.....	23	Technical Service.....	38
Inspecting Burners.....	25	Accessories .....	38
Cleaning and Maintenance.....	26	Warranty.....	46

## SAFETY

**⚠ WARNING:** Improper installation, adjustment, alteration, service or maintenance can cause injury or property damage. Refer to this manual for correct installation and operational procedures. For assistance or additional information consult a qualified installer, service agency or the gas supplier.

**⚠ WARNING:** This appliance is for installation only in a solid-fuel burning masonry or UL127 factory-built fireplace or in a listed ventless firebox enclosure. It is design-certified for these installations in accordance with ANSI Z21.11.2. Exception: DO NOT install this appliance in a factory-built fireplace that includes instructions stating it has not been tested or should not be used with unvented gas logs.

**⚠ WARNING:** This is an unvented gas-fired heater. It uses air (oxygen) from the room in which it is installed. Provisions for adequate combustion and ventilation air must be provided. Refer to *Air for Combustion and Ventilation* section on page 6 of this manual.

This appliance may be installed in an aftermarket,\* permanently located, manufactured (mobile) home, where not prohibited by local codes.

This appliance is only for use with the type of gas indicated on the rating plate. This appliance is not convertible for use with other gases.

\* Aftermarket: Completion of sale, not for purpose of resale, from the manufacturer

## SAFETY

*Continued*

**⚠ WARNING:** This product contains and/or generates chemicals known to the state of California to cause cancer or birth defects or other reproductive harm.

**IMPORTANT:** Read this owner's manual carefully and completely before trying to assemble, operate or service this fireplace. Improper use of this fireplace can cause serious injury or death from burns, fire, explosion, electrical shock and carbon monoxide poisoning.

**⚠ DANGER:** Carbon monoxide poisoning may lead to death!

**Carbon Monoxide Poisoning:** Early signs of carbon monoxide poisoning resemble the flu, with headaches, dizziness or nausea. If you have these signs, the fireplace may not be working properly. **Get fresh air at once!** Have fireplace serviced. Some people are more affected by carbon monoxide than others. These include pregnant women, people with heart or lung disease or anemia, those under the influence of alcohol and those at high altitudes.

Natural and Propane/LP gases are odorless. An odor-making agent is added to these gases. The odor helps you detect a gas leak. However, the odor added to the gas can fade. Gas may be present even though no odor exists.

Make certain you read and understand all warnings. Keep this manual for reference. It is your guide to safe and proper operation of this fireplace.

**⚠ WARNING:** Any change to this heater or its controls can be dangerous.

**⚠ WARNING:** Do not use a blower insert, heat exchanger insert or other accessory not approved for use with this heater.

**⚠ WARNING:** Do not allow fans to blow directly into the fireplace. Avoid any drafts that alter burner flame patterns. Ceiling fans can create drafts that alter burner flame patterns. Altered burner patterns can cause sooting.

Due to high temperatures, the appliance should be located out of traffic and away from furniture and draperies.

Do not place clothing or other flammable material on or near the appliance. Never place any objects on the heater.

Heater base assembly becomes very hot when running heater. Keep children and adults away from hot surface to avoid burns or clothing ignition. Heater will remain hot for a time after shutdown. Allow surface to cool before touching.

Carefully supervise young children when they are in the room with heater. When using the hand-held remote accessory, keep selector switch in the OFF position to prevent children from turning on burners with remote.

You must operate this heater with the fireplace screen and hood in place. Make sure fireplace screen and hood are in place before running heater. The fireplace screen shall have openings for introduction of combustion air.

Keep the appliance area clear and free from combustible materials, gasoline and other flammable vapors and liquids.

# SAFETY

## Continued

1. This appliance is only for use with the type of gas indicated on the rating plate. This appliance is not convertible for use with other gases.
2. Do not place propane/LP supply tank(s) inside any structure. Locate propane/LP supply tank(s) outdoors (propane/LP units only).
3. If you smell gas
  - shut off gas supply
  - do not try to light any appliance
  - do not touch any electrical switch; do not use any phone in your building
  - immediately call your gas supplier from a neighbor's phone. Follow the gas supplier's instructions
  - if you cannot reach your gas supplier, call the fire department
4. This heater shall not be installed as a vented appliance.
5. Before installing in a solid fuel burning fireplace, the chimney flue and firebox must be cleaned of soot, creosote, ashes and loose paint by a qualified chimney cleaner. Creosote will ignite if highly heated. A dirty chimney flue may create and distribute soot within the house. Inspect chimney flue for damage. If damaged, repair flue and firebox before operating heater.
6. Do not burn solid-fuel in a fireplace in which a vent-free room heater is installed.
7. If fireplace has glass doors, never operate this heater with glass doors closed. Any glass doors shall be fully opened when the appliance is in operation. If you operate heater with doors closed, heat buildup inside fireplace will cause glass to burst. Make sure there are no obstructions across openings of fireplace.
8. To prevent the creation of soot, follow the instructions in Cleaning and Maintenance, page 29.
9. Before using furniture polish, wax, carpet cleaner or similar products, turn heater off. If heated, the vapors from these products may create a white powder residue within burner box or on adjacent walls and furniture.
10. This heater needs fresh, outside air ventilation to run properly. This heater has an Oxygen Depletion Sensing (ODS) safety shutoff system. The ODS shuts down the heater if enough fresh air is not available. See Air for Combustion and Ventilation, page 6. If heater keeps shutting off, see Troubleshooting, page 31.
11. Do not run heater
  - where flammable liquids or vapors are used or stored
  - under dusty conditions
12. Do not use this heater to cook food or burn paper or other objects.
13. Do not use heater if any part has been exposed to or under water. Immediately call a qualified service technician to inspect the room heater and to replace any part of the control system and any gas control which has been under water.
14. Do not operate heater if any log is broken. Do not operate heater if a log is chipped (dime-sized or larger).
15. Turn heater off and let cool before servicing, installing or repairing. Only a qualified service person should install, service or repair heater.
16. Operating heater above elevations of 4,500 feet may cause pilot outage.
17. To prevent performance problems, do not use propane/LP fuel tank of less than 100 lb. capacity (propane/LP units only).
18. Provide adequate clearances around air openings.

## UNPACKING

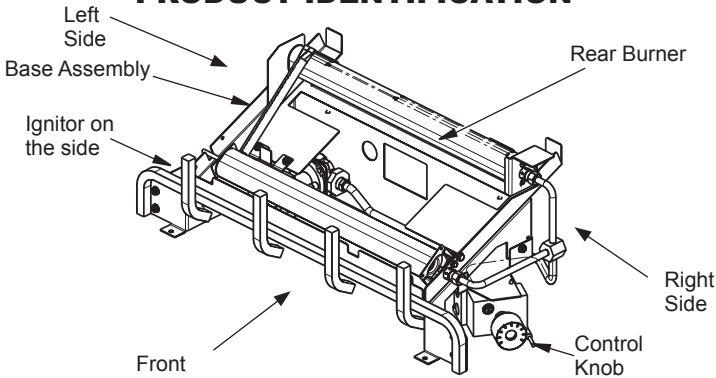
**⚠ CAUTION: Do not remove the data plates from the grate assembly. The data plates contain important warranty and safety information.**

1. Remove logs and heater base assembly from cartons.

*Note: Do not pick up heater base assembly by burners. This could damage heater. Always handle base assembly by grate.*

2. Remove all protective packaging applied to logs and heater for shipment.
3. Check heater for any shipping damage. If heater is damaged call INNOVATIVE HEARTH PRODUCTS at 1-800-655-2008 for replacement parts before returning to dealer.

## PRODUCT IDENTIFICATION



**Figure 1 - Product Identification**

## LOCAL CODES

Install and use heater with care. Follow all local codes. In the absence of local codes, use the latest edition of *The National Fuel Gas Code, ANSI Z223.1/NFPA 54\**.

\*Available from:

American National Standards Institute, Inc.  
1430 Broadway  
New York, NY 10018

National Fire Protection Association, Inc.  
Batterymarch Park  
Quincy, MA 02269

**State of Massachusetts:** The installation must be made by a licensed plumber or gas fitter in the Commonwealth of Massachusetts.

Sellers of unvented propane or natural gas-fired supplemental room heaters shall provide to each purchaser a copy of 527 CMR 30 upon sale of the unit.

Vent-free gas products are prohibited for bedroom and bathroom installation in the Commonwealth of Massachusetts.

## PRODUCT FEATURES

### OPERATION

This heater is clean burning. It requires no outside venting. There is no heat loss out a vent or up a chimney. Heat is generated by both realistic flames and glowing coals. This heater is designed for vent-free operation with flue damper closed. It has been tested and approved to ANSI Z21.11.2 standard for unvented heaters. State and local codes in some areas prohibit the use of vent-free heaters.

### SAFETY DEVICE

This heater has a pilot with an Oxygen Depletion Sensing (ODS) safety shutoff system. The ODS/pilot is a required feature for vent-free room heaters. The ODS/pilot shuts off the heater if there is not enough fresh air.

### ELECTRONIC IGNITION SYSTEM

This heater has an electronic ignitor to light heater fuel supply.

## AIR FOR COMBUSTION AND VENTILATION

**⚠ WARNING: This heater shall not be installed in a room or space unless the required volume of indoor combustion air is provided by the method described in the *National Fuel Gas Code, ANSI Z223.1/NFPA 54, the International Fuel Gas Code, or applicable local codes. Read the following instructions to insure proper fresh air for this and other fuel-burning appliances in your home.***

Today's homes are built more energy efficient than ever. New materials, increased insulation and new construction methods help reduce heat loss in homes. Home owners weather strip and caulk around windows and doors to keep the cold air out and the warm air in. During heating months, home owners want their homes as airtight as possible.

While it is good to make your home energy efficient, your home needs to breathe. Fresh air must enter your home. All fuel-burning appliances need fresh air for proper combustion and ventilation.

Exhaust fans, fireplaces, clothes dryers and fuel burning appliances draw air from the house to operate. You must provide adequate fresh air for these appliances. This will insure proper venting of vented fuel-burning appliances.

### PROVIDING ADEQUATE VENTILATION

The following are excerpts from *National Fuel Gas Code, ANSI Z223.1/NFPA 54, Air for Combustion and Ventilation*.

All spaces in homes fall into one of the three following ventilation classifications:

1. Unusually Tight Construction
2. Unconfined Space
3. Confined Space

The information on pages 6 through 8 will help you classify your space and provide adequate ventilation.

#### Unusually Tight Construction

The air that leaks around doors and windows may provide enough fresh air for combustion and ventilation. However, in buildings of unusually tight construction, you must provide additional fresh air.

**Unusually tight construction is defined as construction where:**

- a. walls and ceilings exposed to the outside atmosphere have a continuous water vapor retarder with a rating of one perm ( $6 \times 10^{-11}$  kg per pa-sec-m<sup>2</sup>) or less with openings gasketed or sealed and
- b. weather stripping has been added on openable windows and doors and
- c. caulking or sealants are applied to areas such as joints around window and door frames, between sole plates and floors, between wall-ceiling joints, between wall panels, at penetrations for plumbing, electrical and gas lines and at other openings.

# AIR FOR COMBUSTION AND VENTILATION

Continued

If your home meets all of the three criteria above, you must provide additional fresh air. See Ventilation Air From Outdoors, page 8.

If your home does not meet all of the three criteria above, proceed to Determining Fresh-Air Flow For Heater Location, below.

## Confined and Unconfined Space

The National Fuel Gas Code, ANSI Z223.1/NFPA 54 defines a confined space as a space whose volume is less than 50 cubic feet per 1,000 Btu/hr (4.8 m<sup>3</sup> per kw) of the aggregate input rating of all appliances installed in that space and an unconfined space as a space whose volume is not less than 50 cubic feet per 1,000 Btu/hr (4.8 m<sup>3</sup> per kw) of the aggregate input rating of all appliances installed in that space. Rooms communicating directly with the space in which the appliances are installed\*, through openings not furnished with doors, are considered a part of the unconfined space.

\* Adjoining rooms are communicating only if there are doorless passageways or ventilation grills between them.

## DETERMINING FRESH-AIR FLOW FOR HEATER LOCATION

### Determining if You Have a Confined or Unconfined Space

Use this work sheet to determine if you have a confined or unconfined space.

**Space:** Includes the room in which you will install fireplace plus any adjoining rooms with doorless passageways or ventilation grills between the rooms.

- Determine the volume of the space (length x width x height).

Length x Width x Height = \_\_\_\_\_ cu. ft.  
(volume of space)

*Example:* Space size 20 ft. (length) x 16 ft. (width) x 8 ft. (ceiling height) = 2560 cu. ft. (volume of space)

If additional ventilation to adjoining room is supplied with grills or openings, add the volume of these rooms to the total volume of the space.

- Multiply the space volume by 20 to determine the maximum Btu/Hr the space can support.

\_\_\_\_\_ (volume of space) x 20 = (Maximum Btu/Hr the space can support)

*Example:* 2560 cu. ft. (volume of space) x 20 = 51,200 (maximum Btu/Hr the space can support)

- Add the Btu/Hr of all fuel burning appliances in the space.

Vent-free fireplace	_____ Btu/Hr
Gas water heater*	_____ Btu/Hr
Gas furnace	_____ Btu/Hr
Vented gas heater	_____ Btu/Hr
Gas fireplace logs	_____ Btu/Hr
Other gas appliances*	+ _____ Btu/Hr
Total	= _____ Btu/Hr

\* Do not include direct-vent gas appliances. Direct-vent draws combustion air from the outdoors and vents to the outdoors.

*Example:*

Gas water heater	_____ 40,000 Btu/Hr
Vent-free fireplace	+ _____ 33,000 Btu/Hr
Total	= _____ 73,000 Btu/Hr

- Compare the maximum Btu/Hr the space can support with the actual amount of Btu/Hr used.

\_\_\_\_\_ Btu/Hr (maximum can support)

\_\_\_\_\_ Btu/Hr (actual amount used)

*Example:* 51,200 Btu/Hr (maximum the space can support)

73,000 Btu/Hr (actual amount of Btu/Hr used)

The space in the above example is a confined space because the actual Btu/Hr used is more than the maximum Btu/Hr the space can support. You must provide additional fresh air. Your options are as follows:

- Rework worksheet, adding the space of an adjoining room. If the extra space provides an unconfined space, remove door to adjoining room or add ventilation grills between rooms. See Ventilation Air From Inside Building, page 8.
- Vent room directly to the outdoors. See Ventilation Air From Outdoors, page 8.
- Install a lower Btu/Hr fireplace, if lower Btu/Hr size makes room unconfined.

If the actual Btu/Hr used is less than the maximum Btu/Hr the space can support, the space is an unconfined space. You will need no additional fresh air ventilation.

# AIR FOR COMBUSTION AND VENTILATION

Continued

**⚠️ WARNING:** If the area in which the heater may be operated does not meet the required volume for indoor combustion air, combustion and ventilation air shall be provided by one of the methods described in the *National Fuel Gas Code, ANSI Z223.1/NFPA 54*, the *International Fuel Gas Code*, or applicable local codes.

## VENTILATION AIR

### Ventilation Air From Inside Building

This fresh air would come from an adjoining unconfined space. When ventilating to an adjoining unconfined space, you must provide two permanent openings: one within 12" of the ceiling and one within 12" of the floor on the wall connecting the two spaces (see options 1 and 2, Figure 2). You can also remove door into adjoining room (see option 3, Figure 2). Follow the *National Fuel Gas Code, ANSI Z223.1/NFPA 54, Air for Combustion and Ventilation* for required size of ventilation grills or ducts.

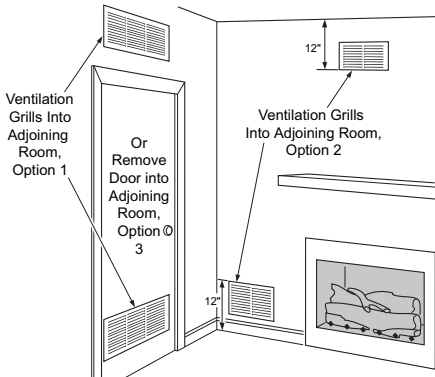


Figure 2 - Ventilation Air from Inside Building

### Ventilation Air From Outdoors

Provide extra fresh air by using ventilation grills or ducts. You must provide two permanent openings: one within 12" of the ceiling and one within 12" of the floor. Connect these items directly to the outdoors or spaces open to the outdoors. These spaces include attics and crawl spaces. Follow the *National Fuel Gas Code, ANSI Z223.1/NFPA 54, Air for Combustion and Ventilation* for required size of ventilation grills or ducts.

**IMPORTANT:** Do not provide openings for inlet or outlet air into attic if attic has a thermostat-controlled power vent. Heated air entering the attic will activate the power vent.

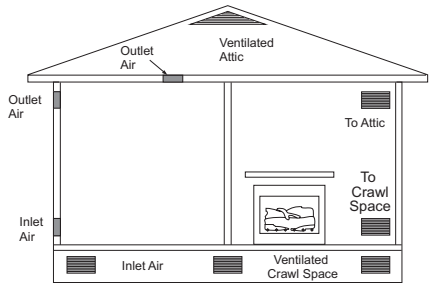


Figure 3 - Ventilation Air from Outdoors



## INSTALLATION

**NOTICE:** This heater is intended for use as supplemental heat. Use this heater along with your primary heating system. Do not install this heater as your primary heat source. If you have a central heating system, you may run system's circulating blower while using heater. This will help circulate the heat throughout the house. In the event of a power outage, you can use this heater as your primary heat source.

**WARNING:** A qualified service person must install heater. Follow all local codes.

**WARNING:** Before installing in a solid fuel burning fireplace, the chimney flue and firebox must be cleaned of soot, creosote, ashes and loose paint by a qualified chimney cleaner. Creosote will ignite if highly heated. A dirty chimney flue may create and distribute soot within the house. Inspect chimney and firebox flue for damage. If damaged, repair flue and firebox before operating heater.

**WARNING:** Any outside air ducts and/or ash dumps in the fireplace shall be permanently closed at time of appliance installation.

**WARNING:** Seal any fresh air vents or ash clean-out doors located on floor or wall of fireplace. If not, drafting may cause pilot outage or sooting. Use a heat-resistant sealant. Do not seal chimney flue damper.

**WARNING:** Never install the heater

- in a bedroom or bathroom
- in a recreational vehicle
- where curtains, furniture, clothing or other flammable objects are less than 36" from the front and 42" from top heater, For side clearances see Figure 4 page 10
- in high traffic areas
- in windy or drafty areas

**CAUTION:** This heater creates warm air currents. These currents move heat to wall surfaces next to heater. Installing heater next to vinyl or cloth wall coverings or operating heater where impurities (such as, but not limited to, tobacco smoke, aromatic candles, cleaning fluids, oil or kerosene lamps, etc.) in the air exist, may discolor walls or cause odors.

*IMPORTANT:* Vent-free heaters add moisture to the air. Although this is beneficial, installing heater in rooms without enough ventilation air may cause mildew to form from too much moisture. See [\*Air for Combustion and Ventilation\*](#), page 6.

# INSTALLATION

*Continued*

## CHECK GAS TYPE

Use the correct type of gas (natural or propane/LP). If your gas supply is not the correct gas type, do not install heater. Call dealer where you bought heater for proper type heater.

**WARNING:** This appliance is equipped for either natural gas or propane/LP gas but not both. Gas type is indicated on the rating plate. Field conversion is not permitted.

## INSTALLATION AND CLEARANCES FOR VENT-FREE OPERATION

**WARNING:** Maintain the minimum clearances. If you can, provide greater clearances from floor, ceiling and adjoining wall.

**Minimum Fireplace Clearance to Combustible Materials**  
Side Wall 16", Ceiling 42", Floor 5", Front 36"

### LOG SIZING REQUIREMENTS

Log Set Model No.	Minimum Firebox Size			
	Height	Depth	Front Width	Rear* Width
LBG18-SM	17"	13.5"	20"	14"
LBG24-SM	17"	13.5"	26"	18"
LBG30-SM	21"	13.5"	32"	22"
LBG36-SM	21"	13.5"	38"	27.5"
LBG18-BM	17"	14.5"	26"	20"
LBG24-BM	17"	14.5"	29"	22"
LBG30-BM	21"	14.5"	32"	22"

Carefully follow these instructions. This will ensure safe installation into a masonry, UL127-listed manufactured fireplace or listed vent-free firebox.

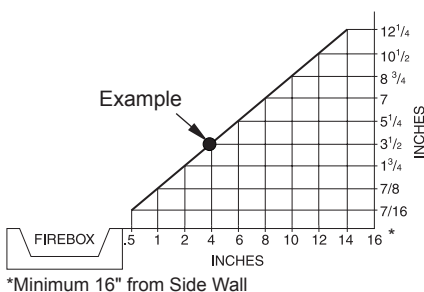
## Minimum Clearances For Side Combustible Material, Side Wall and Ceiling

A. Clearances from the side of the fireplace cabinet to any combustible material and wall should follow diagram in Figure 4.

*Example:* The face of a mantel, bookshelf, etc. is made of combustible material and protrudes 3 1/2" from the wall. This combustible material must be 4" from the side of the fireplace cabinet (see Figure 4).

*Note:* When installing your gas logs into a manufactured firebox, follow firebox manufacturer's instructions for minimum clearances to combustible materials.

B. Clearances from the top of the fireplace opening to the ceiling should not be less than 42".



**Figure 4 - Minimum Clearance for Combustible to Wall**

# INSTALLATION

*Continued*

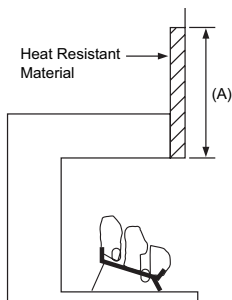
## MINIMUM NONCOMBUSTIBLE MATERIAL CLEARANCES

### If Not Using Mantel

*Note: If using a mantel proceed to If Using Mantel. If not using a mantel, follow the information on this page.*

You must have noncombustible material(s) above the fireplace opening. Noncombustible materials (such as slate, marble, tile, etc.) must be at least 1/2" thick. With sheet metal, you must have noncombustible material behind it. Noncombustible material must extend at least 8" up (for all models). If noncombustible material is less than 12", you must install the fireplace hood accessory (24", 30" and 36" Models Only). See Figure 5 for minimum clearances.

Noncombustible Material Distance (A)	Requirements for Safe Installation
12" or more	Noncombustible material OK.
Between 8" and 12"	24", 30" or 36" Models: Install fireplace hood accessory (GA6050 or GA6053 see <u>Accessories</u> , page 45). 18" Model: Noncombustible material OK.
Less than 8"	Noncombustible material must be extended to at least 8". See <u>Between 8" and 12"</u> , above. If you cannot extend material, you must operate heater with flue damper open.



**Figure 5 - Heat Resistant Material (Slate, Marble, Tile, etc.) Above Fireplace**

### If Using Mantel

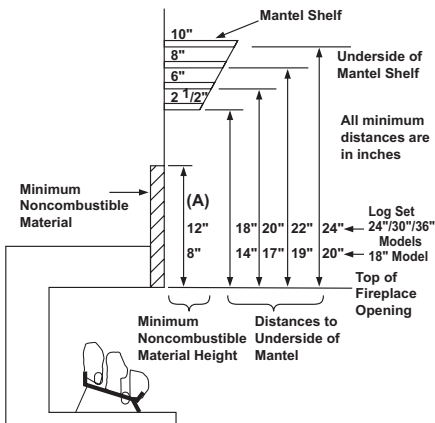
You must have noncombustible material(s) above the fireplace opening. Noncombustible materials (such as slate, marble, tile, etc.) must be at least 1/2" thick. With sheet metal, you must have noncombustible material behind it. Noncombustible material must extend at least 8" up (for all models). If noncombustible material is less than 12", you must install the fireplace hood accessory (24", 30" and 36" Models Only). Even if noncombustible material is more than 12", you may need the hood accessory to deflect heat away from your mantel shelf. See Figures 5 and 6 and Figure 7, page 9, for minimum clearances.

## MANTEL CLEARANCES

In addition to meeting noncombustible material clearances, you must also meet required clearances between fireplace opening and mantel shelf. If you do not meet the clearances listed below, you will need a hood.

### Determining Minimum Mantel Clearance

If you meet minimum clearance between mantel shelf and top of fireplace opening, a hood is not required (see Figure 6).



**Figure 6 - Minimum Mantel Clearances Without Using Hood**

# INSTALLATION

*Continued*

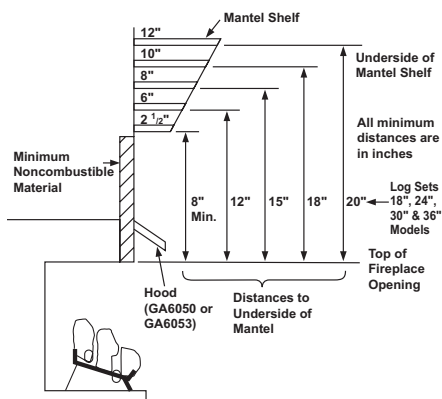
## Determining Minimum Mantel Clearance When Using a Hood

If minimum clearances in Figure 6, page 11, are not met, you must have a hood. When using a hood there are still certain minimum mantel clearances required. Follow minimum clearances shown in Figure 7, when using hood.

**NOTICE: Surface temperatures of adjacent walls and mantels become hot during operation. Walls and mantels above the firebox may become hot to the touch. If installed properly, these temperatures meet the requirement of the national product standard. Follow all minimum clearances shown in this manual.**

**NOTICE: If your installation does not meet the minimum clearances shown, you must do one of the following:**

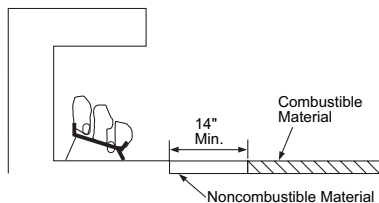
- operate the logs only with the flue damper open
- raise the mantel to an acceptable height
- remove the mantel



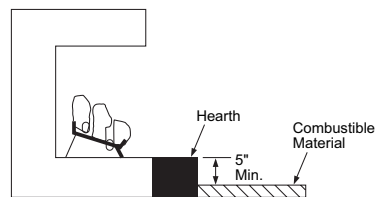
**Figure 7 - Minimum Mantel Clearances When Using Hood**

## FLOOR CLEARANCES

- A. If installing appliance on the floor level, you must maintain the minimum distance of 14" to combustibles (see Figure 8).
- B. If combustible materials are less than 14" to the fireplace, you must install appliance at least 5" above the top surface of combustible flooring including tile and carpet. (see Figure 9).



**Figure 8 - Minimum Fireplace Clearances If Installed at Floor Level**



**Figure 9 - Minimum Fireplace Clearances Above Combustible Flooring**

## INSTALLING HEATER BASE ASSEMBLY

**WARNING:** You must secure this heater to fireplace floor. If not, heater will move when you adjust controls. Moving heater may cause a gas leak.

**CAUTION:** Do not pick up heater base assembly by burners. This could damage heater. Only handle base assembly by grates.

# INSTALLATION

Continued

**⚠ WARNING:** If installing in a sunken fireplace, special care is needed. You must raise the fireplace floor to allow access to heater control panel. This will insure adequate air flow and guard against sooting and controls being damaged. Raise fireplace floor with noncombustible material. Make sure material is secure.

**IMPORTANT:** Make sure the heater burners are level. If heater is not level, heater will not work properly. For thermostat models, avoid damage to thermostat bulb. Avoid nicks or sharp bends in thermostat bulb wire. Keep thermostat bulb in mounting bracket until ready to mount base to floor. See *Optional Positioning Of Thermostat Sensing Bulb*, page 30.

## Installation Items Needed

- hardware package (provided with heater)
- approved flexible gas hose and fittings (provided) (if allowed by local codes)
- sealant (resistant to propane/LP gas, not provided)
- electric drill with 3/16" masonry drill bit

1. Apply pipe joint sealant lightly to male threads of gas fitting (provided). Connect approved flexible gas hose to gas regulator of heater (see Figure 10).

**IMPORTANT:** Hold gas regulator with wrench when connecting flexible gas hose.

2. Position heater base assembly in fireplace.
3. Mark screw locations through holes in front panel of base (see Figure 11). If installing in a brick-bottom fireplace, mark screw locations in mortar joint of bricks.
4. Remove heater base from fireplace.
5. Drill holes at marked locations using 3/16" drill bit.
6. Attach base, through holes in front panel of base, to fireplace floor using masonry screws provided in hardware package (see Figure 11).
7. Connect to gas supply. See *Connecting To Gas Supply*.

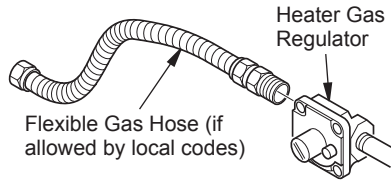


Figure 10 - Attaching Flexible Gas Hose to Heater Gas Regulator (Thermostatically-Controlled Models Only)

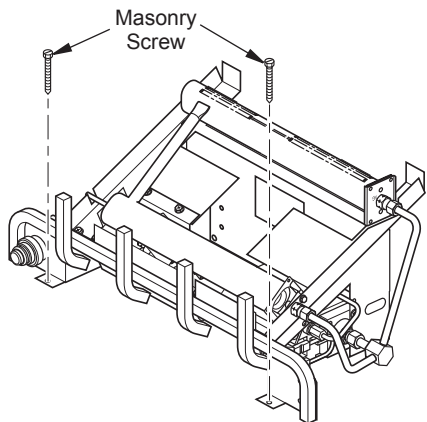


Figure 11 - Attaching Base to Fireplace Floor

## CONNECTING TO GAS SUPPLY

**⚠ WARNING:** This appliance requires a 1/2" NPT (National Pipe Thread) inlet connection to the pressure regulator.

**⚠ WARNING:** A qualified service person must connect heater to gas supply. Follow all local codes.

**⚠ CAUTION:** Never connect propane/LP fireplace directly to the propane/LP supply. This heater requires an external regulator (not supplied). Install the external regulator between the heater and propane/LP supply.

# INSTALLATION

*Continued*

**⚠ WARNING: Never connect natural gas fireplace to private (non-utility) gas wells. This gas is commonly known as wellhead gas.**

## Installation Items Needed

Before installing heater, make sure you have the items listed below.

- external regulator (supplied by installer)
- piping (check local codes)
- sealant (resistant to propane/LP gas)
- equipment shutoff valve \*
- test gauge connection \*
- sediment trap
- tee joint
- pipe wrench
- approved flexible gas line with gas connector (if allowed by local codes) (not provided)

\* An equipment shutoff valve with 1/8" NPT tap is an acceptable alternative to test gauge connection. Purchase the optional equipment shutoff valve from your dealer.

For propane/LP units, the installer must supply an external regulator. The external regulator will reduce incoming gas pressure. You must reduce incoming gas pressure to between 11" and 14" of water. If you do not reduce incoming gas pressure, heater regulator damage could occur. Install external regulator with the vent pointing down as shown in Figure 14. Pointing the vent down protects it from freezing rain or sleet.

**⚠ CAUTION: Use only new, black iron or steel pipe. Internally-tinned copper tubing may be used in certain areas. Check your local codes. Use pipe of 1/2" diameter or greater to allow proper gas volume to heater. If pipe is too small, undue loss of volume will occur.**

Installation must include an equipment shutoff valve, union and plugged 1/8" NPT tap. Locate NPT tap within reach for test gauge hook up. NPT tap must be upstream from heater (see Figure 12 or Figure 13 on page 15, depending on your model).

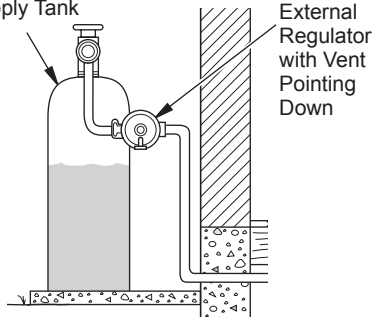
**IMPORTANT:** Install equipment shutoff valve in an accessible location. The equipment shutoff valve is for turning on or shutting off the gas to the appliance.

Check your building codes for any special requirements for locating equipment shutoff valve to fireplaces.

Apply pipe joint sealant lightly to male NPT threads. This will prevent excess sealant from going into pipe. Excess sealant in pipe could result in clogged heater valves.

**⚠ WARNING: Use pipe joint sealant that is resistant to liquid petroleum (LP) gas.**

Propane/LP  
Supply Tank

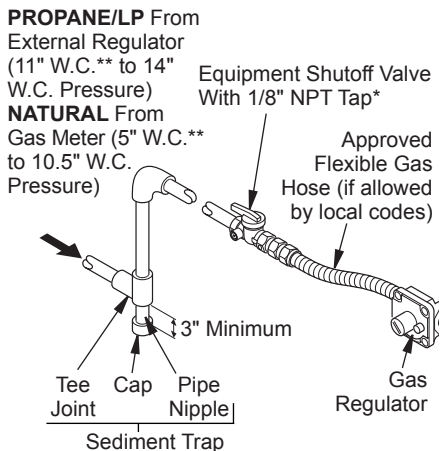


**Figure 12 - External Regulator With Vent Pointing Down**

We recommend that you install a sediment trap in supply line as shown in Figure 13, page 15. Locate sediment trap where it is within reach for cleaning. Install in piping system between fuel supply and heater. Locate sediment trap where trapped matter is not likely to freeze. A sediment trap traps moisture and contaminants. This keeps them from going into heater controls. If sediment trap is not installed or is installed wrong, heater may not run properly.

# INSTALLATION

*Continued*



*Figure 13 - Gas Connection*

**CAUTION:** Avoid damage to regulator. Hold gas regulator with wrench when connecting it to gas piping and/or fittings.

## CHECKING GAS CONNECTIONS

**WARNING:** Test all gas piping and connections, internal and external to unit, for leaks after installing or servicing. Correct all leaks at once.

**WARNING:** Never use an open flame to check for a leak. Apply a noncorrosive leak detection fluid to all joints. Bubbles forming show a leak. Correct all leaks at once.

**CAUTION:** Make sure external regulator has been installed between propane/LP supply and heater. See guidelines under *Connecting to Gas Supply*, page 13.

## PRESSURE TESTING GAS SUPPLY PIPING SYSTEM

### Test Pressures In Excess Of 1/2 PSIG (3.5 kPa)

1. Disconnect appliance with its appliance main gas valve (control valve) and equipment shutoff valve from gas supply piping system. Pressures in excess of 1/2 psig (3.5 kPa) will damage heater regulator.
2. Cap off open end of gas pipe where equipment shutoff valve was connected.
3. Pressurize supply piping system by either opening propane/LP supply tank valve for propane/LP gas or opening main gas valve located on or near gas meter for natural gas or using compressed air.
4. Check all joints of gas supply piping system. Apply noncorrosive leak detection fluid to all joints. Bubbles forming show a leak.
5. Correct all leaks at once.
6. Reconnect heater and equipment shutoff valve to gas supply. Check reconnected fittings for leaks.

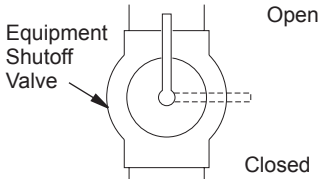
### Test Pressures Equal To or Less Than 1/2 PSIG (3.5 kPa)

1. Close equipment shutoff valve (see Figure 14, page 16).
2. Pressurize supply piping system by either opening propane/LP supply tank valve for propane/LP gas or opening main gas valve located on or near gas meter for natural gas or using compressed air.
3. Check all joints from gas meter to equipment shutoff valve for natural gas or propane/LP supply to equipment shutoff valve for propane/LP (see Figure 15 or 16, page 16). Apply noncorrosive leak detection fluid to all joints. Bubbles forming show a leak.
4. Correct all leaks at once.

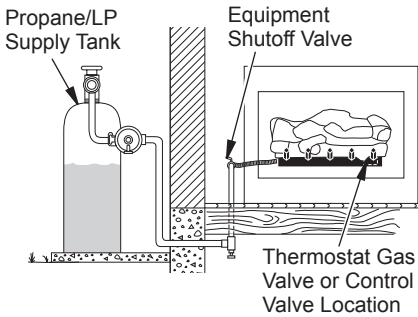


# INSTALLATION

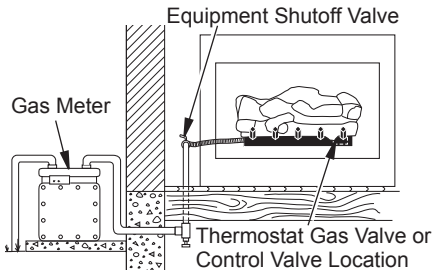
*Continued*



**Figure 14 - Equipment Shutoff Valve**



**Figure 15 - Checking Gas Joints (Propane/LP Only)**



**Figure 16 - Checking Gas Joints (Natural Gas Only)**

## PRESSURE TESTING HEATER GAS CONNECTIONS

1. Open equipment shutoff valve (see Figure 14).
2. Open main gas valve located on or near gas meter for natural gas or open propane/LP supply tank valve.
3. Make sure control knob of heater is in the OFF position.
4. Check all joints from equipment shutoff valve to thermostat gas valve (see Figure 15 or 16). Apply noncorrosive leak detection fluid to all joints. Bubbles forming show a leak.
5. Correct all leaks at once.

6. Light heater (see *Operation*, page 26, depending on your model). Check all other internal joints for leaks.
7. Turn off heater (see *To Turn Off Gas to Appliance*, page 27).

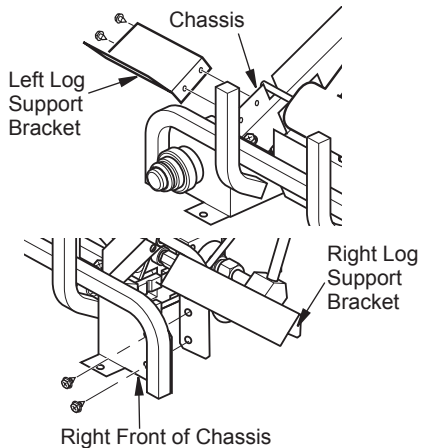
## INSTALLING LOGS

**⚠ WARNING:** Failure to position the parts in accordance with these diagrams or failure to use only parts specifically approved with this heater may result in property damage or personal injury.

### Log Support Brackets

If installing a LBG36-SM, attach log support brackets before installing logs. These brackets are provided with the BG(E)2436 series burner systems.

1. Install left bracket to left side of chassis using 2 screws provided (see Figure 17).
2. Install right bracket to right front of chassis using 2 screws provided (see Figure 17).



**Figure 17 - Installing Log Support Brackets**

## SWITCH LOG

Log sets LBG(18,24,30,36)-SM, and LBG(18,24,30)-BM come with a switch log that is not used with these burner systems. The switch log can be used as a decorative log place on the hearth. Do not place on the burner system.



# INSTALLATION

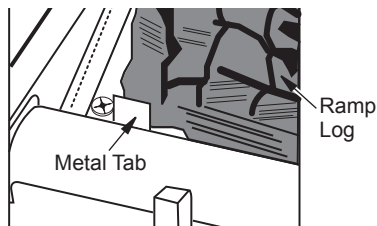
*Continued*

BGE Series Burner System - Log Compatibility Chart		
Burner System Models	Fiber Log Models	Concrete Log Models
BGE18NT, BGE18PT	LBG18-SM	LBG18-BM
BGE2436NT, BGE2436PT	LBG24-SM LBG30-SM LBG36-SM	LBG24-BM LBG30-BM

## FIBER LOG MODELS LBG(18,24,30,36)-SM

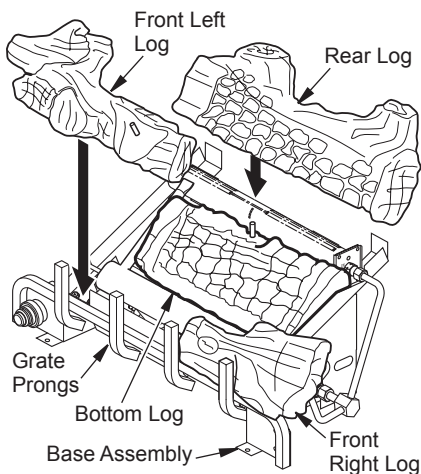
*Note: Your appliance may vary from model shown but log placement will be the same.*

1. Place bottom log in center of the base assembly as shown in Figure 18. The log must sit flat on the black sheet metal and behind the left metal tab as shown in figure 18-A.
2. Rest rear log in back corner sections of base assembly as shown in Figure 18. Make sure log is completely vertical and not leaning in toward burner where flame will touch the log.
3. Position front right log against right side of grate prongs (see Figure 18).
4. Position front left log against left side of grate prongs (see Figure 18).
5. Place middle right log over front right and bottom logs as shown in Figure 19. Be

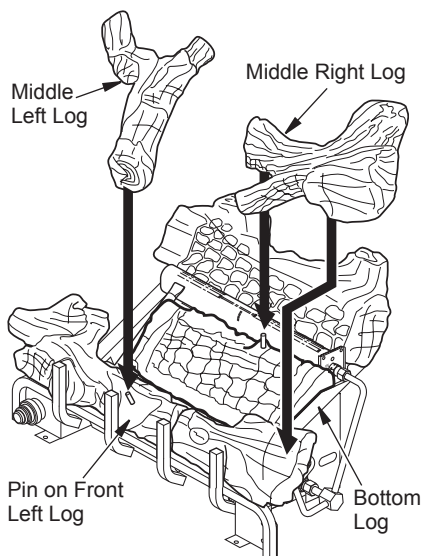


**Figure 18-A - Installing Log Set**

- sure hole in middle right log seats over pin in bottom log.
6. Place middle left log over front left and bottom logs as show in Figure 19. Be sure hole in middle left log seats over pin in front left log.



**Figure 18 - Installing Log Set**

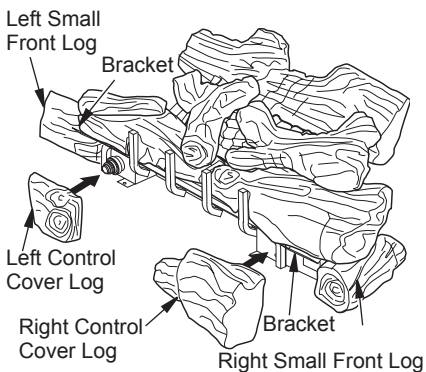


**Figure 19 - Installing Log Set**

## INSTALLATION

*Continued*

- For LTF36-SM, the front right and left logs are longer and are supported with brackets on each end (see Figure 20). Place left and right small front logs under left bracket and beside right bracket.
- For LBG36-SM, position left and right control cover logs as shown in Figure 21. These may be placed as desired to hide controls.



**Figure 20 - Installing LBG36-SM Model Control Cover Logs**



LBG(18,24,30)-SM MODELS



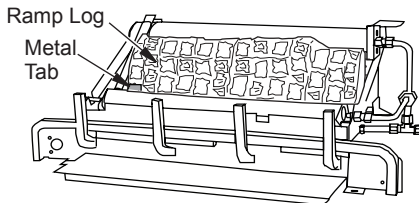
LBG36-SM MODELS

**Figure 21 - Correct Log Placement**

## CONCRETE LOG MODELS LBG (18,24,30) BM

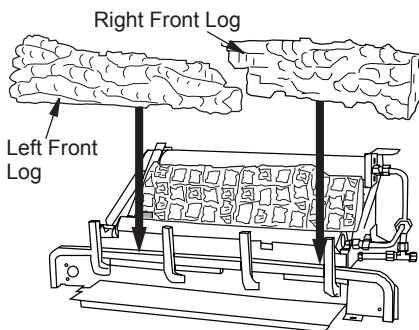
*Note: Your appliance may vary from model shown but log placement will be the same.*

- Place fiber ramp log in center of chassis as shown in Figure 22. The fiber ramp log can be identified by the shape and much lighter weight when compared to the other logs. The log must sit flat on the black sheet metal and behind the left metal tab as shown. Make sure the side marked "BOTTOM" is setting down.



**Figure 22 - Installing Fiber Ramp Log**

- Place front left (18" D-064, 24" D-057 & 30" D-038) and front right (18" D-065, 24" D-058 & 30" D-039) logs as shown in Figure 23.



**Figure 23 - Installing Left/Right Front Logs**

# INSTALLATION

## Continued

- Place left ember bed log (18" D-073, 24" & 30" D-048) as shown in Figure 24. The log has groove on one side that sets on the ember bed pan. The back side of this log needs to rest against the front of the base assembly. Make sure the flame from the ember pan does not touch the ember bed log.

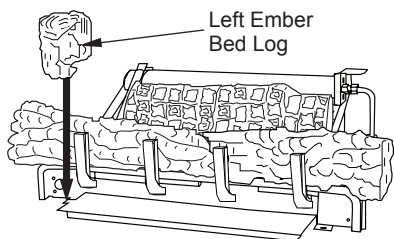


Figure 24 - Installing Left Ember Bed Log

- The left middle log (18" D-066, 24" & 30" D-040) has a groove on the bottom to sit on the chassis and has to sit on the tab on the back of the left front log as shown in Figure 26.

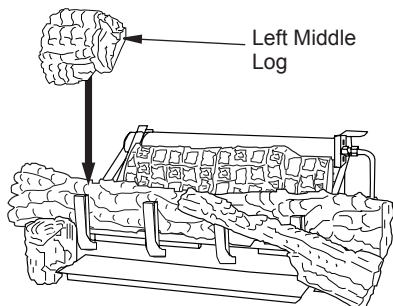


Figure 26 - Installing Left Middle Log

- The right ember bed log 24" & 30" (D-047) has a hole in the log that sets on the grate finger and the other end rest on the fireplace floor, place log as shown in Figure 25. The right ember bed logs for 18" (D-072) has a groove on the side that sets on the ember bed pan and the back of the log needs to rest against the front of the base. Make sure the flame from the ember pan does not touch the ember bed log. The back side of this log needs to rest against the front of the base assembly, make sure the flame from the ember pan does not touch the ember bed log.

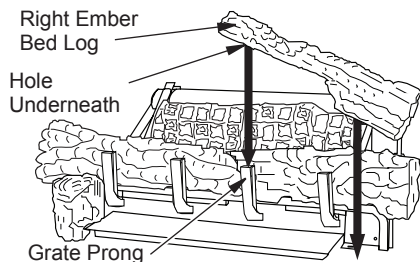


Figure 25 - Installing Right Ember Bed Log

- The right middle log (18" D-067, 24" & 30" D-041) has a groove on the bottom to sit on the chassis and has to sit on the tab on the back of the right front. The right middle log should have a recess area that fits around the ramp log as shown in Figure 27.

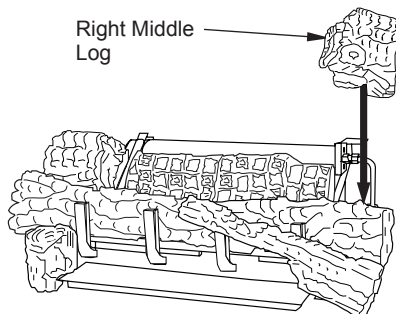
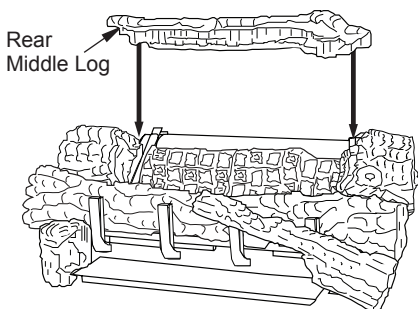


Figure 27 - Installing Right Middle Log

# INSTALLATION

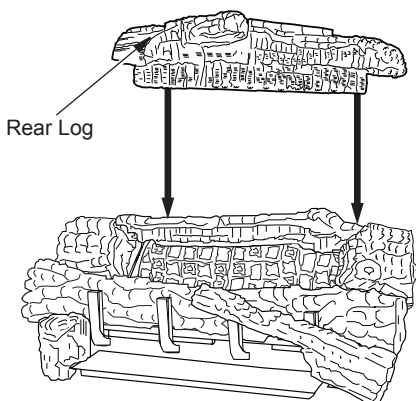
## Continued

7. The rear middle log (18" D-068, 24" & 30" D-042) should fit between the ramp log and the rear burner. The left and right middle logs have recessed areas for the rear middle log to sit into (See Figure 28). There may be a small gap between the rear middle log and the ramp log, this is normal. Be careful not to push the rear burner out of position while installing this log.



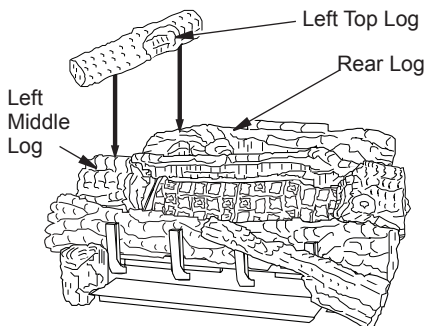
**Figure 28 - Installing Rear Middle Log**

8. Rest the rear log (18" D-069, 24" & 30" D-043) on the chassis behind the rear burner as shown in Figure 29. The bottom of the rear log will sit into the rear log supports.



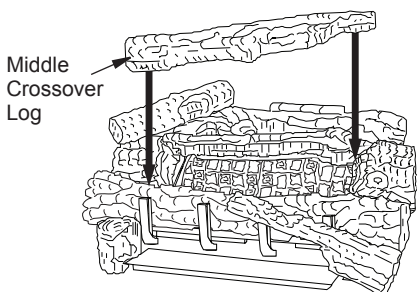
**Figure 29 - Installing Rear Log**

9. Place the left top log (D-046) onto the rear log and the left middle log. Make sure to place the projection on the bottom of the left top log into the recessed areas on the rear and left middle logs (see Figure 30).



**Figure 30 - Installing Left Top Log**

10. Rest the middle crossover log (18" D-070, 24" & 30" D-044) onto the right middle log and the left front log (see Figure 31). Make sure to match the projection on the bottom of the crossover log with the recess area in the right middle log and the left front log.

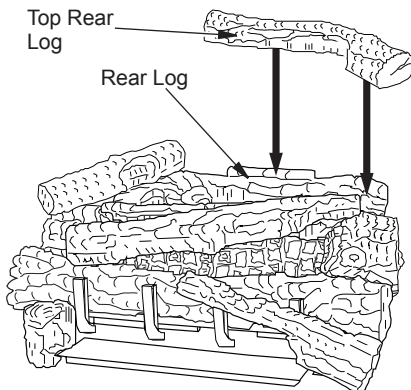


**Figure 31 - Installing Middle Crossover Log**

# INSTALLATION

*Continued*

11. Place the top rear log (18" D-071, 24" & 30" D-045) onto the rear log as shown. The rear log has a projection that will fit into the recess area on the bottom of the top rear log (see Figure 32).



**Figure 32 - Installing Top Rear Log**

## EMBER PLACEMENT - BGE SERIES BURNER SYSTEMS

**WARNING:** Do not use any other ember material not supplied with this unit.

**WARNING:** Do not operate unit without ember material correctly in place as shown in Figures 33 & 34. Do NOT place ember material anywhere else on the unit. Use only ember material supplied with unit. Excessive or incorrectly placed ember material may produce carbon monoxide or soot. If replacement embers are needed, the replacement embers must be purchased from IHP. See page 33 for part numbers.

**WARNING:** Do not use any other ember material not supplied with this unit.

**WARNING:** All previously applied loose material must be removed prior to reapplication.

1. **Ember Chunk Placement.** The BGE2436 burner systems include three ember chunks that are designed to fit over shoulder screws on the ember pan burner. The bottom of each ember chunk

has a hole for securing the ember chunk in place when it is placed over a shoulder screw. Place the ember chunks as shown in Figure 33 on page 22 by placing the ember chunk with the number "1" on the left, "2" in the center, and "3" on the right. These numbers are embossed on the back of each piece for identification purposes. Please note that BGE18 burner systems do not include ember chunks.

2. Two ember materials are supplied with this log set. Platinum Bright Embers give a bright glow appearing as hot coals. Follow instructions for the ember material you choose. Should embers need replacing, see *Parts*, page 36.

**Platinum Bright Ember placement.** Add embers to front, flat burner. Gently remove embers from bag. Separate pieces of ember material and place on surface of flat burner just behind horizontal ports as shown in Figure 34.

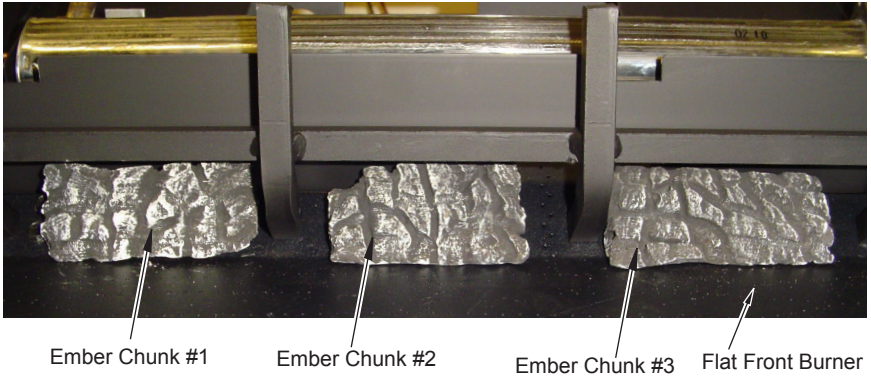
**Rock Wool placement.** Place rock wool material on front flat burner in areas away from ports as shown in Figure 35.

3. Add lava rock and small decorative logs around base of heater if desired. **DO NOT place rock or additional logs on front burner or on logs.** Placing any material on unit other than ember material on front burner may result in production of carbon monoxide or soot. Use lava rock to hide wires from switch/log to control valve. Place switch/log so the switch is easy to access.



# INSTALLATION

*Continued*



**Figure 33 - Ember Chunk Placement BGE2436 Series**



**Figure 34 - Platinum Bright Embers for BGE Series**



**Figure 35 - Placement of Rock Wool for BGE Series  
(shown with Platinum Bright Embers)**

## OPERATION

### FOR YOUR SAFETY READ BEFORE LIGHTING

**WARNING:** If you do not follow these instructions exactly, a fire or explosion may result causing property damage, personal injury or loss of life.

- A. This appliance has a pilot which must be lighted by hand. When lighting the pilot, follow these instructions exactly.
- B. **BEFORE LIGHTING** smell all around the appliance area for gas. Be sure to smell next to the floor because some gas is heavier than air and will settle on the floor.
- WHAT TO DO IF YOU SMELL GAS**
- Do not try to light any appliance.
  - Do not touch any electric switch; do not use any phone in your building.
  - Immediately call your gas supplier from a neighbor's phone. Follow the gas supplier's instructions.
  - If you cannot reach your gas supplier, call the fire department.
- C. Use only your hand to push in or turn the gas control knob. Never use tools. If the knob will not push in or turn by hand, don't try to repair it, call a qualified service technician or gas supplier. Force or attempted repair may result in a fire or explosion.
- D. Do not use this appliance if any part has been under water. Immediately call a qualified service technician to inspect the appliance and to replace any part of the control system and any gas control which has been under water.

### LIGHTING INSTRUCTIONS



**NOTICE:** During initial operation of new heater, burning logs will give off a paper-burning smell. Orange flame will also be present. Open damper or window to vent smell. This will only last a few hours.

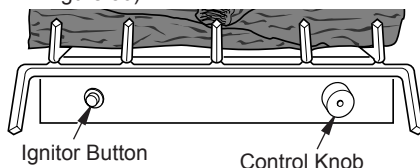
### **WARNING:**

- If fireplace has glass doors, never operate this heater with glass doors closed. If you operate heater with doors closed, heat buildup inside fireplace will cause glass to burst. Make sure there are no obstructions across openings of fireplace.
- You must operate this heater with a fireplace screen in place. Make sure fireplace screen is closed before running heater.

*Note: Home owners generally prefer to operate their heater with the chimney damper closed. This will put all the heat into the room. However, there may be times you will desire the full flames of the HI heat setting but will find the heat output excessive. You can open the chimney damper (if you have one) fully or partially to release some of the heat.*

### **WARNING:** Damper handle will be hot if heater has been running.

1. STOP! Read the safety information.
2. Make sure equipment shutoff valve is fully open.
3. Turn control knob clockwise  to the OFF position.
4. Wait five (5) minutes to clear out any gas. Then smell for gas, including near the floor. If you smell gas, STOP! Follow B in the safety information. If you don't smell gas, go to the next step.
5. Turn control knob counterclockwise  to the PILOT position. Press in control knob for five (5) seconds (see Figure 36).



**Figure 36 - Control Knob and Ignitor Button Location**

# OPERATION

## Continued

*Note: You may be running this heater for the first time after hooking up to gas supply. If so, the control knob may need to be pressed in for 30 seconds or more. This will allow air to bleed from the gas system.*

6. With control knob pressed in, press and release ignitor button. This will light pilot. The pilot is attached to the front burner. If needed, keep pressing ignitor button until pilot lights.

*Note: If pilot does not stay lit, contact a qualified service person or gas supplier for repairs. Until repairs are made, light pilot with match. To light pilot with match, see Manual Lighting Procedure.*

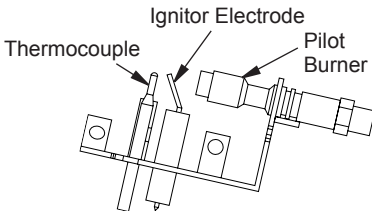
7. Keep control knob pressed in for 30 seconds after lighting pilot. After 30 seconds, release control knob.

- If control knob does not pop out when released, contact a qualified service person or gas supplier for repairs.

*Note: If pilot goes out, repeat steps 3 through 7. This heater has a safety interlock system. Wait one (1) minute for system to reset before lighting pilot again.*

8. Turn control knob counterclockwise ↶ to desired heating level. The burners should light. Set control knob to any heat level between HI and LO.
9. To leave pilot lit and shut off burners only, turn control knob clockwise ↷ to the PILOT position.

**⚠ CAUTION: Do not try to adjust heating levels by using the equipment shutoff valve.**



**Figure 37 - Pilot**

## TO TURN OFF GAS TO APPLIANCE

1. Turn control knob clockwise ↷ to the OFF position.
2. Close equipment shutoff valve (see Figure 14, page 16).

## THERMOSTAT CONTROL OPERATION

The thermostat control knob can be set to any comfort level between HI and LO. The thermostat will gradually modulate the heat output and flame height from higher to lower settings or pilot, in order to maintain the comfort level you select. The ideal comfort setting will vary by household depending upon the amount of space to be heated, the output of the central heating system, etc.

*Note: Selecting the HI setting with the control knob will cause the burner to remain fully on, without modulating down in most cases.*

## MANUAL LIGHTING PROCEDURE

1. Follow steps 1 through 5 under Lighting Instructions, page 23.
2. Press control knob and light pilot with match.
3. Keep control knob pressed in for 30 seconds after lighting pilot. After 30 seconds, release control knob. Now follow step 8 under Lighting Instructions, page 23.



# INSPECTING BURNERS

Check pilot flame pattern and burner flame patterns often.

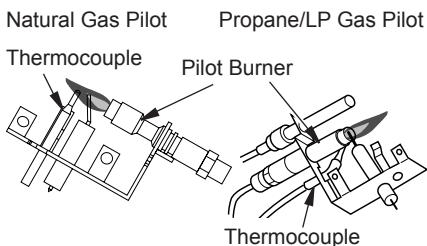
## PILOT FLAME PATTERN

Figure 38 shows a correct pilot flame pattern. Figure 39 shows an incorrect pilot flame pattern. The incorrect pilot flame is not touching the thermocouple. This will cause the thermocouple to cool. When the thermocouple cools, the heater will shut down.

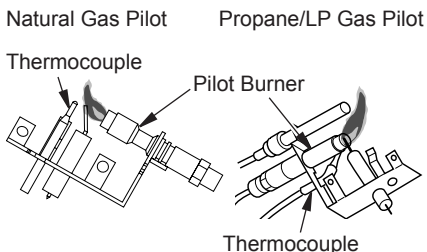
If pilot flame pattern is incorrect, as shown in Figure 39

- turn heater off (see To Turn Off Gas to Appliance, page 24).
- see Troubleshooting, page 28

*Note: The pilot flame on natural gas units will have a slight curve, but flame should be blue and have no yellow or orange color.*



**Figure 38 - Correct Pilot Flame Pattern**  
(Your pilot may vary from pilots shown)



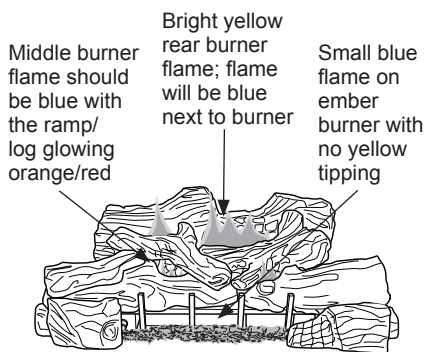
**Figure 39 - Incorrect Pilot Flame Pattern**  
(Your pilot may vary from pilots shown)

## BURNER FLAME PATTERN

Figure 40 shows correct burner flame pattern. Figure 41 shows incorrect burner flame pattern.

**WARNING:** If incorrect burner flame occurs, your heater could produce increased levels of carbon monoxide.

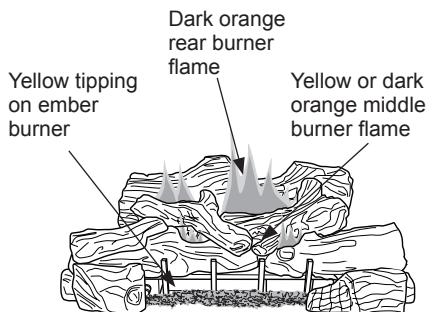
**NOTICE:** Do not mistake orange flames with yellow tipping. Dirt or other fine particles are burned by heater, causing brief patches of orange flame.



**Figure 40 - Correct Burner Flame Pattern**

If burner flame pattern is incorrect, as shown in Figure 41

- turn heater off (see To Turn Off Gas to Appliance, page 24).



**Figure 41 - Incorrect Burner Flame Pattern**

## CLEANING AND MAINTENANCE

**WARNING:** Turn off heater and let cool before cleaning.

**CAUTION:** You must keep control areas, burners and circulating air passageways of heater clean. Inspect these areas of heater before each use. Have heater inspected yearly by a qualified service person. Heater may need more frequent cleaning due to excessive lint from carpeting, pet hair, bedding material, etc.

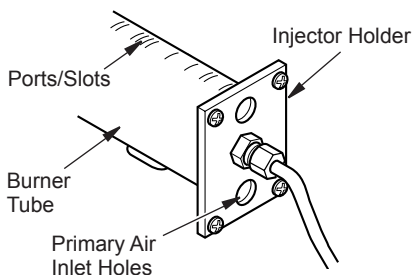
**WARNING:** Failure to keep the primary air opening(s) of the burner(s) clean may result in sooting and property damage.

### BURNER INJECTOR HOLDER AND PILOT AIR INLET HOLE

The primary air inlet holes allow the proper amount of air to mix with the gas. This provides a clean burning flame. Keep these holes clear of dust, dirt, lint and pet hair. Clean these air inlet holes prior to each heating season. Blocked air holes will create soot. We recommend that you clean the unit every three months during operation and have heater inspected yearly by a qualified service person.

We also recommend that you keep the burner tube and pilot assembly clean and free of dust and dirt. To clean these parts we recommend using compressed air no greater than 30 PSI. Your local computer store, hardware store or home center may carry compressed air in a can. If using compressed air in a can, please follow the directions on the can. If you don't follow directions on the can, you could damage the pilot assembly.

1. Shut off unit, including pilot. Allow unit to cool for at least thirty minutes.
2. Inspect burner, pilot and primary air inlet holes on injector holder for dust and dirt (see Figure 42).
3. Blow air through the ports/slots and holes in the burner.
4. Check injector holder located at the end of the burner tube again. Remove any large particles of dust, dirt, lint or pet hair with a

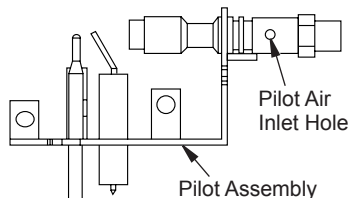


**Figure 42 - Injector Holder On Outlet Burner Tube**

soft cloth or vacuum cleaner nozzle.

5. Blow air into the primary air holes on the injector holder.
6. In case any large clumps of dust have now been pushed into the burner repeat steps 3 and 4.

Clean pilot assembly also. A yellow tip on the pilot flame indicates dust and dirt in the pilot assembly. There is a small pilot air inlet hole about 2" from where the pilot flame comes out of the pilot assembly (see Figure 43). With the unit off, lightly blow air through the air inlet hole. You may blow through a drinking straw if compressed air is not available.



**Figure 43 - Pilot Inlet Air Hole (Your pilot may vary from pilot shown)**

### LOGS

- If you remove logs for cleaning, refer to [Installing Logs](#), page 16, to properly replace logs.
- Replace log(s) if broken or chipped (dime-sized or larger).

### MAIN BURNER

Periodically inspect all burner flame holes with the heater running. All slotted burner flame holes should be open with yellow flame present. All round burner flame holes should be open with a small blue flame present. Some burner flame holes may become blocked by debris or rust, with no flame present. If so, turn off heater and let cool. Remove blockage, blocked burner flame holes will create soot.

## OPTIONAL POSITIONING OF THERMOSTAT SENSING BULB

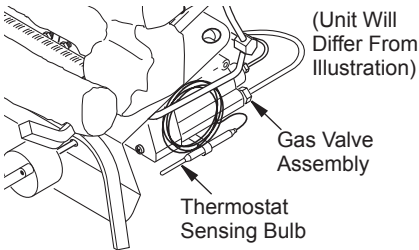
### FOR MASONRY AND FACTORY-BUILT METAL FIREPLACE

If your log set cycles to pilot, but the room temperature drops to a lower than ideal comfort level before the log set comes back on, you may want to reposition the thermostat sensing bulb.

The thermostat sensing bulb is located on the gas valve assembly. This location allows the thermostat to keep the room temperature at an ideal comfort level for most fireplace applications. If positioning the thermostat sensing bulb elsewhere, follow these directions.

Tools needed: 5/16" hex driver or socket

1. Locate the gas valve assembly and thermostat sensing bulb (see Figure 44).



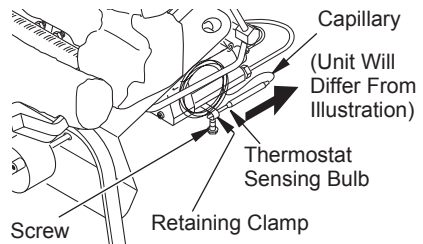
**Figure 44 - Location of Gas Valve Assembly and Thermostat Sensing Bulb**

2. With 5/16" hex driver or socket, loosen the thermostat screw. Carefully slide the thermostat sensing bulb out of the retaining clamp (see Figure 45).

*Note: Do not remove screw. Make sure you tighten screw after removing thermostat sensing bulb.*

**IMPORTANT:** Do not force or bend thermostat sensing bulb or capillary.

3. The thermostat sensing bulb may be located to the lower right front side of fireplace. Place bulb in an area that will be close to room temperature when log set is operating.



**Figure 45 - Removing Thermostat Sensing Bulb**

## TROUBLESHOOTING

**⚠ WARNING:** Turn off heater and let cool before servicing. Only a qualified service person should service and repair heater.

**⚠ CAUTION:** Never use a wire, needle or similar object to clean ODS/pilot. This can damage ODS/pilot unit.

*Note: All troubleshooting items are listed in order of operation.*

OBSERVED PROBLEM	POSSIBLE CAUSE	REMEDY
When ignitor button is pressed, there is no spark at ODS/pilot	<ol style="list-style-type: none"> <li>1. Ignitor electrode not connected to ignitor cable</li> <li>2. Ignitor cable pinched or wet</li> <li>3. Broken ignitor cable</li> <li>4. Bad ignitor</li> <li>5. Ignitor electrode positioned wrong</li> <li>6. Ignitor electrode broken</li> <li>7. Battery not installed, battery power low or battery not installed correctly (electronic ignition models only)</li> </ol>	<ol style="list-style-type: none"> <li>1. Reconnect ignitor cable</li> <li>2. Free ignitor cable if pinched by any metal or tubing. Keep ignitor cable dry</li> <li>3. Replace ignitor cable</li> <li>4. Replace ignitor</li> <li>5. Replace pilot assembly</li> <li>6. Replace pilot assembly</li> <li>7. Install new alkaline battery in electronic ignitor. Verify battery is installed correctly</li> </ol>
When ignitor button is pressed, there is spark at ODS/pilot but no ignition	<ol style="list-style-type: none"> <li>1. Gas supply turned off or equipment shutoff valve closed</li> <li>2. Control knob not in PILOT position</li> <li>3. Control knob not pressed in while in PILOT position</li> <li>4. Air in gas lines when installed</li> <li>5. Depleted gas supply (propane/LP only)</li> <li>6. ODS/pilot is clogged</li> <li>7. Gas regulator setting is not correct</li> </ol>	<ol style="list-style-type: none"> <li>1. Turn on gas supply or open equipment shutoff valve</li> <li>2. Turn control knob to PILOT position</li> <li>3. Press in control knob while in PILOT position</li> <li>4. Continue holding down control knob. Repeat igniting operation until air is removed</li> <li>5. Contact local propane/LP gas company</li> <li>6. Clean ODS/pilot (see <i>Cleaning and Maintenance</i>, page 29) or replace ODS/pilot assembly</li> <li>7. Replace gas regulator</li> </ol>

# TROUBLESHOOTING

*Continued*

OBSERVED PROBLEM	POSSIBLE CAUSE	REMEDY
ODS/pilot lights but flame goes out when control knob is released	<ol style="list-style-type: none"> <li>1. Control knob not fully pressed in</li> <li>2. Control knob not pressed in long enough</li> <li>3. Safety interlock system has been triggered</li> <li>4. Equipment shutoff valve not fully open</li> <li>5. Pilot flame not touching thermocouple, which allows thermocouple to cool, causing pilot flame to go out. This problem could be caused by one or both of the following: A) Low gas pressure B) Dirty or partially clogged ODS/pilot</li> <li>6. Thermocouple connection loose at control valve</li> <li>7. Thermocouple damaged</li> <li>8. Control valve damaged</li> </ol>	<ol style="list-style-type: none"> <li>1. Press in control knob fully</li> <li>2. After ODS/pilot lights, keep control knob pressed in 30 seconds</li> <li>3. Wait one minute for safety interlock system to reset. Repeat ignition operation</li> <li>4. Fully open equipment shut-off valve</li> <li>5. A) Contact local natural or propane/LP gas company  B) Clean ODS/pilot (see <u><i>Cleaning and Maintenance</i></u>, page 29) or replace ODS/pilot assembly</li> <li>6. Hand tighten until snug, then tighten 1/4 turn more</li> <li>7. Replace pilot assembly</li> <li>8. Replace control valve</li> </ol>
One or both burners do not light after ODS/pilot is lit	<ol style="list-style-type: none"> <li>1. Inlet gas pressure is too low</li> <li>2. Burner orifice(s) clogged</li> <li>3. Mislocated crossover tube</li> </ol>	<ol style="list-style-type: none"> <li>1. Contact local natural or propane/LP gas company</li> <li>2. Clean burner(s) (see <u><i>Cleaning and Maintenance</i></u>, page 29) or replace burner orifice(s)</li> <li>3. Contact qualified service person</li> </ol>
Delayed ignition of one or both burners	<ol style="list-style-type: none"> <li>1. Manifold pressure is too low</li> <li>2. Burner orifice(s) clogged</li> <li>3. Mislocated crossover tube</li> </ol>	<ol style="list-style-type: none"> <li>1. Contact local natural or propane/LP gas company</li> <li>2. Clean burner(s) (see <u><i>Cleaning and Maintenance</i></u>, page 29) or replace burner orifice(s)</li> <li>3. Contact qualified service person</li> </ol>
Burner backfiring during combustion	<ol style="list-style-type: none"> <li>1. Burner orifice is clogged or damaged</li> <li>2. Damaged burner</li> <li>3. Gas regulator defective</li> </ol>	<ol style="list-style-type: none"> <li>1. Clean burner (see <u><i>Cleaning and Maintenance</i></u>, page 29) or replace burner orifice</li> <li>2. Replace damaged burner</li> <li>3. Replace gas regulator</li> </ol>

## TROUBLESHOOTING

*Continued*

<b>OBSERVED PROBLEM</b>	<b>POSSIBLE CAUSE</b>	<b>REMEDY</b>
Yellow flame in front burner during burner combustion	<ol style="list-style-type: none"><li>1. Not enough air</li><li>2. Gas regulator defective</li></ol>	<ol style="list-style-type: none"><li>1. Check burner(s) for dirt and debris. If found, clean burner(s) (see <i>Cleaning and Maintenance</i>, page 29)</li><li>2. Replace gas regulator</li></ol>
Slight smoke or odor during initial operation	<ol style="list-style-type: none"><li>1. Residues from manufacturing processes and logs curing</li></ol>	<ol style="list-style-type: none"><li>1. Problem will stop after a few hours of operation</li></ol>
Heater produces a whistling noise when burners are lit	<ol style="list-style-type: none"><li>1. Turning control knob to HI position when burners are cold</li><li>2. Air in gas line</li><li>3. Air passageways on heater blocked</li><li>4. Dirty or partially clogged burner orifice(s)</li></ol>	<ol style="list-style-type: none"><li>1. Turn control knob to LO position and let warm up for a minute</li><li>2. Operate burners until air is removed from line. Have gas line checked by local natural or propane/LP gas company</li><li>3. Observe minimum installation clearances (see pages 9 through 11)</li><li>4. Clean burners (see <i>Cleaning and Maintenance</i>, page 29) or replace burner orifice(s)</li></ol>
White powder residue forming within burner box or on adjacent walls or furniture	<ol style="list-style-type: none"><li>1. When heated, vapors from furniture polish, wax, carpet cleaners, etc. may turn into white powder residue</li></ol>	<ol style="list-style-type: none"><li>1. Turn heater off when using furniture polish, wax, carpet cleaners or similar products</li></ol>
Moisture/condensation noticed on windows	<ol style="list-style-type: none"><li>1. Not enough combustion/ventilation air</li></ol>	<ol style="list-style-type: none"><li>1. Refer to <i>Air for Combustion and Ventilation</i> requirements (page 6)</li></ol>
Heater produces a clicking/ticking noise just after burners are lit or shut off	<ol style="list-style-type: none"><li>1. Metal expanding while heating or contracting while cooling</li></ol>	<ol style="list-style-type: none"><li>1. This is normal with most heaters. If noise is excessive, contact qualified service person</li></ol>

# TROUBLESHOOTING

*Continued*



**WARNING:** If you smell gas

- Shut off gas supply.
- Do not try to light any appliance.
- Do not touch any electrical switch; do not use any phone in your building.
- Immediately call your gas supplier from a neighbor's phone. Follow the gas supplier's instructions.
- If you cannot reach your gas supplier, call the fire department.

*IMPORTANT:* Operating heater where impurities in air exist may create odors. Cleaning supplies, paint, paint remover, cigarette smoke, cements and glues, new carpet or textiles, etc., create fumes. These fumes may mix with combustion air and create odors. These odors will disappear over time.

OBSERVED PROBLEM	POSSIBLE CAUSE	REMEDY
Heater produces unwanted odors	<ol style="list-style-type: none"> <li>1. Heater burning vapors from paint, hair spray, glues, cleaners, chemicals, new carpet, etc. (See <i>IMPORTANT</i> statement above)</li> <li>2. Low fuel supply (propane/LP only)</li> <li>3. Gas leak. <b>See Warning statement at top of page</b></li> </ol>	<ol style="list-style-type: none"> <li>1. Open window to ventilate room. Stop using odor causing products while heater is running</li> <li>2. Refill supply tank (propane/LP only)</li> <li>3. Locate and correct all leaks (see <i>Checking Gas Connections</i>, page 15)</li> </ol>
Heater shuts off in use (ODS operates)	<ol style="list-style-type: none"> <li>1. Not enough fresh air is available</li> <li>2. Low line pressure</li> <li>3. ODS/pilot is partially clogged</li> </ol>	<ol style="list-style-type: none"> <li>1. Open window and/or door for ventilation</li> <li>2. Contact local natural or propane/LP gas company</li> <li>3. Clean ODS/pilot (see <i>Cleaning and Maintenance</i>, page 29)</li> </ol>
Gas odor even when control knob is in OFF position	<ol style="list-style-type: none"> <li>1. Gas leak. <b>See Warning statement at top of page</b></li> <li>2. Control valve or gas control defective</li> </ol>	<ol style="list-style-type: none"> <li>1. Locate and correct all leaks (see <i>Checking Gas Connections</i>, page 15)</li> <li>2. Replace control valve or gas control</li> </ol>
Gas odor during combustion	<ol style="list-style-type: none"> <li>1. Foreign matter between control valve and burner</li> <li>2. Gas leak. <b>See Warning statement at top of page</b></li> </ol>	<ol style="list-style-type: none"> <li>1. Take apart gas tubing and remove foreign matter</li> <li>2. Locate and correct all leaks (see <i>Checking Gas Connections</i>, page 15)</li> </ol>
Log set cycles to pilot, but room temperature drops to a lower than ideal level before log set comes back on	<ol style="list-style-type: none"> <li>1. Thermostat sensing bulb needs to be repositioned</li> </ol>	<ol style="list-style-type: none"> <li>1. Reposition thermostat sensing bulb (see <i>Optional Positioning of Thermostat Sensing Bulb</i>, page 30)</li> </ol>

## SPECIFICATIONS

### BGE18PT

- Rating (Variable): 19,000/29,000 Btu/Hr
- Type Gas: Propane/LP
- Ignition: Electronic
- Manifold Pressure: 7.9" W.C.
- Inlet Gas Pressure (in. of water):  
Max - 14" W.C., Min\* - 11" W.C.

### BGE18NT

- Rating (Variable): 21,000/28,000 Btu/Hr
- Type Gas: Natural
- Ignition: Electronic
- Manifold Pressure: 3.4" W.C.
- Inlet Gas Pressure (in. of water):  
Max - 10.5" W.C., Min\* - 5" W.C.

### BGE2436PT

- Rating (Variable): 23,000/39,000 Btu/Hr
- Type Gas: Propane/LP
- Ignition: Electronic
- Manifold Pressure: 7.9" W.C.
- Inlet Gas Pressure (in. of water):  
Max - 14" W.C., Min\* - 11" W.C.

### BGE2436NT

- Rating (Variable): 25,000/39,000 Btu/Hr
- Type Gas: Natural
- Ignition: Electronic
- Manifold Pressure: 3.4" W.C.
- Inlet Gas Pressure (in. of water):  
Max - 10.5" W.C., Min\* - 5" W.C.

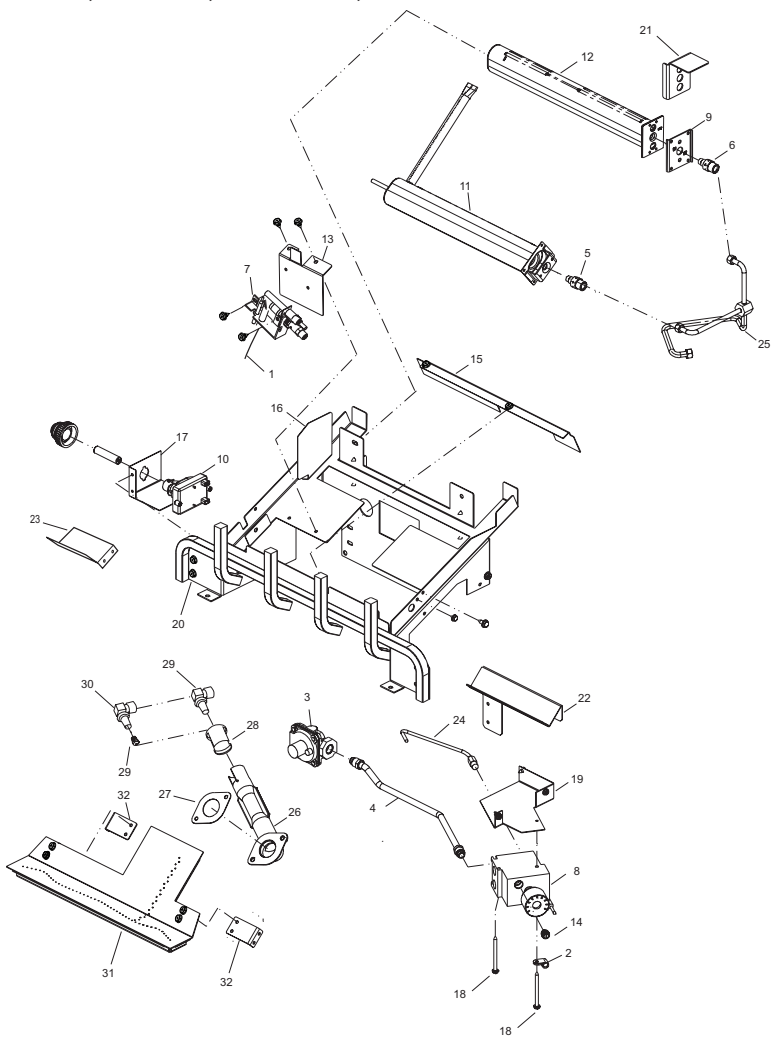
\*For purpose of input adjustment



# PARTS

## THERMOSTATICALLY CONTROLLED MODELS

BGE18NT, BGE18PT, BGE2436NT, BGE2436PT



### PARTS AVAILABLE NOT SHOWN

KEY NO.	PART NO.	DESCRIPTION	BGE18NT	BGE18PT	BGE2436NT	BGE2436PT	QTY.
	120466-01	Flex Tube	•	•	•	•	1
	100563-01	Warning Plate	•	•	•	•	1
	101054-01	Lighting Instruction Plate	•	•	•	•	1
	100639-12	Caution Decal	•	•	•	•	1
	101137-02	Hardware Kit	•	•	•	•	1
	GA6060	Lava Rock	•	•	•	•	1
	125557-01	Left Ember Chunk #1	•	•	•	•	1
	125557-02	Middle Ember Chunk #2	•	•	•	•	1
	125557-03	Right Ember Chunk #3	•	•	•	•	1
	125071-01	Rockwool Embers	•	•	•	•	1
	125070-01	Platinum Embers	•	•	•	•	1

## PARTS

### THERMOSTATICALLY CONTROLLED MODELS

This list contains replaceable parts used in your heater. When ordering parts, follow the instructions listed under Replacement Parts on page 45 of this manual.

#### KEY

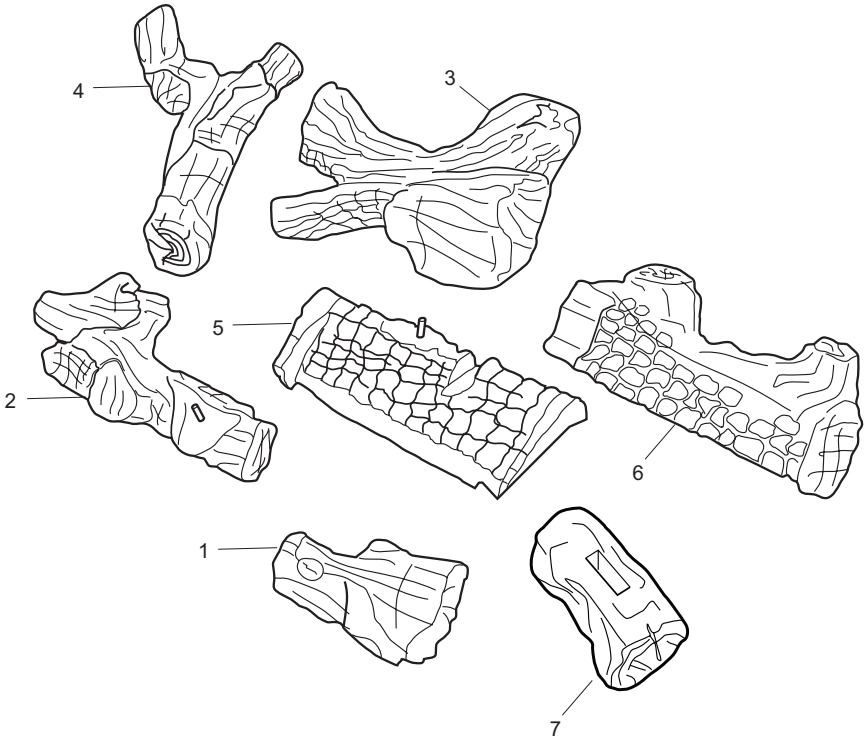
NO.	PART NO.	DESCRIPTION	BGE18NT	BGE18PT	BGE2436NT	BGE2436PT	QTY.
1	098271-12	Cable Ignitor	•	•	•	•	1
2	098544-01	Thermobulb Clip	•	•	•	•	1
3	098867-09	Gas Regulator	•		•		1
	098867-10	Gas Regulator		•		•	1
4	125491-01	Inlet Tube	•	•			1
	125491-02	Inlet Tube			•	•	1
5	101004-06	Front Orifice, 0.0530		•		•	1
	101004-22	Front Orifice, 0.0890			•		1
	101004-04	Front Orifice, 0.0750	•				1
6	101004-09	Rear Orifice, 0.0400		•			1
	101004-01	Rear Orifice, 0.0492				•	1
	101004-14	Rear Orifice, 0.0720			•		1
	101004-11	Rear Orifice, 0.0670	•				1
7	120630-02	Pilot, ODS LP		•		•	1
	120630-05	Pilot, ODS NG	•		•		1
8	101329-20	Gas Valve Service Kit	•				1
	101329-30	Gas Valve Service Kit		•			1
	101329-31	Gas Valve Service Kit			•		1
	101329-26	Gas Valve Service Kit				•	1
9	**	Plate, NG Conversion	•		•		1
10	111435-01	Electronic Ignitor	•	•	•	•	1
11	112465-01	Front Ramp Burner	•	•			1
	112465-02	Front Ramp Burner			•	•	1
12	113242-01	Rear Ramp Burner	•	•			1
	113242-02	Rear Ramp Burner			•	•	1
13	112713-01	Pilot Bracket	•		•		1
	112713-02	Pilot Bracket		•		•	1
14	**	Min. Rate Screw	•	•	•	•	1
15	125489-01	Air Deflector Bracket	•	•			1
	125489-02	Air Deflector Bracket			•	•	1
16							
17	125019-01	Ignitor Bracket	•	•		•	1
18	099211-01	Screw, HWH AB 10-16 x 2.5	•	•	•	•	1
19	125490-01	Manual Valve Bracket	•	•	•	•	1
20	**	Assembly, Ramp Base	•	•	•	•	1
21	121005-01	Air Shield				•	1
22	125499-01	Log Support Bracket			•	•	1
23	120761-01	Log Support Bracket			•	•	1
24	099387-09	Pilot Tube	•	•	•	•	1
25	125491-01	Burner Tube	•	•			1
	125491-02	Burner Tube			•	•	1
26	119321-01	Venturi	•	•	•	•	1
27	119795-01	Gasket	•	•	•	•	1
28	112829-02	Air Shutter	•	•	•	•	1
29	111819-10	Orifice Elbow	•			•	1
	111819-11	Orifice Elbow			•		1
	099056-47	Orifice 0.0225		•			1
30	124933-01	Orifice Holder Elbow		•			1
31	125306-01	Pan Burner	•	•			1
	125306-02	Pan Burner			•	•	1
32	125301-01	Support Bracket	•	•	•	•	2

# PARTS

## LOG MODELS

### LBG18-SM, LBG24-SM, LBG30-SM

This list contains replaceable parts used in your heater. When ordering parts, follow the instructions listed under Replacement Parts on page 45 of this manual.

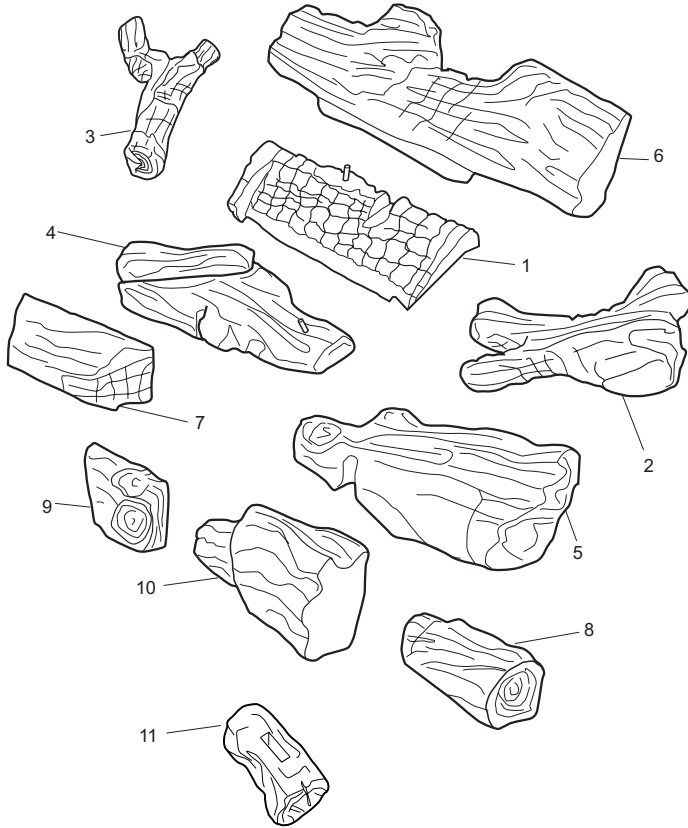


KEY NO.	MODEL NUMBER			DESCRIPTION	QTY
	LBG18-SM	LBG24-SM	LBG30-SM		
1	121699-05	121699-11	121699-17	Front Right Log	1
2	121699-04	121699-10	121699-16	Front Left Log	1
3	121699-02	125683-01	125683-01	Middle Right Log	1
4	121699-03	121699-09	121699-15	Middle Left Log	1
5	121699-01	121699-13	121699-13	Bottom Log (Remote)	1
6	121699-06	121699-12	121699-18	Rear Log	1
7	126080-01	126080-01	126080-01	Switch Log	1

## PARTS

### LOG MODELS LBG36-SM

This list contains replaceable parts used in your heater. When ordering parts, follow the instructions listed under Replacement Parts on page 45 of this manual.

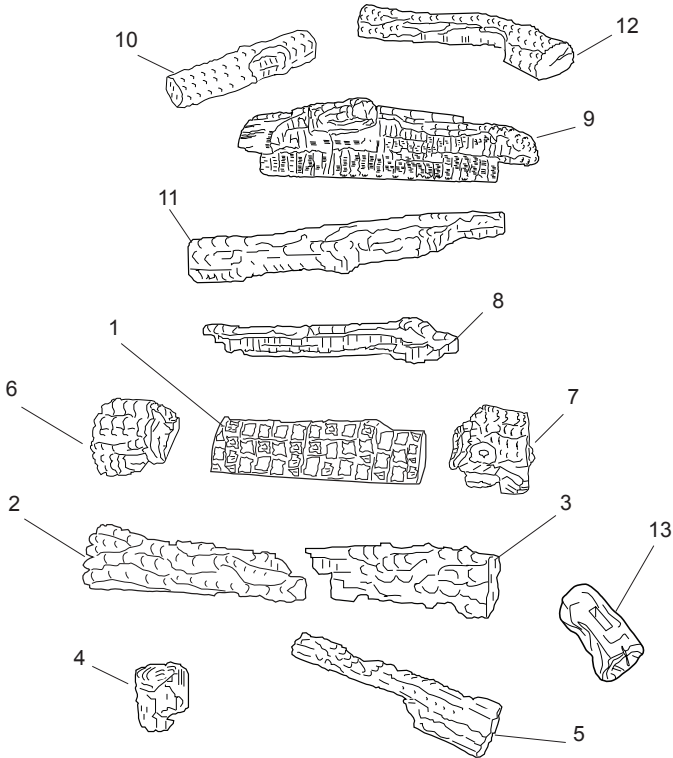


KEY NO.	MODEL NUMBER	DESCRIPTION	QTY
1	121699-13	Bottom Log	1
2	125683-01	Middle Right Log	1
3	121699-15	Middle Left Log	1
4	121699-20	Front Left Log	1
5	121699-21	Front Right Log	1
6	121699-22	Back Log	1
7	121699-23	Left Small Front Log	1
8	121699-24	Right Small Front Log	1
9	121699-25	Left Control Cover Log	1
10	121699-26	Right Control Cover Log	1
11	126080-01	Switch Log	1

## PARTS

### LOG MODELS LBG18-BM, LBG24-BM, LBG30-BM

This list contains replaceable parts used in your heater. When ordering parts, follow the instructions listed under Replacement Parts on page 45 of this manual.



### LOG MODELS LBG18-BM, LBG24-BM, LBG30-BM

Cross reference log numbers.

KEY No.	LBG18-BM	LOG ID No.	LBG24-BM	LOG ID No.	LBG30-BM	LOG ID No.	DESCRIPTION	QTY
1	125851-01	NONE	125852-01	NONE	125852-01	NONE	Log, Ramp	1
2	125851-02	D-064	125852-02	D-057	125853-01	D-038	Log, Left Front	1
3	125851-03	D-065	125852-03	D-058	125853-02	D-039	Log, Right Front	1
4	125851-04	D-073	125852-04	D-048	125852-04	D-048	Log, Left Front Ember Bed	1
5	125851-05	D-072	125852-05	D-047	125852-05	D-047	Log, Right Front Ember Bed	1
6	125851-06	D-066	125852-06	D-040	125852-06	D-040	Log, Left Middle	1
7	125851-07	D-067	125852-07	D-041	125852-07	D-041	Log, Right Middle	1
8	125851-08	D-068	125852-08	D-042	125852-08	D-042	Log, Rear Middle	1
9	125851-09	D-069	125852-09	D-043	125852-09	D-043	Log, Rear	1
10	125851-10	D-046	125851-10	D-046	125851-10	D-046	Log, Left Top	1
11	125851-11	D-070	125852-11	D-044	125852-11	D-044	Log, Middle Crossover	1
12	125851-12	D-071	125852-12	D-045	125852-12	D-045	Log, Top Rear	1
13	121079-01	NONE	121079-01	NONE	121079-01	NONE	Log, LBG-BM Switch	1

## REPLACEMENT PARTS

*Note: Use only original replacement parts. This will protect your warranty coverage for parts replaced under warranty.*

Contact authorized dealers of this product. If they can't supply original replacement part(s), call INNOVATIVE HEARTH PRODUCTS at 1-800-655-2008.

When calling, have ready

- your name
- your address
- model and serial numbers of your heater
- how heater was malfunctioning
- type of gas used (propane/LP or natural gas)
- purchase date

Usually, we will ask you to return the part to the factory.

## SERVICE HINTS

### When Gas Pressure Is Too Low

- pilot will not stay lit
- burners will have delayed ignition
- heater will not produce specified heat
- propane/LP gas supply may be low

You may feel your gas pressure is too low. If so, contact your local propane/LP or natural gas supplier.

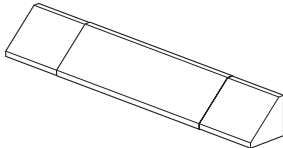
## TECHNICAL SERVICE

You may have further questions about installation, operation or troubleshooting. If so, contact INNOVATIVE HEARTH PRODUCTS at 1-800-655-2008. When calling please have your model and serial numbers of your heater ready.

You can also visit INNOVATIVE HEARTH PRODUCTS technical services web site at [www.IHP.US.com](http://www.IHP.US.com).

## ACCESSORIES

Purchase these heater accessories from your local dealer. If they can not supply these accessories, call INNOVATIVE HEARTH PRODUCTS at 1-800-655-2008 for referral information. You can also write to the address listed on the back page of this manual.



### FIREPLACE HOOD

**Black - GA6050**

**Brushed Brass - GA6053**

**For all models.** Helps deflect heat away from mantel or wall above fireplace. Fits openings 28" to 48" wide.

### LAVA ROCK - GA6060

**For all models.** Order when additional rock is desired.

### VENT-FREE VCT AND VRT FIREBOXES

**Available in 32", 36" and 42" models.**

Flush face and Louver face models available with and without brick.

### FLOOR MEDIA KIT - FM100

**For all models.** Includes lava rock, burner embers, and burner cinders

### CONTROL COVER KIT - CC100

**For all models.** Includes control cover log and 6 unique fall-away logs.

# Innovative Hearth Products Superior™ Brand Gas Log Set Limited Three Year Warranty

## THE WARRANTY

Innovative Hearth Products Limited Three Year Warranty ("IHP") warrants your Superior™ brand Gas Log Set ("Product") to be free from defects in materials and workmanship at the time of manufacture. The logs and grate carry the Limited Three Year Warranty. After installation, if covered components manufactured by IHP are found to be defective in materials or workmanship during the Limited Three Year Warranty period and while the Product remains at the site of the original installation, IHP will, at its option, repair or replace the covered components. If repair or replacement is not commercially practical, IHP will, at its option, refund the purchase price or wholesale price of the IHP product, whichever is applicable. IHP will also pay IHP prevailing labor rates, as determined in its sole discretion, incurred in repairing or replacing such components. THERE ARE EXCLUSIONS AND LIMITATIONS to this Limited Three Year Warranty as described herein.

## COVERAGE COMMENCEMENT DATE

Warranty coverage begins on the date of installation. In the case of new home construction, warranty coverage begins on the date of first occupancy of the dwelling or six months after the sale of the Product by an independent IHP dealer, whichever occurs earlier. The warranty shall commence no later than 24 months following the date of product shipment from IHP, regardless of the installation or occupancy date.

## EXCLUSIONS AND LIMITATIONS

This Limited Three Year Warranty applies only if the Product is installed in the United States or Canada and only if operated and maintained in accordance with the printed instructions accompanying the Product and in compliance with all applicable installation and building codes and good trade practices.

This warranty is non-transferable and extends to the original owner only. The Product must be purchased through a listed supplier of IHP and proof of purchase must be provided. The following do not carry the Limited Three Year Warranty but are warranted as follows:

- Gas components** – Repair or replacement for one year from the date of installation.
- Remote control** – Repair or replacement for one year from the date of installation.
- Labor coverage** – Prevailing IHP labor rates apply for the warranty period of the component.

**Parts not otherwise listed carry a 90 day warranty from the date of installation.**

**Whenever practicable, IHP will provide replacement parts, if available, for a period of 10 years from the last date of manufacture of the product.**

IHP will not be responsible for: (a) damages caused by normal wear and tear, accident, riot, fire, flood or acts of God; (b) damages caused by abuse, negligence, misuse, or unauthorized alteration or repair of the Product affecting its stability or performance (The Product must be subjected to normal use. The Product is designed to burn either natural or propane gas only. Burning conventional fuels such as wood, coal or any other solid fuel will cause damage to the Product, will produce excessive temperatures and could result in a fire hazard.); (c) damages caused by failing to provide proper maintenance and service in accordance with the instructions provided with the Product; (d) damages, repairs or inefficiency resulting from faulty installation or application of the Product.

This Limited Three Year Warranty covers only parts and labor as provided herein. In no case shall IHP be responsible for materials, components or construction which are not manufactured or supplied by IHP or for the labor necessary to install, repair or remove such materials, components or construction. Additional utility bills incurred due to any malfunction or defect in equipment are not covered by this warranty. All replacement or repair components will be shipped F.O.B. from the nearest stocking IHP factory.

## LIMITATION ON LIABILITY

It is expressly agreed and understood that IHP's sole obligation and the purchaser's exclusive remedy under this warranty, under any other warranty, expressed or implied, or in contract, tort or otherwise, shall be limited to replacement, repair, or refund, as specified herein.

In no event shall IHP be liable for any incidental or consequential damages caused by defects in the Product, whether such damage occurs or is discovered before or after replacement or repair, and whether such damage is caused by IHP's negligence. IHP has not made and does not make any representation or warranty of fitness for a particular use or purpose, and there is no implied condition of fitness for a particular use or purpose.

IHP makes no expressed warranties except as stated in this Limited Three Year Warranty. The duration of any implied warranty is limited to the duration of this expressed warranty.

No one is authorized to change this Limited Three Year Warranty or to create for IHP any other obligation or liability in connection with the Product. Some states and provinces do not allow the exclusion or limitation of incidental or consequential damages, so the above limitations or exclusions may not apply to you. The provisions of this Limited Three Year Warranty are in addition to and not a modification of or subtraction from any statutory warranties and other rights and remedies provided by law.

## INVESTIGATION OF CLAIMS AGAINST WARRANTY

IHP reserves the right to investigate any and all claims against this Limited Three Year Warranty and to decide, in its sole discretion, upon the method of settlement.

To receive the benefits and advantages described in this Limited Three Year Warranty, the appliance must be installed and repaired by a licensed contractor approved by IHP.

Contact IHP at the address provided herein to obtain a listing of approved dealers/distributors. **IHP shall in no event be responsible for any warranty work done by a contractor that is not approved without first obtaining IHP's prior written consent.**

## HOW TO REGISTER A CLAIM AGAINST WARRANTY

In order for any claim under this warranty to be valid, you must contact the IHP dealer/distributor from which you purchased the product. If you cannot locate the dealer/distributor, then you must notify IHP in writing. IHP must be notified of the claimed defect in writing within 90 days of the date of failure. Notices should be directed to the IHP Warranty Department at 1508 Elm Hill Pike, Suite 108; Nashville, TN 37210 or visit our website at [WWW.SUPERIORFIREPLACES.US.COM](http://WWW.SUPERIORFIREPLACES.US.COM).

---

---

## **WARRANTY**

---

---

### **KEEP THIS WARRANTY**

Model (located on product or identification tag) \_\_\_\_\_

Serial No. (located on product or identification tag) \_\_\_\_\_

Date Purchased \_\_\_\_\_

Keep receipt for warranty verification.











P126826-01



1508 Elm Hill Pike, Suite 108  
Nashville, TN 37210  
1-800-655-2008  
**www.IHP.US.com**

126826-01  
Rev. A  
01/14