



Installation and Operation Instructions

Superior™ Unvented (Vent-Free) Gas Log Heater

P/N 126857-01 Rev. A 02/2014



P126857-01



Models

VF18NBTB

VF18PBTB

VF24NBTB

VF24PBTB

INSTALLER: Leave this manual with the appliance.

CONSUMER: Retain this manual for future reference.

This appliance may be installed in an aftermarket permanently located, manufactured (mobile) home, where not prohibited by local codes. This appliance is only for use with the type of gas indicated on the rating plate. This appliance is not convertible for use with other gases.

WARNING: This appliance is for installation only in a solid-fuel burning masonry or UL127 factory-built fireplace or in a listed ventless firebox enclosure. It is design-certified for these installations in accordance with ANSI Z21.11.2. Exception: **DO NOT** install this appliance in a factory-built fireplace that includes instructions stating it has not been tested or should not be used with unvented gas logs.

This is an unvented gas-fired heater. It uses air (oxygen) from the room in which it is installed. Provisions for adequate combustion and ventilation air must be provided. Refer to Air for Combustion and Ventilation section on page 6 of this manual.

⚠ WARNING: If the information in these instructions is not followed exactly, a fire or explosion may result causing property damage, personal injury or loss of life.

- Do not store or use gasoline or other flammable vapors and liquids in the vicinity of this or any other appliance.
- **WHAT TO DO IF YOU SMELL GAS:**
 - Do not try to light any appliance.
 - Do not touch any electrical switch; do not use any phone in your building.
 - Immediately call your gas supplier from a neighbor's phone. Follow the gas supplier's instructions.
 - If you cannot reach your gas supplier, call the fire department.
- Installation and service must be performed by a qualified installer, service agency or the gas supplier.

TABLE OF CONTENTS

Safety	2	Cleaning and Maintenance.....	20
Product Identification.....	5	Troubleshooting.....	21
Local Codes.....	5	Specifications	25
Optional Remote Control Accessories.....	5	Wiring Diagram.....	25
Unpacking.....	5	Service Hints	25
Product Features	6	Technical Service.....	25
Air For Combustion and Ventilation.....	6	Replacement Parts.....	25
Installation	8	Parts	26
Operation.....	16	Accessories	28
Inspecting Burners	19	Warranty.....	30

SAFETY

⚠ WARNING: Improper installation, adjustment, alteration, service or maintenance can cause injury or property damage. Refer to this manual for correct installation and operational procedures. For assistance or additional information consult a qualified installer, service agency or the gas supplier.

⚠ WARNING: This appliance is for installation only in a solid-fuel burning masonry or UL127 factory-built fireplace or in a listed ventless firebox enclosure. It is design-certified for these installations in accordance with ANSI Z21.11.2. Exception: DO NOT install this appliance in a factory-built fireplace that includes instructions stating it has not been tested or should not be used with unvented gas logs.

⚠ WARNING: This is an unvented gas-fired heater. It uses air (oxygen) from the room in which it is installed. Provisions for adequate combustion and ventilation air must be provided. Refer to section on page 6 of this manual.

This appliance may be installed in an aftermarket,* permanently located, manufactured (mobile) home, where not prohibited by local codes.

This appliance is only for use with the type of gas indicated on the rating plate. This appliance is not convertible for use with other gases.

* Aftermarket: Completion of sale, not for purpose of resale, from the manufacturer

SAFETY

Continued

⚠ WARNING: This product contains and/or generates chemicals known to the State of California to cause cancer or birth defects or other reproductive harm.

IMPORTANT: Read this owner's manual carefully and completely before trying to assemble, operate or service this heater. Improper use of this heater can cause serious injury or death from burns, fire, explosion, electrical shock and carbon monoxide poisoning.

⚠ DANGER: Carbon monoxide poisoning may lead to death!

Carbon Monoxide Poisoning: Early signs of carbon monoxide poisoning resemble the flu, with headaches, dizziness or nausea. If you have these signs, the fireplace may not be working properly. Get fresh air at once! Have fireplace serviced. Some people are more affected by carbon monoxide than others. These include pregnant women, people with heart or lung disease or anemia, those under the influence of alcohol and those at high altitudes.

Natural and Propane/LP gases: Natural and Propane/LP gases are odorless. An odor-making agent is added to these gases. The odor helps you detect a gas leak. However, the odor added to the gas can fade. Gas may be present even though no odor exists.

Make certain you read and understand all warnings. Keep this manual for reference. It is your guide to safe and proper operation of this fireplace.

⚠ WARNING: Any change to this heater or its controls can be dangerous.

⚠ WARNING: Do not use a blower insert, heat exchanger insert or other accessory not approved for use with this heater.

⚠ WARNING: Vent-free products are prohibited for bedroom and bathroom installation in the Commonwealth of Massachusetts.

⚠ WARNING: Do not allow fans to blow directly into the heater. Avoid any drafts that alter burner flame patterns. Ceiling fans can create drafts that alter burner flame patterns. Altered burner patterns can cause sooting.

⚠ WARNING: Do not place log scraps or lava rocks on burner.

Due to high temperatures, the appliance should be located out of traffic and away from furniture and draperies.

Do not place clothing or other flammable material on or near the appliance. Never place any objects on the heater.

Heater base assembly becomes very hot when running heater. Keep children and adults away from hot surface to avoid burns or clothing ignition. Heater will remain hot for a time after shutdown. Allow surface to cool before touching.

Carefully supervise young children when they are in the room with heater. When using the handheld remote accessory, keep selector switch in the OFF position to prevent children from turning on burners with remote.

SAFETY

You must operate this heater with a fireplace doors or screen in place and fully closed. Unless provided by other means, screens shall have openings for introduction of combustion air.

Keep the appliance area clear and free from combustible materials, gasoline and other flammable vapors and liquids.

1. This appliance is only for use with the type of gas indicated on the rating plate. This appliance is not convertible for use with other gases.
2. Do not place propane/LP supply tank(s) inside any structure. Locate propane/LP supply tank(s) outdoors (propane/LP units only).
3. If you smell gas
 - shut off gas supply
 - do not try to light any appliance
 - do not touch any electrical switch; do not use any phone in your building
 - immediately call your gas supplier from a neighbor's phone. Follow the gas supplier's instructions
 - if you cannot reach your gas supplier, call the fire department
4. This heater shall not be installed in a bedroom or bathroom unless installed as a vented appliance. See *Installing Damper Clamp Accessory for Vented Operation*, page 12.
5. Before installing in a solid fuel burning fireplace, the chimney flue and firebox must be cleaned of soot, creosote, ashes and loose paint by a qualified chimney cleaner. Creosote will ignite if highly heated. A dirty chimney flue may create an distribute soot within the house. Inspect chimney flue for damage. If damaged, repair flue before operating heater.
6. Do not burn solid fuel in a masonry or UL127 factory-built fireplace in which a vent-free room heater is installed.
7. If fireplace has glass doors, never operate this heater with glass doors closed. Any glass door shall be fully opened when the appliance is in operation. If you operate heater with doors closed, heat buildup inside fireplace will cause glass to burst. Make sure there are no obstructions across openings of fireplace.
8. To prevent the creation of soot, follow the instructions in *Cleaning and Maintenance*, page 20.
9. Before using furniture polish, wax, carpet cleaner or similar products, turn heater off. If heated, the vapors from these products may create a white powder residue within burner box or on adjacent walls or furniture.
10. This heater needs fresh, outside air ventilation to run properly. This heater has an oxygen depletion sensing (ODS) pilot light safety system. The ODS shuts down the heater if not enough fresh air is available. See *Air for Combustion and Ventilation*, page 6. If heater keeps shutting off, see *Troubleshooting*, page 21.
11. Do not run heater
 - where flammable liquids or vapors are used or stored
 - under dusty conditions
12. Do not use this heater to cook food or burn paper or other objects.
13. Do not use heater if any part has been exposed to or under water. Immediately call a qualified service technician to inspect the room heater and to replace any part of the control system and any gas control which has been under water.
14. Do not operate heater if any log is broken. Do not operate heater if a log is chipped (dime-sized or larger).
15. Turn heater off and let cool before servicing or repairing. Make sure the selector switch is in the OFF position. Only a qualified service person should install, service or repair heater.
16. Make sure selector switch is in the OFF position when you are away from home for long periods of time.
17. This heater does not need to be connected to any external electrical source.
18. To prevent performance problems, do not use propane/LP fuel tank of less than 100 lb. capacity (propane/LP units only).
19. Provide adequate clearances around air openings.

PRODUCT IDENTIFICATION

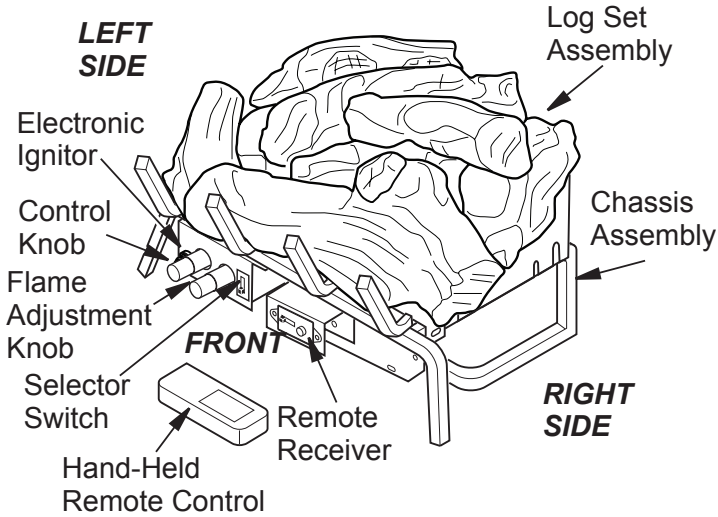

Figure 1 - Product Identification

State of Massachusetts: The installation must be made by a licensed plumber or gas fitter in the Commonwealth of Massachusetts.

Sellers of unvented propane or natural gas-fired supplemental room heaters shall provide to each purchaser a copy of 527 CMR 30 upon sale of the unit.

Vent-free gas products are prohibited for bedroom and bathroom installation in the Commonwealth of Massachusetts.

LOCAL CODES

Install and use heater with care. Follow all local codes. In the absence of local codes, use the latest edition of *The National Fuel Gas Code ANSI Z223.1/NFPA 54**.

*Available from:

American National Standards Institute, Inc.
1430 Broadway
New York, NY 10018

National Fire Protection Association, Inc.
Batterymarch Park
Quincy, MA 02269

REMOTE CONTROL

There are two optional remote accessories that come standard:

- wall switch
- hand-held ON/OFF remote

See [Accessories](#), page 26.

UNPACKING

CAUTION: Do not remove the data plates from the grate assembly. The data plates contain important warranty and safety information.

1. Remove log set assembly from carton. *Note:* Do not pick up assembly by logs. This could damage heater. Always handle assembly by grate.
2. Remove control cover floor media components.
3. Remove all protective packaging applied to log set for shipment.
4. Check heater for any shipping damage. If heater is damaged call INNOVATIVE HEARTH PRODUCTS at 1-800-655-2008 for replacement parts before returning to dealer.

PRODUCT FEATURES

OPERATION

This heater is clean burning. It requires no outside venting. There is no heat loss out a vent or up a chimney. Heat is generated by realistic flames and glowing ceramic logs/coins. This heater is designed for vent-free operation with flue damper closed. It has been tested and approved to ANSI Z21.11.2 standard for unvented heaters. State and local codes in some areas prohibit the use of vent-free heaters. This heater may also be operated as a vented decorative (ANSI Z21.60) product by opening the flue damper.

AIR FOR COMBUSTION AND VENTILATION

⚠ WARNING: This heater shall not be installed in a room or space unless the required volume of indoor combustion air is provided by the method described in the *National Fuel Gas Code, ANSI Z223.1/NFPA 54, the International Fuel Gas Code, or applicable local codes. Read the following instructions to insure proper fresh air for this and other fuel-burning appliances in your home.*

Today's homes are built more energy efficient than ever. New materials, increased insulation and new construction methods help reduce heat loss in homes. Home owners weather strip and caulk around windows and doors to keep the cold air out and the warm air in. During heating months, home owners want their homes as airtight as possible.

While it is good to make your home energy efficient, your home needs to breathe. Fresh air must enter your home. All fuel-burning appliances need fresh air for proper combustion and ventilation.

Exhaust fans, fireplaces, clothes dryers and fuel burning appliances draw air from the house to operate. You must provide adequate fresh air for these appliances. This will insure proper venting of vented fuel-burning appliances.

PROVIDING ADEQUATE VENTILATION

The following are excerpts from *National Fuel Gas Code, ANSI Z223.1/NFPA 54, Air for Combustion and Ventilation*.

SAFETY DEVICE

This heater has a pilot with an Oxygen Depletion Sensing (ODS) safety shutoff system. The ODS/pilot is a required feature for vent-free room heaters. The ODS/pilot shuts off the heater if there is not enough fresh air.

ELECTRONIC IGNITION SYSTEM

This system has an electronic ignitor. This system requires no matches or other sources to light heater. Receiver requires 4 AA batteries (included), hand-held remote control requires a 12-volt battery and a 3-volt button cell battery for the LCD display (both included).

All spaces in homes fall into one of the three following ventilation classifications:

1. Unusually Tight Construction
2. Unconfined Space
3. Confined Space

The information on pages 6 through 8 will help you classify your space and provide adequate ventilation.

Unusually Tight Construction

The air that leaks around doors and windows may provide enough fresh air for combustion and ventilation. However, in buildings of unusually tight construction, you must provide additional fresh air.

Unusually tight construction is defined as construction where:

- a. walls and ceilings exposed to the outside atmosphere have a continuous water vapor retarder with a rating of one perm (6×10^{-11} kg per pa-sec- m^2) or less with openings gasketed or sealed and
- b. weather stripping has been added on openable windows and doors and
- c. caulking or sealants are applied to areas such as joints around window and door frames, between sole plates and floors, between wall-ceiling joints, between wall panels, at penetrations for plumbing, electrical and gas lines and at other openings.

If your home meets all of the three criteria above, you must provide additional fresh air. See *Ventilation Air From Outdoors*, page 8. If your home does not meet all of the three criteria above, proceed to *Determining Fresh-Air Flow For Heater Location*, page 7.

AIR FOR COMBUSTION AND VENTILATION

Continued

Confined and Unconfined Space

The *National Fuel Gas Code, ANSI Z223.1/NFPA 54* defines a confined space as a space whose volume is less than 50 cubic feet per 1,000 Btu per hour (4.8 m³ per kw) of the aggregate input rating of all appliances installed in that space and an unconfined space as a space whose volume is not less than 50 cubic feet per 1,000 Btu per hour (4.8 m³ per kw) of the aggregate input rating of all appliances installed in that space. Rooms communicating directly with the space in which the appliances are installed*, through openings not furnished with doors, are considered a part of the unconfined space.

* Adjoining rooms are communicating only if there are doorless passageways or ventilation grills between them.

DETERMINING FRESH-AIR FLOW FOR HEATER LOCATION

Determining if You Have a Confined or Unconfined Space

Use this work sheet to determine if you have a confined or unconfined space.

Space: Includes the room in which you will install heater plus any adjoining rooms with doorless passageways or ventilation grills between the rooms.

- Determine the volume of the space (length x width x height).

Length x Width x Height = _____ cu. ft. (volume of space)

Example: Space size 20 ft. (length) x 16 ft. (width) x 8 ft. (ceiling height) = 2,560 cu. ft. (volume of space)

If additional ventilation to adjoining room is supplied with grills or openings, add the volume of these rooms to the total volume of the space.

- Multiply the space volume by 20 to determine the maximum Btu/Hr the space can support.

_____ (volume of space) x 20 = (Maximum Btu/Hr the space can support)

Example: 2,560 cu. ft. (volume of space) x 20 = 51,200 (maximum Btu/Hr the space can support)

- Add the Btu/Hr of all fuel burning appliances in the space.

Vent-free fireplace _____ Btu/Hr

Gas water heater* _____ Btu/Hr

Gas furnace _____ Btu/Hr

Vented gas heater _____ Btu/Hr

Gas fireplace logs _____ Btu/Hr

Other gas appliances* + _____ Btu/Hr

Total = _____ Btu/Hr

* Do not include direct-vent gas appliances. Direct-vent draws combustion air from the outdoors and vents to the outdoors.

Example:

Gas water heater	_____	Btu/Hr
Vent-free fireplace	+ _____	Btu/Hr
Total	= _____	Btu/Hr

- Compare the maximum Btu/Hr the space can support with the actual amount of Btu/Hr used.

_____ Btu/Hr (maximum the space can support)

_____ Btu/Hr (actual amount of Btu/Hr used)

Example: 51,200 Btu/Hr (maximum the space can support)

73,000 Btu/Hr (actual amount of Btu/Hr used)

The space in the above example is a confined space because the actual Btu/Hr used is more than the maximum Btu/Hr the space can support. You must provide additional fresh air. Your options are as follows:

- Rework worksheet, adding the space of an adjoining room. If the extra space provides an unconfined space, remove door to adjoining room or add ventilation grills between rooms. See *Ventilation Air From Inside Building*, page 8.
- Vent room directly to the outdoors. See *Ventilation Air From Outdoors*, page 8.
- Install a lower Btu/Hr fireplace, if lower Btu/Hr size makes room unconfined.

If the actual Btu/Hr used is less than the maximum Btu/Hr the space can support, the space is an unconfined space. You will need no additional fresh air ventilation.

⚠ WARNING: If the area in which the heater may be operated does not meet the required volume for indoor combustion air, combustion and ventilation air shall be provided by one of the methods described in the *National Fuel Gas Code, ANSI Z223.1/NFPA 54*, the *International Fuel Gas Code*, or applicable local codes.

AIR FOR COMBUSTION AND VENTILATION

Continued

VENTILATION AIR

Ventilation Air From Inside Building

This fresh air would come from an adjoining unconfined space. When ventilating to an adjoining unconfined space, you must provide two permanent openings: one within 12" of the ceiling and one within 12" of the floor on the wall connecting the two spaces (see options 1 and 2, Figure 2). You can also remove door into adjoining room (see option 3, Figure 2). Follow the *National Fuel Gas Code, ANSI Z223.1/NFPA 54, Air for Combustion and Ventilation* for required size of ventilation grills or ducts.

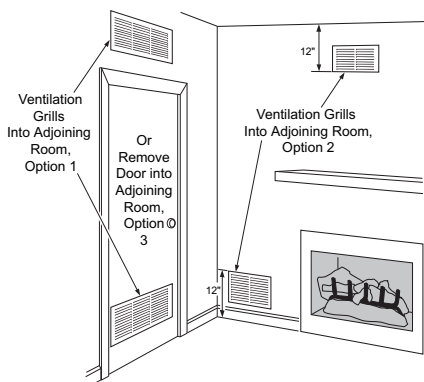

Figure 2 - Ventilation Air from Inside Building

Ventilation Air From Outdoors

Provide extra fresh air by using ventilation grills or ducts. You must provide two permanent openings: one within 12" of the ceiling and one within 12" of the floor. Connect these items directly to the outdoors or spaces open to the outdoors. These spaces include attics and crawl spaces. Follow the *National Fuel Gas Code, ANSI Z223.1/NFPA 54, Air for Combustion and Ventilation* for required size of ventilation grills or ducts.

IMPORTANT: Do not provide openings for inlet or outlet air into attic if attic has a thermostat-controlled power vent. Heated air entering the attic will activate the power vent.

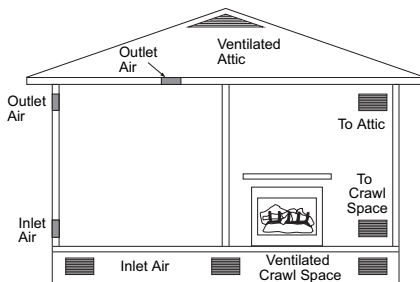

Figure 3 - Ventilation Air from Outdoors

INSTALLATION

NOTICE: This heater is intended for use as supplemental heat. Use this heater along with your primary heating system. Do not install this heater as your primary heat source. If you have a central heating system, you may run system's circulating blower while using heater. This will help circulate the heat throughout the house. In the event of a power outage, you can use this heater as your primary heat source.

WARNING: A qualified service person must install heater. Follow all local codes.

NOTICE: State or local codes may only allow operation of this appliance in a vented configuration. Check your state or local codes.

WARNING: Make sure the selector switch is in the OFF position before installing heater.

WARNING: Seal any fresh air vents or ash clean-out doors located on floor or wall of fireplace. If not, drafting may cause pilot outage or sooting. Use a heat-resistant sealant. Do not seal chimney flue damper.

INSTALLATION

Continued

⚠ WARNING: Before installing in a solid fuel burning fireplace, the chimney flue and firebox must be cleaned of soot, creosote, ashes and loose paint by a qualified chimney cleaner. Creosote will ignite if highly heated. A dirty chimney flue may create and distribute soot within the house. Inspect chimney and firebox flue for damage. If damaged, repair flue and firebox before operating heater.

⚠ WARNING: Never install the heater

- in a bedroom or bathroom unless installed as a vented unit, see page 12
- in a recreational vehicle
- where curtains, furniture, clothing or other flammable objects are less than 42" from the front, top or sides of the heater
- in high traffic areas
- in windy or drafty areas

⚠ CAUTION: This heater creates warm air currents. These currents move heat to wall surfaces next to heater. Installing heater next to vinyl or cloth wall coverings or operating heater where impurities (such as, but not limited to, tobacco smoke, aromatic candles, cleaning fluids, oil or kerosene lamps, etc.) in the air exist, may discolor walls or cause odors.

IMPORTANT: Vent-free heaters add moisture to the air. Although this is beneficial, installing heater in rooms without enough ventilation air may cause mildew to form from too much moisture. See *Air for Combustion and Ventilation*, page 6.

CHECK GAS TYPE

Use correct gas type (natural or propane/LP) for your unit. If your gas supply is not correct, do not install fireplace. Call dealer where you bought fireplace for proper type fireplace.

⚠ WARNING: This appliance is equipped for either natural gas or propane/LP gas but not both. Gas type is indicated on the rating plate. Field conversion is not permitted.

INSTALLATION AND CLEARANCES FOR VENT-FREE OPERATION

⚠ WARNING: Maintain the minimum clearances. If you can, provide greater clearances from floor, ceiling and adjoining wall.

MINIMUM FIREPLACE CLEARANCE TO COMBUSTIBLE MATERIALS

Side Wall 16", Ceiling 42"
Floor 5", Front: 36"

LOG SIZING REQUIREMENTS				
Minimum Firebox Size Center				
Log Size	Height	Depth	Front Width	Rear* Width
18"	17"	14"	24"	20"
24"	17"	14"	28"	22"

*Measured at 14" depth

Carefully follow the instructions below. This will ensure safe installation into a masonry, UL127-listed manufactured fireplace or listed vent-free firebox enclosure.

Minimum Clearances For Side Combustible Material, Side Wall and Ceiling

A. Clearances from the side of the fireplace cabinet to any combustible material and wall should follow diagram in Figure 4, page 10.

Example: The face of a mantel, bookshelf, etc. is made of combustible material and protrudes 3 1/2" from the wall. This combustible material must be 4" from the side of the fireplace cabinet (see Figure 4, page 10).

Any outside air ducts and/or ash dumps in the fireplace shall be permanently closed at the time of appliance installation.

INSTALLATION

Continued

Note: When installing your gas logs into a manufactured firebox, follow firebox manufacturer's instructions for minimum clearances to combustible materials.

- B. Clearances from the top of the fireplace opening to the ceiling should not be less than 42".

NOTICE: Nonthermostat control heaters may be used as a vented product. If so, you must always run heater with chimney flue damper open. If running heater with damper open, noncombustible material above fireplace opening is not needed. Go to Installing Damper Clamp Accessory for Vented Operation, page 12.

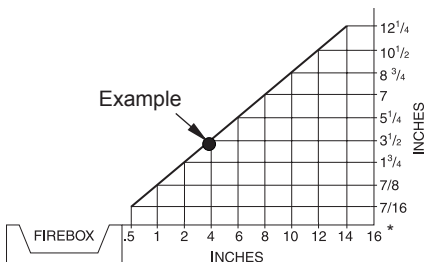

*Minimum 16" from Side Wall

Figure 4 - Minimum Clearance for Combustible to Wall

Minimum Noncombustible Material Clearances

If Not Using Mantel

Note: If using a mantel proceed to If Using Mantel. If not using a mantel, follow these instructions.

You must have noncombustible material(s) above the fireplace opening. Noncombustible materials (such as slate, marble, tile, etc.) must be at least 1/2" thick. With sheet metal, you must have noncombustible material behind it. Noncombustible material must extend at least 8" up (for all models). If noncombustible material is less than 12", you must install the fireplace hood accessory (24" Model Only). See Figure 5 for minimum clearances.

Noncombustible Material Distance (A)	Requirements for Safe Installation
12" or more	Noncombustible material OK.
Between 8" and 12"	24" or 30" Models: Install fireplace hood accessory (GA6050, GA6052 or GA6053 see <u>Accessories</u> , page 26). 18" Model: Noncombustible material OK.
Less than 8"	Noncombustible material must be extended to at least 8". See <u>Between 8" and 12"</u> , above. If you cannot extend material, you must operate heater with flue damper open.

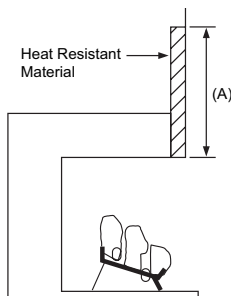

Figure 5 - Heat Resistant Material (Slate, Marble, Tile, etc.) Above Fireplace

If Using Mantel

You must have noncombustible material(s) above the fireplace opening. Noncombustible materials (such as slate, marble, tile, etc.) must be at least 1/2" thick. With sheet metal, you must have noncombustible material behind it. Noncombustible material must extend at least 8" up (for all models). If noncombustible material is less than 12", you must install the fireplace hood accessory (24" Model Only). Even if noncombustible material is more than 12", you may need the hood accessory to deflect heat away from your mantel shelf. See Figure 5 and Figures 6 and 7, page 11, for minimum clearances.

IMPORTANT: If you cannot meet these minimum clearances, you must operate heater with chimney flue damper open. Go to Installing Damper Clamp Accessory for Vented Operation, page 12.

INSTALLATION

Continued

MANTEL CLEARANCES

In addition to meeting noncombustible material clearances, you must also meet required clearances between fireplace opening and mantel shelf. If you do not meet the clearances listed below, you will need a hood.

Determining Minimum Mantel Clearance

If you meet minimum clearance between mantel shelf and top of fireplace opening, a hood is not required (see Figure 6).

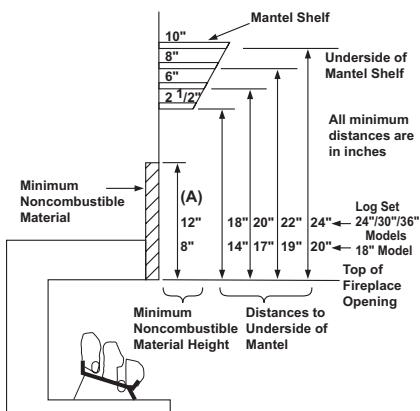

Figure 6 - Minimum Mantel Clearances Without Using Hood

Determining Minimum Mantel Clearance When Using a Hood

If minimum clearances in Figure 6, are not met, you must have a hood. When using a hood there are still certain minimum mantel clearances required. Follow minimum clearances shown in Figure 7, when using hood.

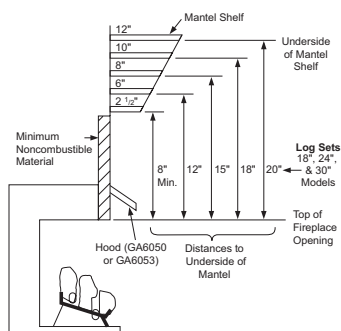

Figure 7 - Minimum Mantel Clearances When Using Hood

NOTICE: Surface temperatures of adjacent walls and mantels become hot during operation. Walls and mantels above the firebox may become hot to the touch. If installed properly, these temperatures meet the requirement of the national product standard. Follow all minimum clearances shown in this manual.

NOTICE: If your installation does not meet the minimum clearances shown, you must do one of the following:

- operate the logs only with the flue damper open
- raise the mantel to an acceptable height
- remove the mantel

FLOOR CLEARANCES

- If installing appliance on the floor level, you must maintain the minimum distance of 14" to combustibles (see Figure 8).
- If combustible materials are less than 14" to the fireplace, you must install appliance at least 5" above the top surface of combustible flooring including tile and carpet (see Figure 9).

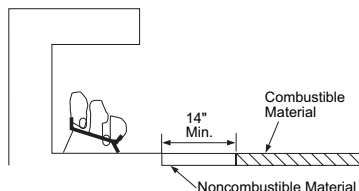

Figure 8 - Minimum Fireplace Clearances If Installed at Floor Level

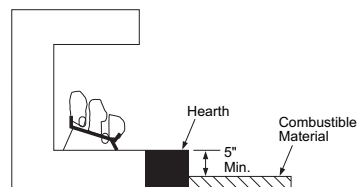

Figure 9 - Minimum Fireplace Clearances Above Combustible Flooring

INSTALLATION

Continued

INSTALLING DAMPER CLAMP ACCESSORY FOR VENTED OPERATION

Note: When used as a vented heater, appliance must be installed only in a solid-fuel burning fireplace with a working flue and constructed of noncombustible material.

For Massachusetts Residents Only: Installation of this gas log set as a vented appliance in the Commonwealth of Massachusetts requires the damper be permanently removed or welded in the fully open position.

If your heater is a non-thermostatically-controlled model, you may use this heater as a vented product. There are three reasons for operating your heater in the vented mode.

1. The fireplace does not meet the clearance to combustibles requirements for vent-free operation.
2. State or local codes do not permit vent-free operation.
3. You prefer vented operation.

If reasons number 1 or 2 above apply to you, you must permanently open chimney flue damper. You must install the damper clamp accessory (to order, see *Accessories*, page 26). This will insure vented operation (see Figure 10). The damper clamp will keep damper open. Installation instructions are included with clamp accessory.

See chart below for minimum permanent flue opening you must provide. Attach damper clamp so the minimum permanent flue opening will be maintained at all times.

Area of Various Standard Round Flues	
Diameter	Area
5"	20 sq. inches
6"	29 sq. inches
7"	39 sq. inches
8"	51 sq. inches

Chimney Height	Minimum Permanent Flue Opening
6' to 15'	39 sq. inches
15' to 30'	29 sq. inches

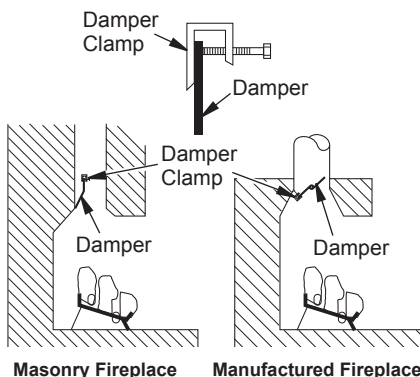

Figure 10 - Attaching Damper Clamp

INSTALLING HEATER BASE ASSEMBLY

⚠ WARNING: You must secure this heater to fireplace floor. If not, heater will move when you adjust controls. Moving heater may cause a gas leak.

⚠ WARNING: If installing in a sunken fireplace, special care is needed. You must raise the fireplace floor to allow access to heater control panel. This will insure adequate air flow and guard against sooting and controls being damaged. Raise fireplace floor with noncombustible material. Make sure material is secure.

⚠ CAUTION: Do not pick up heater base assembly by burners. This could damage heater. Only handle base assembly by grates.

IMPORTANT: Make sure the heater burners are level.

INSTALLATION

Continued

Installation Items Needed

- control cover kit (provided with heater)
- approved flexible gas hose (provided) (if allowed by local codes)
- sealant (resistant to propane/LP gas, not provided)
- pipe wrench

Note: Install optional remote control accessories (see Accessories, page 26) before installing gas log heater.

1. Apply pipe joint sealant lightly to male threads of gas fitting (not provided). Connect approved flexible gas hose to inlet side of gas control (see Figure 11). **IMPORTANT:** Hold gas fitting with wrench when connecting flexible gas hose.
2. Position heater assembly in fireplace.
3. Connect to gas supply. See Connecting to Gas Supply.

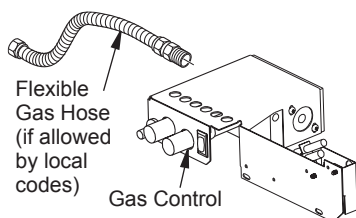

Figure 11 - Attaching Flexible Gas Hose to Heater Gas Regulator

CONNECTING TO GAS SUPPLY

WARNING: This appliance requires a 3/8" NPT (National Pipe Thread) inlet connection to the pressure regulator.

WARNING: A qualified service person must connect heater to gas supply. Follow all local codes.

CAUTION: Never connect propane/LP fireplace directly to the propane/LP supply. This heater requires an external regulator (not supplied). Install the external regulator between the heater and propane/LP supply.

WARNING: Never connect natural gas fireplace to private (non-utility) gas wells. This gas is commonly known as wellhead gas.

Installation Items Needed

Before installing heater, make sure you have the items listed below.

- external regulator (for propane/LP units only, supplied by installer)
- piping (check local codes)
- sealant (resistant to propane/LP gas)
- equipment shutoff valve *
- test gauge connection *
- sediment trap
- tee joint
- pipe wrench
- approved flexible gas line with gas connector (if allowed by local codes) (provided)

* A CSA design-certified equipment shutoff valve with 1/8" NPT tap is an acceptable alternative to test gauge connection. Purchase the optional CSA design-certified equipment shutoff valve from your dealer.

For propane/LP units, the installer must supply an external regulator. The external regulator will reduce incoming gas pressure. You must reduce incoming gas pressure to between 11" and 14" of water. If you do not reduce incoming gas pressure, heater regulator damage could occur. Install external regulator with the vent pointing down as shown in Figure 12. Pointing the vent down protects it from freezing rain or sleet.

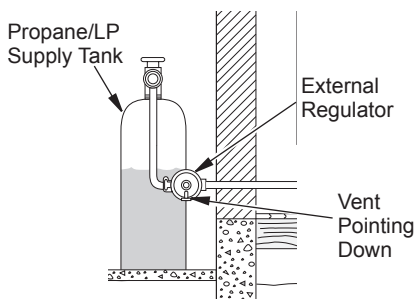

Figure 12 - External Regulator With Vent Pointing Down

INSTALLATION

Continued

⚠ CAUTION: Use only new, black iron or steel pipe. Internally-tinned copper tubing may be used in certain areas. Check your local codes. Use pipe of 1/2" diameter or greater to allow proper gas volume to heater. If pipe is too small, undue loss of volume will occur.

Installation must include an equipment shutoff valve, union and plugged 1/8" NPT tap. Locate NPT tap within reach for test gauge hook up. NPT tap must be upstream from heater (see Figure 13).

IMPORTANT: Install equipment shutoff valve in an accessible location. The equipment shutoff valve is for turning on or shutting off the gas to the appliance.

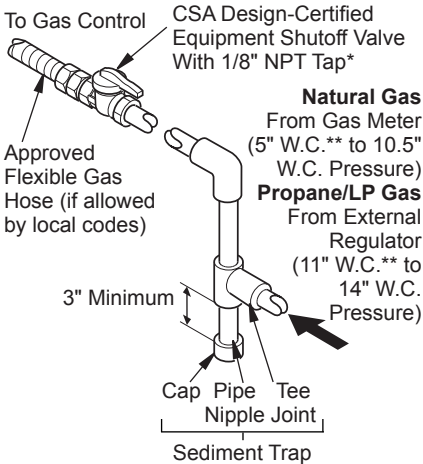

Figure 13 - Gas Connection

* Purchase the optional CSA design-certified equipment shutoff valve from your dealer.

** Minimum inlet pressure for purpose of input adjustment.

Check your building codes for any special requirements for locating equipment shutoff valve to fireplaces.

Apply pipe joint sealant lightly to male NPT threads. This will prevent excess sealant from going into pipe. Excess sealant in pipe could result in clogged heater valves.

⚠ WARNING: Use pipe joint sealant that is resistant to liquid petroleum (LP) gas.

We recommend that you install a sediment trap (not supplied with log set) in supply line as shown in Figure 13. Locate sediment trap where it is within reach for cleaning. Install in piping system between fuel supply and heater. Locate sediment trap where trapped matter is not likely to freeze. A sediment trap captures moisture and contaminants. This keeps them from going into heater controls. If sediment trap is not installed or is installed wrong, heater may not run properly.

⚠ CAUTION: Avoid damage to gas control. Hold gas control with wrench when connecting it to gas piping and/or fittings.

CHECKING GAS CONNECTIONS

⚠ WARNING: Test all gas piping and connections, internal and external to unit, for leaks after installing or servicing. Correct all leaks at once.

⚠ WARNING: Never use an open flame to check for a leak. Apply a noncorrosive leak detection fluid to all joints. Bubbles forming show a leak. Correct all leaks at once.

⚠ CAUTION: Make sure external regulator has been installed between propane/LP supply and heater. See guidelines under Connecting to Gas Supply, page 13.

INSTALLATION

Continued

PRESSURE TESTING GAS SUPPLY PIPING SYSTEM

Test Pressures In Excess Of 1/2 PSIG (3.5 kPa)

1. Disconnect appliance with its appliance main gas valve (control valve) and equipment shutoff valve from gas supply piping system. Pressures in excess of 1/2 psig (3.5 kPa) will damage heater regulator.
2. Cap off open end of gas pipe where equipment shutoff valve was connected.
3. Pressurize supply piping system by either opening propane/LP supply tank valve for propane/LP gas or opening main gas valve located on or near gas meter for natural gas or using compressed air.
4. Check all joints of gas supply piping system. Apply noncorrosive leak detection fluid to all joints. Bubbles forming show a leak.
5. Correct all leaks at once.
6. Reconnect heater and equipment shutoff valve to gas supply. Check reconnected fittings for leaks.

Test Pressures Equal To or Less Than 1/2 PSIG (3.5 kPa)

1. Close equipment shutoff valve (see Figure 14).
2. Pressurize supply piping system by either opening propane/LP supply tank valve for propane/LP gas or opening main gas valve located on or near gas meter for natural gas or using compressed air.
3. Check all joints from gas meter to equipment shutoff valve for natural gas or propane/LP supply to equipment shutoff valve for propane/LP (see Figure 15 or 16). Apply noncorrosive leak detection fluid to all joints. Bubbles forming show a leak.
4. Correct all leaks at once.

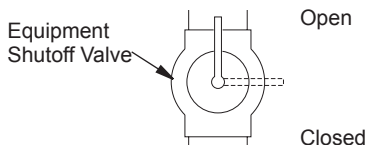

Figure 14 - Equipment Shutoff Valve

PRESSURE TESTING HEATER GAS CONNECTIONS

1. Open equipment shutoff valve (see Figure 14).
2. Open main gas valve located on or near gas meter for natural gas or open propane/LP supply tank valve.
3. Make sure control knob of heater is in the OFF position.
4. Check all joints from equipment shutoff valve to control valve (see Figure 15 or 16). Apply noncorrosive leak detection fluid to all joints. Bubbles forming show a leak.
5. Correct all leaks at once.
6. Light heater (see *Operation*, page 16). Check all other internal joints for leaks.
7. Turn off heater (see *To Turn Off Gas to Appliance*, page 17).

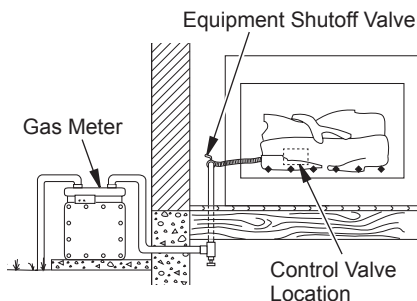

Figure 15 - Checking Gas Joints for Natural Gas

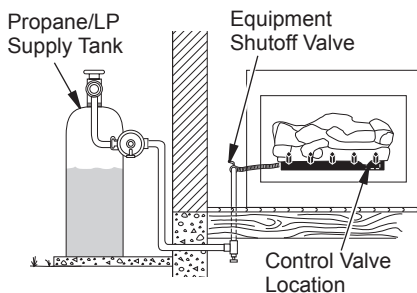

Figure 16 - Checking Gas Joints (Propane/LP Only)

OPERATION

FOR YOUR SAFETY READ BEFORE LIGHTING

⚠ WARNING: If you do not follow these instructions exactly, a fire or explosion may result causing property damage, personal injury or loss of life.

- A. This appliance has a pilot which must be lighted by hand. When lighting the pilot, follow these instructions exactly.
- B. **BEFORE LIGHTING** smell all around the appliance area for gas. Be sure to smell next to the floor because some gas is heavier than air and will settle on the floor.

WHAT TO DO IF YOU SMELL GAS

- Do not try to light any appliance.
 - Do not touch any electric switch; do not use any phone in your building.
 - Immediately call your gas supplier from a neighbor's phone. Follow the gas supplier's instructions.
 - If you cannot reach your gas supplier, call the fire department.
- C. Use only your hand to push in or turn the gas control knob. Never use tools. If the knob will not push in or turn by hand, don't try to repair it, call a qualified service technician or gas supplier. Force or attempted repair may result in a fire or explosion.
 - D. Do not use this appliance if any part has been under water. Immediately call a qualified service technician to inspect the appliance and to replace any part of the control system and any gas control which has been under water.

LIGHTING INSTRUCTIONS

- ⚠ WARNING:**
- If fireplace has glass doors, never operate this heater with glass doors closed. If you operate heater with doors closed, heat buildup inside fireplace will cause glass to burst. Make sure there are no obstructions across openings of fireplace.
 - You must operate this heater with a fireplace screen in place. Make sure fireplace screen is closed before running heater.

NOTICE: During initial operation of new heater, burning logs will give off a paper-burning smell. Orange flame will also be present. Open damper or window to vent smell. This will only last a few hours.

NOTICE: During initial operation of new heater, metallic components may emit an odor as paint and assembly compounds are heated and cure. Be sure to provide adequate fresh air if odors are detected.

Note: Home owners generally prefer to operate their heater with the chimney damper closed. This will put all the heat into the room. However, there may be times you will desire the full flames of the HI heat setting but will find the heat output excessive. You can open the chimney damper (if you have one) fully or partially to release some of the heat.

⚠ WARNING: Damper handle will be hot if heater has been running.

OPERATION

Continued

1. STOP! Read the safety information on page 16.
2. Make sure equipment shutoff valve is fully open.
3. Set selector switch in the OFF position.
4. Press in and turn control knob clockwise ↻ to the OFF position see Figure 17.
9. Slightly push in and turn control knob counterclockwise ↻ to the ON position.
10. Wait one minute and switch selector switch to the ON position to light burners.
11. Set flame adjustment knob to any level between HI and LO.

⚠ WARNING: Burners will come on automatically within one minute when the selector switch is in the ON position after the pilot is lit.

5. Wait five (5) minutes to clear out any gas. Then smell for gas, including near the floor. If you smell gas, STOP! Follow "B" in the safety information, page 15. If you don't smell gas, go to the next step.
6. Press in and turn control knob counterclockwise ↻ to the PILOT position. Press in control knob for five (5) seconds see Figure 17.

Note: You may be running this heater for the first time after hooking up to gas supply. If so, the control knob may need to be pressed in for 30 seconds or more. This will allow air to bleed from the gas system.

7. With control knob pressed in, press ignitor button. This will light pilot. The pilot is attached to the front burner. If needed, keep pressing ignitor button until pilot lights.

Note: If pilot does not stay lit, contact a qualified service person or gas supplier for repairs. Until repairs are made, light pilot with match. To light pilot with match, see Manual Lighting Procedure, page 18.

8. Keep control knob pressed in for 30 seconds after lighting pilot. After 30 seconds, release control knob.

• If control knob does not pop out when released, contact a qualified service person or gas supplier for repairs.

Note: If pilot goes out, repeat steps 4 through 8.

12. To leave pilot lit and shut off burners only, turn control knob clockwise to the PILOT position, use remote control manual OFF button, then set selector switch in the OFF position.

⚠ CAUTION: Do not try to adjust heating levels by using the equipment shutoff valve.

⚠ WARNING: Make sure selector switch is in to OFF position when you are away from home for long periods of time. Appliance will come on automatically with selector switch in the ON position.

TO TURN OFF GAS TO APPLIANCE

Shutting Off Heater

1. Turn control knob clockwise ↻ to the OFF position.
- 2a. Set selector switch in the OFF position.
- 2b. If Using Optional Hand-Held Remote: Set selector switch in the OFF position to prevent draining battery.
3. Close equipment shut off valve (see Figure 14, page 15).

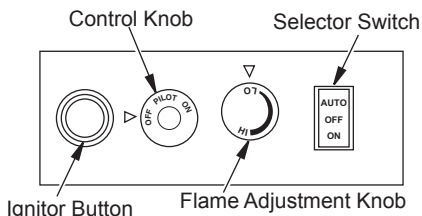

Figure 17 - Control Knob and Ignitor Button Locations

OPERATION

Continued

MANUAL LIGHTING PROCEDURE

1. Follow steps 1 through 6 under Lighting Instructions, page 16.
2. Depress control knob and light pilot with match.
3. Keep control knob pressed in for 30 seconds after lighting pilot. After 30 seconds, release control knob. Now follow steps 9 through 11, Lighting Instructions, page 17.

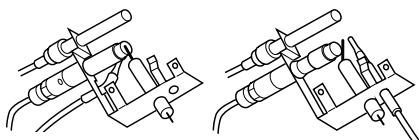

Propane/LP

Natural

Figure 18 - Pilot (Remote Shown)

REMOTE CONTROL OPERATION - OPTIONAL

1. After lighting, let pilot flame burn for about one minute. Turn control knob to ON position. Adjust flame adjustment knob anywhere between HI and LO. Set toggle selector switch to AUTO. Slide remote selector switch to REMOTE position (see Figure 19). *Note: The burner may light if hand-held remote was on when selector switch was last turned off. You can now turn burner on and off with hand-held remote control unit.*

IMPORTANT: Do not leave the selector switch in the REMOTE or ON position when the pilot is not lit. This will drain the battery.

2. Press ON/OFF button to turn burners on and off. When turning burners off, the pilot will remain lit.

IMPORTANT: Be sure to press ON/OFF buttons on hand-held remote control unit for up to 3 seconds to assure proper operation.

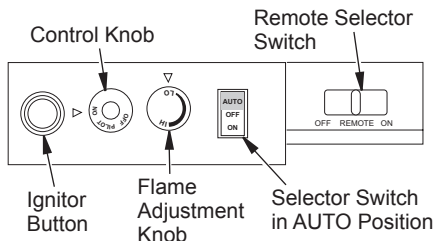

Figure 19 - Control Knob and Ignitor Button Locations for Remote Control

Remote Control Specifications

Batteries: (See instructions with remote for removing and installing batteries)

Transmitter requires 12V (A-23) and 3V button cell for LCD (both included)

Remote receiver requires 4 AA (1.5V) alkaline batteries (included)

Operating Frequency: 303.875 MHz

INSPECTING BURNERS

Check pilot flame pattern and burner flame patterns often.

PILOT FLAME PATTERN

Figure 20 shows a correct pilot flame pattern. Figure 21 shows an incorrect pilot flame pattern. The incorrect pilot flame is not touching the thermocouple. When the thermocouple cools, the heater will shut down.

If pilot flame pattern is incorrect, as shown in Figure 21

- turn heater off (see [To Turn Off Gas to Appliance](#), above or page 17)
- see [Troubleshooting](#), page 21

Note: The pilot flame on natural gas units will have a slight curve, but flame should be blue and have no yellow or orange color.

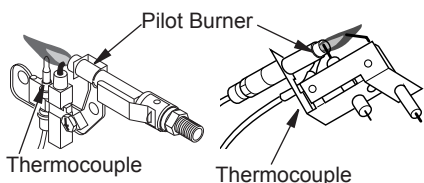

Figure 20 - Correct Pilot Flame Pattern (Your Pilot May Differ from Pilots Shown)

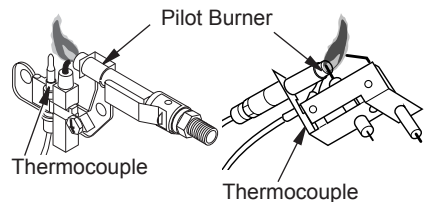

Figure 21 - Incorrect Pilot Flame Pattern (Your Pilot May Differ from Pilots Shown)

BURNER FLAME PATTERN

Figure 22 shows correct burner flame pattern.

NOTICE: Do not mistake orange flames with yellow tipping. Dirt or other fine particles are burned by heater, causing brief patches of orange flame.

If burner flame pattern is incorrect, as shown in Figure 23

- turn appliance off (see [To Turn Off Gas to Appliance](#), page 17)
- see [Troubleshooting](#), page 21

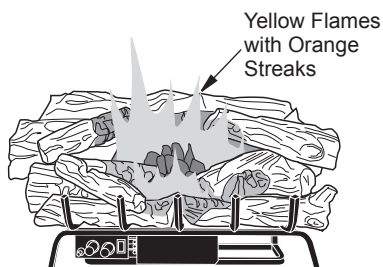

Figure 22 - Correct Burner Flame Pattern

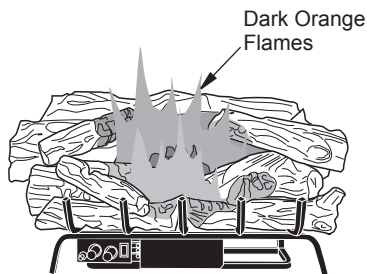

Figure 23 - Incorrect Burner Flame Pattern

CLEANING AND MAINTENANCE

⚠ WARNING: Turn off heater and let cool before cleaning.

⚠ CAUTION: You must keep control areas, burner and circulating air passageways of heater clean. Inspect these areas of heater before each use. Have heater inspected yearly by a qualified service person. Heater may need more frequent cleaning due to excessive lint from carpeting, bedding material, pet hair, etc.

⚠ WARNING: Failure to keep the primary air opening(s) of the burner(s) clean may result in sooting and property damage.

BURNER INJECTOR HOLDER AND PILOT AIR INLET HOLE

The primary air inlet holes allow the proper amount of air to mix with the gas. This provides a clean burning flame. Keep these holes clear of dust, dirt, lint and pet hair. Clean these air inlet holes prior to each heating season. Blocked air holes will create soot. We recommend that you clean the unit every three months during operation and have heater inspected yearly by a qualified service person.

We also recommend that you keep the burner tube clean and free of dust and dirt. We recommend using compressed air no greater than 30 PSI. Your local computer store, hardware store or home center may carry compressed air in a can. If using compressed air in a can, please follow the directions on the can. If you don't follow directions on the can, you could damage the pilot assembly.

1. Shut off the unit, including the pilot. Allow the unit to cool for at least thirty minutes.
2. Inspect burner and primary air inlet holes on injector holder for dust and dirt (see Figure 24 and 25).
3. Blow air through the ports/slots and holes in the burner.

4. Check the injector holder located at the end of the burner tube again. Remove any large particles of dust, dirt, lint or pet hair with a soft cloth or vacuum cleaner nozzle.
5. Blow air into the primary air holes on the injector holder.
6. In case any large clumps of dust have now been pushed into the burner repeat steps 2 and 3.

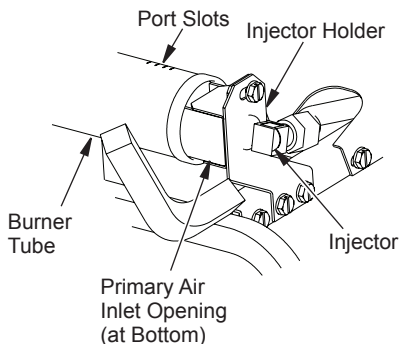

Figure 24 - Injector Holder on Outlet Burner Tube

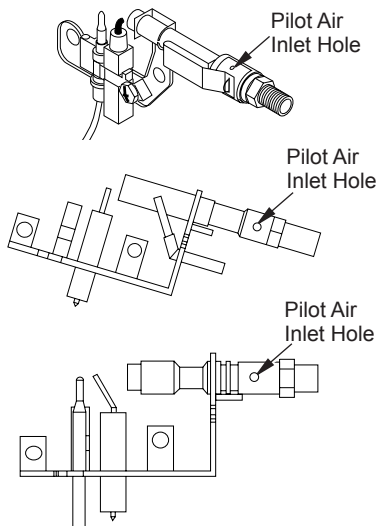

Figure 25 - Pilot Air Inlet Hole (Your Pilot May Differ from Pilots Shown)

TROUBLESHOOTING

⚠ WARNING: Turn off heater and let cool before servicing. Only a qualified service person should service and repair heater.

⚠ CAUTION: Never use a wire, needle or similar object to clean ODS/pilot. This can damage ODS/pilot unit.

Note: All troubleshooting items are listed in order of operation.

OBSERVED PROBLEM	POSSIBLE CAUSE	REMEDY
When ignitor button is pressed, there is no spark at ODS/pilot	<ol style="list-style-type: none"> 1. Ignitor electrode not connected to ignitor cable 2. Ignitor cable pinched or wet 3. Electronic ignitor battery is weak 4. Broken ignitor cable 5. Bad electronic ignitor 6. Ignitor electrode positioned wrong or broken 	<ol style="list-style-type: none"> 1. Reconnect ignitor cable 2. Free ignitor cable if pinched by any metal or tubing. Keep ignitor cable dry 3. Replace battery 4. Replace ignitor cable 5. Replace electronic ignitor 6. Replace pilot assembly
When ignitor button is pressed, there is spark at ODS/pilot but no ignition	<ol style="list-style-type: none"> 1. Gas supply turned off or equipment shutoff valve closed 2. Control knob not in PILOT position 3. Control knob not pressed in while in PILOT position 4. Air in gas lines when installed 5. Depleted gas supply (propane/LP only) 6. ODS/pilot is clogged 7. Gas regulator setting is not correct 	<ol style="list-style-type: none"> 1. Turn on gas supply or open equipment shutoff valve 2. Turn control knob to PILOT position 3. Press in control knob while in PILOT position 4. Continue holding down control knob. Repeat igniting operation until air is removed 5. Contact local propane/LP gas company 6. Clean ODS/pilot (see <i>Cleaning and Maintenance</i>, page 20) or replace ODS/pilot assembly 7. Replace gas regulator

TROUBLESHOOTING

Continued

OBSERVED PROBLEM	POSSIBLE CAUSE	REMEDY
ODS/pilot lights but flame goes out when control knob is released	<ol style="list-style-type: none"> 1. Control knob not fully pressed in 2. Control knob not pressed in long enough 3. Safety interlock system has been triggered 4. Equipment shutoff valve not fully open 5. Pilot flame not touching thermocouple, which allows thermocouple to cool, causing pilot flame to go out. This problem could be caused by one or both of the following: A) Low gas pressure B) Dirty or partially clogged ODS/pilot 6. Thermocouple connection loose at control valve 7. Thermocouple damaged 8. Control valve damaged 	<ol style="list-style-type: none"> 1. Press in control knob fully 2. After ODS/pilot lights, keep control knob pressed in 30 seconds 3. Wait one minute for safety interlock system to reset. Repeat ignition operation 4. Fully open equipment shutoff valve 5. A) Contact local natural or propane/LP gas company B) Clean ODS/pilot (see <u><i>Cleaning and Maintenance</i></u>, page 20) or replace ODS/pilot assembly 6. Hand tighten until snug, then tighten 1/4 turn more 7. Replace pilot assembly 8. Replace control valve
Burner does not light after ODS/pilot is lit	<ol style="list-style-type: none"> 1. Inlet gas pressure is too low 2. Burner orifice clogged 3. Mislocated crossover tube 4. Remote selector in OFF position 5. Wire disconnected from gas control 	<ol style="list-style-type: none"> 1. Contact local natural or propane/LP gas company 2. Clean burner (see <u><i>Cleaning and Maintenance</i></u>, page 20) or replace burner orifice 3. Contact qualified service person 4. Put remote selector in ON position 5. See <u><i>Wiring Diagram</i></u>, page 25 control
Delayed ignition of burner	<ol style="list-style-type: none"> 1. Manifold pressure is too low 2. Burner orifice clogged 3. Mislocated crossover tube 	<ol style="list-style-type: none"> 1. Contact local natural or propane/LP gas company 2. Clean burner (see <u><i>Cleaning and Maintenance</i></u>, page 20) or replace burner orifice 3. Contact qualified service person
Burner backfiring during combustion	<ol style="list-style-type: none"> 1. Burner orifice is clogged or damaged 2. Damaged burner 3. Gas regulator defective 	<ol style="list-style-type: none"> 1. Clean burner (see <u><i>Cleaning and Maintenance</i></u>, page 20) or replace burner orifice 2. Replace damaged burner 3. Replace gas regulator

TROUBLESHOOTING

Continued

OBSERVED PROBLEM	POSSIBLE CAUSE	REMEDY
Orange flame in burner during burner combustion	<ol style="list-style-type: none"> 1. Not enough air 2. Gas regulator defective 	<ol style="list-style-type: none"> 1. Check burner for dirt and debris. If found, clean burner (see <i>Cleaning and Maintenance</i>, page 20) 2. Replace gas regulator
Slight smoke or odor during initial operation	<ol style="list-style-type: none"> 1. Residues from manufacturing processes and logs curing 	<ol style="list-style-type: none"> 1. Problem will stop after a few hours of operation
Heater produces a whistling noise when burner is lit	<ol style="list-style-type: none"> 1. Turning control knob to HI position when burner is cold 2. Air in gas line 3. Air passageways on heater blocked 4. Dirty or partially clogged burner orifice 	<ol style="list-style-type: none"> 1. Turn control knob to LO position and let warm up for a minute 2. Operate burner until air is removed from line. Have gas line checked by local natural or propane/LP gas company 3. Observe minimum installation clearances (see pages 9 through 11) 4. Clean burner (see <i>Cleaning and Maintenance</i>, page 20) or replace burner orifice
White powder residue forming within burner box or on adjacent walls or furniture	<ol style="list-style-type: none"> 1. When heated, vapors from furniture polish, wax, carpet cleaners, etc. may turn into white powder residue 	<ol style="list-style-type: none"> 1. Turn heater off when using furniture polish, wax, carpet cleaners, or similar products
Moisture/condensation noticed on windows	<ol style="list-style-type: none"> 1. Not enough combustion/ventilation air 	<ol style="list-style-type: none"> 1. Refer to <i>Air for Combustion and Ventilation</i> requirements (page 6)
Remote does not function	<ol style="list-style-type: none"> 1. Battery is not installed. Battery power is low 	<ol style="list-style-type: none"> 1. Replace batteries in receiver and hand-held remote control
Heater produces a clicking/ticking noise just after burners are lit or shut off	<ol style="list-style-type: none"> 1. Metal expanding while heating or contracting while cooling 	<ol style="list-style-type: none"> 1. This is normal with most heaters. If noise is excessive, contact qualified service person

TROUBLESHOOTING

Continued



WARNING: If you smell gas

- Shut off gas supply.
- Do not try to light any appliance.
- Do not touch any electrical switch; do not use any phone in your building.
- Immediately call your gas supplier from a neighbor's phone. Follow the gas supplier's instructions.
- If you cannot reach your gas supplier, call the fire department.

IMPORTANT: Operating heater where impurities in air exist may create odors. Cleaning supplies, paint, paint remover, cigarette smoke, cements and glues, new carpet or textiles, etc., create fumes. These fumes may mix with combustion air and create odors. These odors will disappear over time.

OBSERVED PROBLEM	POSSIBLE CAUSE	REMEDY
Heater produces unwanted odors	<ol style="list-style-type: none">1. Heater burning vapors from paint, hair spray, glues, cleaners, chemicals, new carpet, etc. (See <i>IMPORTANT</i> statement above)2. Low fuel supply (propane/LP only)3. Gas leak. See Warning statement at top of page	<ol style="list-style-type: none">1. Open window to ventilate room. Stop using odor causing products while heater is running2. Refill supply tank (propane/LP only)3. Locate and correct all leaks (see <u><i>Checking Gas Connections</i></u>, page 14)
Heater shuts off in use (ODS operates)	<ol style="list-style-type: none">1. Not enough fresh air is available2. Low line pressure3. ODS/pilot is partially clogged	<ol style="list-style-type: none">1. Open window and/or door for ventilation2. Contact local natural or propane/LP gas company3. Clean ODS/pilot (see <u><i>Cleaning and Maintenance</i></u>, page 20)
Gas odor even when control knob is in OFF position	<ol style="list-style-type: none">1. Gas leak. See Warning statement at top of page2. Control valve or gas control defective	<ol style="list-style-type: none">1. Locate and correct all leaks (see <u><i>Checking Gas Connections</i></u>, page 14)2. Replace control valve or gas control
Gas odor during combustion	<ol style="list-style-type: none">1. Foreign matter between control valve and burner2. Gas leak. See Warning statement at top of page	<ol style="list-style-type: none">1. Take apart gas tubing and remove foreign matter2. Locate and correct all leaks (see <u><i>Checking Gas Connections</i></u>, page 14)

SPECIFICATIONS

Model VF18NBTB

- Input Rating: 24,000/36,000 Btu/Hr
- Fuel: Natural Gas
- Ignition: Electronic
- Manifold Pressure: 3.5" W.C.
- Inlet Gas Pressure (in. of water):
Max. - 10.5" W.C, Min. - 5.0 W.C *
- Shipping Weight: 32 lbs.

Model VF18PBTB

- Input Rating: 24,000/36,000 Btu/Hr
- Fuel: Propane/LP Gas
- Ignition: Electronic
- Manifold Pressure: 10" W.C.
- Inlet Gas Pressure (in. of water):
Max.- 14" W.C, Min. - 11" W.C *
- Shipping Weight: 32 lbs.

Model VF24NBTB

- Input Rating: 25,000/39,000 Btu/Hr
- Fuel: Natural Gas
- Ignition: Electronic
- Manifold Pressure: 3.5" W.C.
- Inlet Gas Pressure (in. of water):
Max. - 10.5" W.C, Min. - 5.0 W.C *
- Shipping Weight: 34 lbs.

Model VF24PBTB

- Input Rating: 25,000/39,000 Btu/Hr
- Fuel: Propane/LP Gas
- Ignition: Electronic
- Manifold Pressure: 10" W.C.
- Inlet Gas Pressure (in. of water):
Max. - 14" W.C, Min. - 11" W.C *
- Shipping Weight: 34 lbs.

* For purpose of input adjustment

WIRING DIAGRAM

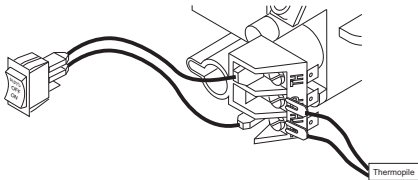

SERVICE HINTS

When Gas Pressure Is Too Low

- pilot will not stay lit
- burners will have delayed ignition
- heater will not produce specified heat
- (for propane/LP units) propane/LP gas supply may be low

You may feel your gas pressure is too low. If so, contact your local propane/LP or natural gas supplier.

TECHNICAL SERVICE

You may have further questions about installation, operation, or troubleshooting. If so, contact INNOVATIVE HEARTH PRODUCTS at 1-800-655-2008. When calling please have your model and serial numbers of your heater ready.

You can also visit our web site at www.IHP.US.com.

REPLACEMENT PARTS

Note: Use only original replacement parts. This will protect your warranty coverage for parts replaced under warranty.

PARTS UNDER WARRANTY

Contact authorized dealers of this product. If they can't supply original replacement part(s), call INNOVATIVE HEARTH PRODUCTS at 1-800-655-2008.

When calling, have ready:

- your name
- your address
- model and serial numbers of your appliance
- how appliance was malfunctioning
- type of gas used (propane/LP or natural gas)
- purchase date

Usually, we will ask you to return the part to the factory.

PARTS

MODELS VF18NBTB, VF18PBTB, VF24NBTB AND VF24PBTB

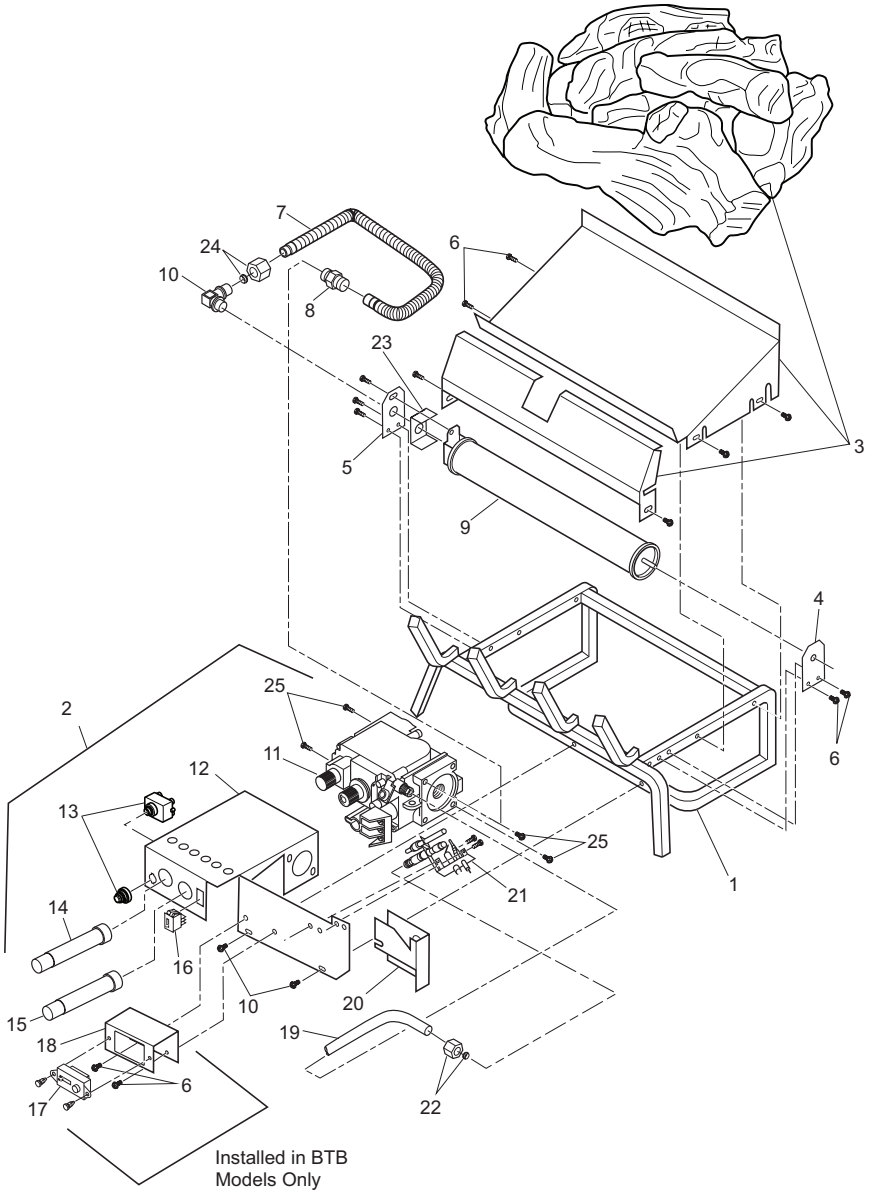

PARTS

This list contains replaceable parts used in your fireplace. When ordering parts, follow the instructions listed under Replacement Parts on page 25 of this manual.

KEY NO.	PART NO.	DESCRIPTION					QTY.
			VF18NBTB	VF18PBTB	VF24NBTB	VF24PBTB	
1	**	Grate Assembly	•	•	•	•	1
2	111794-03	Valve-Bracket Assembly	•	•	•	•	1
	111794-04	Valve-Bracket Assembly		•	•	•	1
3	120369-01	Log Assembly			•	•	1
	120368-01	Log Assembly	•	•			1
4	111803-05	Right Burner Bracket	•	•	•	•	1
5	111803-04	Left Burner Bracket	•	•	•	•	1
6	111800-01	Screw	•	•			19
	111800-01	Screw			•	•	15
7	111817-01	Flextube 3/8"	•	•	•	•	1
8	14396	Adapter	•	•	•	•	1
9	111804-04	Burner	•	•			1
	111804-03	Burner			•	•	1
10	111819-04	Elbow Orifice	•		•		1
	111819-05	Elbow Orifice		•		•	1
11	111807-01	Valve NG			•		1
	111807-02	Valve LP		•	•	•	1
12	116791-01	Valve Bracket	•	•	•	•	1
13	111435-01	Electronic Ignitor	•	•	•	•	1
14	103784-01	Control Knob Extension	•	•	•	•	1
15	103784-02	Control Knob Extension	•	•	•	•	1
16	099998-01	Fan Switch	•	•	•	•	1
17	112806-01	Remote Control Assembly	•	•			1
18	112806-02	Remote Bracket	•	•			1
19	111817-02	Flextube 3/16"	•	•	•	•	1
20	111796-02	Pilot Shield	•	•	•	•	1
21	112376-01	Pilot	•	•	•	•	1
	103778-01	Pilot		•	•	•	1
22	111828-01	Compression Nut/Sleeve	•	•	•	•	1
23	111803-03	NG Air Shutter	•	•			1
24	111824-01	Compression Nut/Sleeve	•	•	•	•	1
25	111816-01	Screw	•	•	•	•	4
PARTS AVAILABLE NOT SHOWN							
	100563-01	Warning Plate	•	•	•	•	1
	103877-01	Lighting Instruction Plate	•	•	•	•	1
	100565-01	Warning Plate Fastener	•	•	•	•	1
	100639-01	Caution Decal	•	•	•	•	1
	GA6060	Lava Rock	•	•	•	•	1
	111288-02	Gas Flex Line 18"	•	•	•	•	1
	112363-01	Log Scrap Kit #1	•	•	•	•	1
	112364-01	Log Scrap Kit #2	•	•	•	•	1

** Not a field replaceable part.

ACCESSORIES

Purchase these heater accessories from your local dealer. If they can not supply these accessories, call 1-800-655-2008 for referral information. You can also write to the address listed on the back page of this manual.

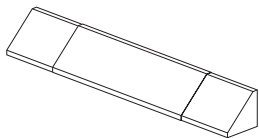

FIREPLACE HOOD

Black - GA6050

Antique Brass - GA6053

For all models. Helps deflect heat away from mantel or wall above fireplace. Fits openings 28" to 48" wide.

WALL-MOUNT ON/OFF SWITCH

GWMS2

For all models. Allows the gas log heater to be turned on and off with a wall switch.

VENT-FREE LOGMATE® FIREBOXES

Available in 32", 36", and 42" models. For all models.

DAMPER CLAMP - GA6080

For all models. Permanently opens chimney flue damper for vented operation. This is included with all models.

LAVA ROCK - GA6060

For all models. Order when additional rock is desired.

RECEIVER/REMOTE KIT - TSRC

Receiver and Touch Screen Remote Control Kit for heater rated units only.

Innovative Hearth Products Superior™ Brand Gas Log Set Limited Three Year Warranty

THE WARRANTY

Innovative Hearth Products Limited Three Year Warranty ("IHP") warrants your Superior™ brand Gas Log Set ("Product") to be free from defects in materials and workmanship at the time of manufacture. The logs and grate carry the Limited Three Year Warranty. After installation, if covered components manufactured by IHP are found to be defective in materials or workmanship during the Limited Three Year Warranty period and while the Product remains at the site of the original installation, IHP will, at its option, repair or replace the covered components. If repair or replacement is not commercially practical, IHP will, at its option, refund the purchase price or wholesale price of the IHP product, whichever is applicable. IHP will also pay IHP prevailing labor rates, as determined in its sole discretion, incurred in repairing or replacing such components. THERE ARE EXCLUSIONS AND LIMITATIONS to this Limited Three Year Warranty as described herein.

COVERAGE COMMENCEMENT DATE

Warranty coverage begins on the date of installation. In the case of new home construction, warranty coverage begins on the date of first occupancy of the dwelling or six months after the sale of the Product by an independent IHP dealer, whichever occurs earlier. The warranty shall commence no later than 24 months following the date of product shipment from IHP, regardless of the installation or occupancy date.

EXCLUSIONS AND LIMITATIONS

This Limited Three Year Warranty applies only if the Product is installed in the United States or Canada and only if operated and maintained in accordance with the printed instructions accompanying the Product and in compliance with all applicable installation and building codes and good trade practices.

This warranty is non-transferable and extends to the original owner only. The Product must be purchased through a listed supplier of IHP and proof of purchase must be provided. The following do not carry the Limited Three Year Warranty but are warranted as follows:

Gas components – Repair or replacement for one year from the date of installation.

Remote control – Repair or replacement for one year from the date of installation.

Labor coverage – Prevailing IHP labor rates apply for the warranty period of the component.

Parts not otherwise listed carry a 90 day warranty from the date of installation.

Whenever practicable, IHP will provide replacement parts, if available, for a period of 10 years from the last date of manufacture of the product.

IHP will not be responsible for: (a) damages caused by normal wear and tear, accident, riot, fire, flood or acts of God; (b) damages caused by abuse, negligence, misuse, or unauthorized alteration or repair of the Product affecting its stability or performance (The Product must be subjected to normal use. The Product is designed to burn either natural or propane gas only. Burning conventional fuels such as wood, coal or any other solid fuel will cause damage to the Product, will produce excessive temperatures and could result in a fire hazard.); (c) damages caused by failing to provide proper maintenance and service in accordance with the instructions provided with the Product; (d) damages, repairs or inefficiency resulting from faulty installation or application of the Product.

This Limited Three Year Warranty covers only parts and labor as provided herein. In no case shall IHP be responsible for materials, components or construction which are not manufactured or supplied by IHP or for the labor necessary to install, repair or remove such materials, components or construction. Additional utility bills incurred due to any malfunction or defect in equipment are not covered by this warranty. All replacement or repair components will be shipped F.O.B. from the nearest stocking IHP factory.

LIMITATION ON LIABILITY

It is expressly agreed and understood that IHP's sole obligation and the purchaser's exclusive remedy under this warranty, under any other warranty, expressed or implied, or in contract, tort or otherwise, shall be limited to replacement, repair, or refund, as specified herein.

In no event shall IHP be liable for any incidental or consequential damages caused by defects in the Product, whether such damage occurs or is discovered before or after replacement or repair, and whether such damage is caused by IHP's negligence. IHP has not made and does not make any representation or warranty of fitness for a particular use or purpose, and there is no implied condition of fitness for a particular use or purpose.

IHP makes no expressed warranties except as stated in this Limited Three Year Warranty. The duration of any implied warranty is limited to the duration of this expressed warranty.

No one is authorized to change this Limited Three Year Warranty or to create for IHP any other obligation or liability in connection with the Product. Some states and provinces do not allow the exclusion or limitation of incidental or consequential damages, so the above limitations or exclusions may not apply to you. The provisions of this Limited Three Year Warranty are in addition to and not a modification of or subtraction from any statutory warranties and other rights and remedies provided by law.

INVESTIGATION OF CLAIMS AGAINST WARRANTY

IHP reserves the right to investigate any and all claims against this Limited Three Year Warranty and to decide, in its sole discretion, upon the method of settlement.

To receive the benefits and advantages described in this Limited Three Year Warranty, the appliance must be installed and repaired by a licensed contractor approved by IHP.

Contact IHP at the address provided herein to obtain a listing of approved dealers/distributors. **IHP shall in no event be responsible for any warranty work done by a contractor that is not approved without first obtaining LHP's prior written consent.**

HOW TO REGISTER A CLAIM AGAINST WARRANTY

In order for any claim under this warranty to be valid, you must contact the IHP dealer/distributor from which you purchased the product. If you cannot locate the dealer/distributor, then you must notify IHP in writing. IHP must be notified of the claimed defect in writing within 90 days of the date of failure. Notices should be directed to the IHP Warranty Department at 1508 Elm Hill Pike, Suite 108; Nashville, TN 37210 or visit our website at WWW.SUPERIORFIREPLACES.US.COM.

KEEP THIS WARRANTY

Model (located on product or identification tag) _____

Serial No. (located on product or identification tag) _____

Date Purchased _____

Keep receipt for warranty verification.



P126857-01



1508 Elm Hill Pike, Suite 108
Nashville, TN 37210
1-800-655-2008
www.IHP.US.com

126857-01
Rev. A
02/14