



SUMMERSET
PROFESSIONAL GRILLS

LET'S GRILL.



Summerset Professional Grills strives to meet every outdoor living expression. We offer a wide range of affordable products from our Sizzler Series all the way up to our new AMG Multi Fuel Grill, without sacrificing an ounce of quality. No matter the budget, Summerset will deliver an outdoor experience that will create memories for years to come.

Here at Summerset we pride ourselves on using only the best materials. All our products are made with the highest—grade stainless steel available, designed to withstand the high temperatures and greasy environments of outdoor cooking. We strive to maintain excellence in all we do and the result is a product you can count on.

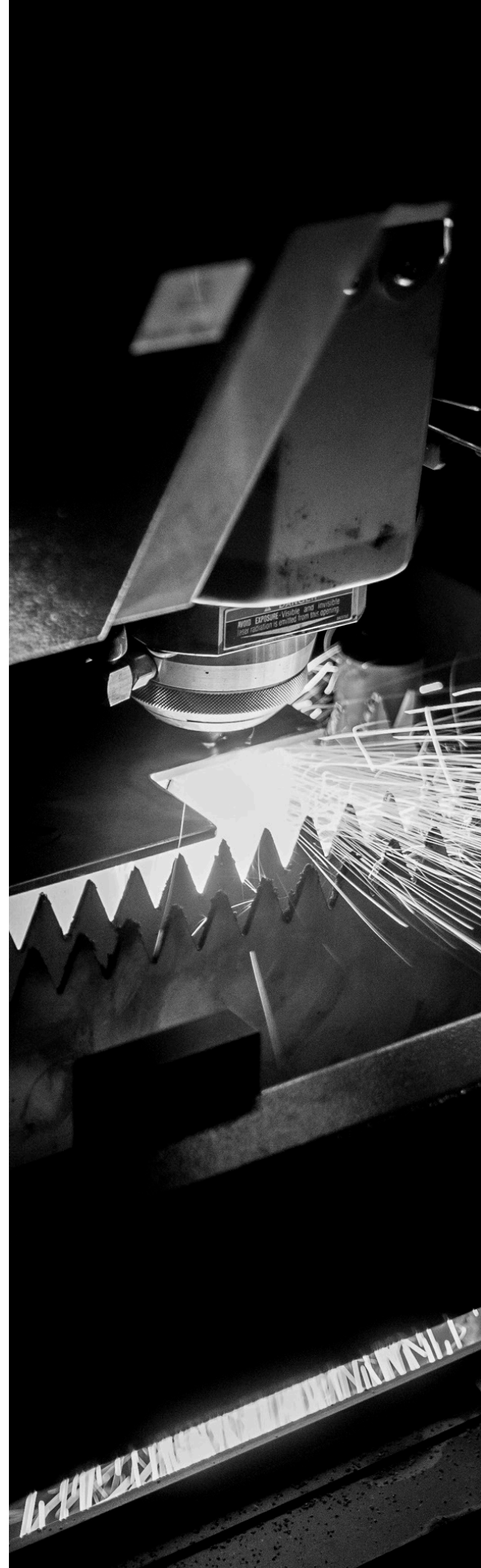

GRILLS

Summerset Professional Grills offers a complete line of stainless steel grills, grill carts, BBQ islands, fire pits, doors, drawers, components and more. Our commitment to quality is reflected in the craftsmanship of our product and is fully supported by the Summerset Warranty.

FEATURED
- AMG 36" Grill





SIZZLER

Quality you can afford. The Sizzler Series is a premium product at an unbeatable price. Constructed in all Commercial Grade stainless steel and designed with careful precision to ensure optimal airflow and even heating, this grill gives its higher—priced competitors a run for their money in both durability and grilling performance. The Sizzler will impress the most discriminating of grillers.



26" SIZZLER



32" SIZZLER



40" SIZZLER

FEATURES

- Commercial Grade Stainless Steel
- Double—Lined Hood
- 8mm Cooking Grates
- 12,000 BTU Stainless Tube Burners
- 15,000 BTU IR Back Burner
- Flame Thrower Ignition
- Manual Flash Tube Ignition
- Easy-Clean Briquette System
- Built-In and Cart Models Available
- Matching Side Burner Available
- Rotisserie Kits Available
- 15,000 BTU Drop-In Sear Burner Available
- 14,000 BTU Cast Stainless Burners Available



316

SIZZLER PRO

The Sizzler Pro Series combines features, quality construction and affordability. Based on the same sleek design of our classic Sizzler, with the addition of interior and exterior lighting, 14,000 BTU cast burners and heat zone separators, this grill really sets itself apart. The best part is... it won't break your wallet.



32" SIZZLER PRO



40" SIZZLER PRO

FEATURES

- Commercial Grade Stainless Steel
- Double—Lined Hood
- 8mm Cooking Grates
- 14,000 BTU Cast Stainless Burners
- 15,000 BTU IR Back Burner
- Heat Zone Separators
- Exterior LED Lighting
- Interior Cooking Lights
- Flame Thrower Ignition
- Manual Flash Tube Ignition
- Easy-Clean Briquette System
- Built-In and Cart Models Available
- Matching Side Burner Available
- Rotisserie Kits Available
- 15,000 BTU Drop-In Sear Burner Available



TRL/TRLD

The TRL is a fully loaded workhorse, a grilling classic packed with luxury features. Complete with interior lights, exterior LEDs, rear infrared burner, rotisserie set, flame thrower valves, easy-clean briquette burner covers and plug-and-play infrared sear zone options, the TRL makes professional grilling easy. With a commercial-grade stainless steel construction and 16-gauge stainless steel burners backed by a lifetime warranty, this grill is built to last.



32" TRL



38" TRL



44" TRLD

FEATURES

- #304 Stainless Steel
- Double-Lined Hood
- 8mm Cooking Grates
- 18,000 BTU #304 Stainless Burners
- 15,000 BTU IR Back Burner
- Flame Thrower Ignition
- Exterior LED and Interior Halogen Lighting
- Easy-Clean Briquette System
- Rotisserie Kit Included
- Heat-Zone Separators
- 18,000 BTU Drop-In Sear Burner Available
- Built-In and Cart Models Available
- Matching Sear Side Burner Available
- Matching Double Side Burner Available
- 20,000 BTU Cast Stainless Burners Available

DELUXE FEATURES

- 20,000 BTU Cast Stainless Burners
- Heavy-Duty 9mm Cooking Grates



BUILDER GRILL

The Summerset Builder grill has been specially designed to accommodate all types of multi-family and commercial applications. Whether it is an apartment community, hotel, or country club, these environments get a great deal of extra use. Donning the same beefed-up body as our luxury Alturi series, the Builder Grill is made with Commercial Grade stainless steel construction, 9mm cooking grates, and extra thick 14 gauge stainless steel burner covers. Available in both built-in and pedestal models, this grill is the perfect option for any commercial application.



BUILDER GRILL

FEATURES

- Commercial Grade Stainless Steel
- Double-Lined Hood
- Heavy-Duty 9mm Cooking Grates
- 26,000 BTU #304 Stainless Burners
- Flame Thrower Ignition
- Heavy-Duty 14 Gauge Flame Tamers
- Locking Drip Tray
- Heavy-Duty Anti-Theft Knobs
- LP Conversion Kit Included
- Built-in, Cart, and Pedestal Models Available
- Gas Timer Available



BASIC OPERATING INSTRUCTIONS

- 1. PREHEAT GRILL
- 2. PREPARE MEATS
- 3. GRILL MEATS
- 4. GRILL VEGETABLES
- 5. GRILL SEAFOOD
- 6. GRILL BREAD

ALTURI

The Alturi Series can be summed up in one word — luxury. Designed with elegance, fueled with raw power and loaded with every feature, this grill sets the bar for luxury outdoor cooking. Details like the angle-mounted interior lights, rotisserie storage and spring-assisted hood provide ultimate convenience, while its solid #304 stainless steel construction and high BTU Red Brass burners - the most durable in the market - guarantee lasting performance. When it comes to performance, quality and style, Alturi truly stands alone.



30" ALTURI



36" ALTURI



42" ALTURI

FEATURES

- #304 Stainless Steel
- Double-Lined Hood w/ Spring Assist
- Heavy-Duty 9mm Cooking Grates
- 26,000 BTU Red Brass Main Burners
- 15,000 BTU IR Back Burner
- 7,000 BTU Smoker Burner*
- Interior Halogen Lighting
- LED Front Panel Lighting
- Heat Zone Separators
- Easy-Clean Briquette System
- Flame Thrower Ignition
- Rotisserie Kit Included
- 26,000 BTU Drop-In Sear Burner Available
- Matching Sear Side Burner Available
- Matching Double Side Burner Available
- Built-In and Cart Models Available
- #304 Stainless Tube Burners Available.
- * Available in 30" and 42" Models



AMERICAN MUSCLE GRILL

We can argue all day about the convenience and consistency of gas vs. the bold flavor of charcoal. Why don't we put an end to the argument and just burn it all? Leave indecision at the door and rev-up this multi-fuel monster, enjoying the perks of gas, charcoal, wood chunks, infrared, or all of them at the same time - all in a single BBQ. Use your gas to ignite the solid fuels in just seconds, or don't. The choice is yours when you have the best of both worlds at your fingertips. With 36" and 54" models, the biggest decision you'll be left to make is how big you want it - big, or BIG.



36" AMG



54" AMG

WORKMANSHIP, FEATURES AND INNOVATION

- #304 stainless steel construction
- 16 gauge double-lined hood with spring assist
- Full width hood handle
- Hood vents for heat control
- Solid brass, flame thrower valve ignition
- 22,000 BTU main burners
- 14 gauge #304 stainless steel burners
- 12 gauge #304 burner covers
- Reversible 9 gauge v-shaped grates for cooking versatility
- Multi fuel capability
- Patented 12 gauge solid fuel trays
- Grate lifting tool for solid fuel refilling
- High efficiency interior cooking lights
- LED lights over each knob
- Easy-clean drip pan with drain system
- Built in rotisserie spit storage
- Tested to the ANSI Z21.58/ CGA 1.6
- Built, factory tested, and serviced in the USA.



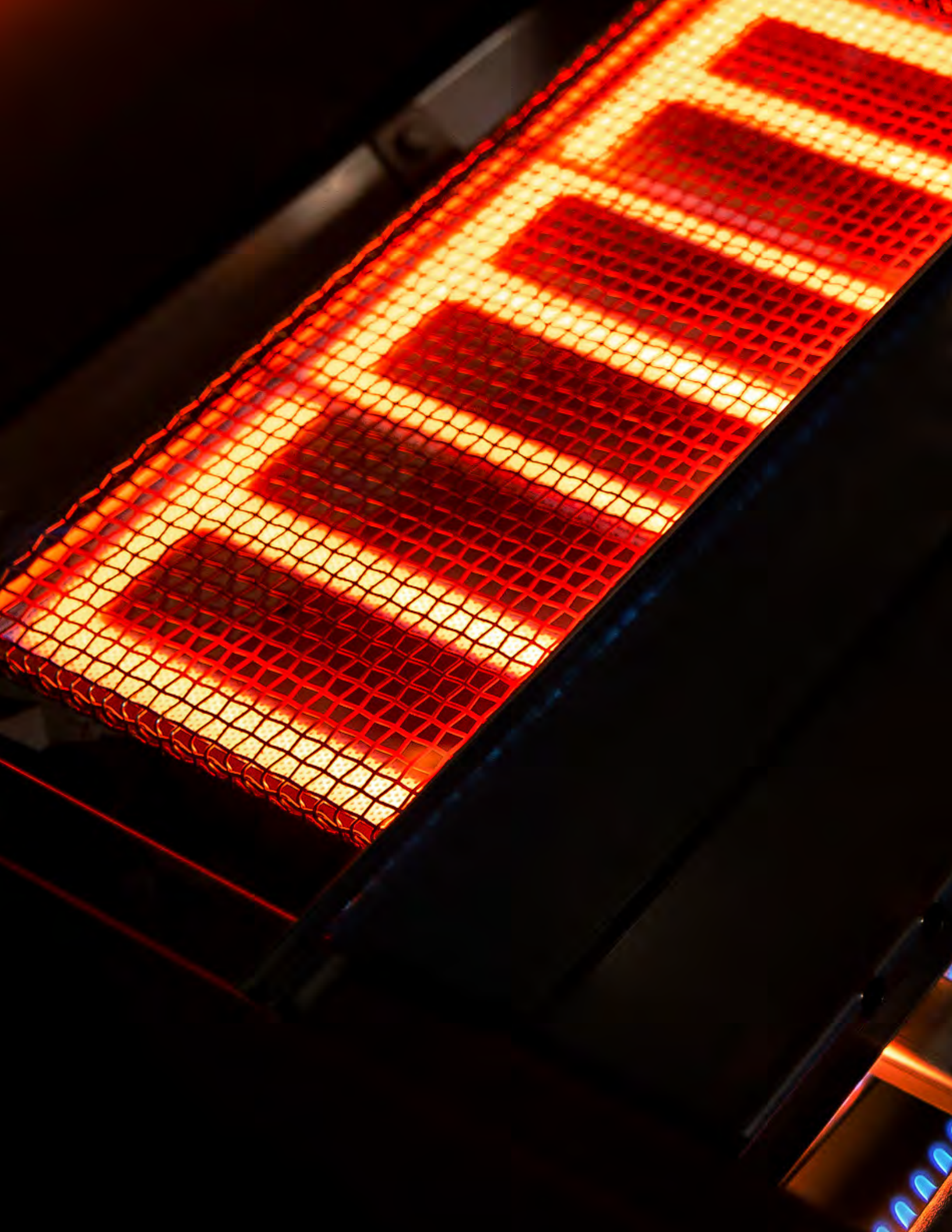



SIDE BURNERS & POWER BURNERS

Here we've combined the comfort of an indoor kitchen range with all the benefits of being outside. Specially designed for performance and function, a Summerset side burner is the perfect addition to your outdoor kitchen. Commonly used for finish cooking, sauces, or heating foods that require lower, more controlled temperatures than your grill, a side burner offers the convenience of range top cooking and grilling simultaneously. Find the perfect side burner for your outdoor kitchen with five professional lines to choose from: Sizzler, Sizzler Pro, TRL, Alturi, and AMG. All Summerset side burners feature stainless steel construction, heavy stainless steel grates, and up to 60,000 BTUs of power - all packed in a sleek design and backed by an unbeatable warranty.

FEATURED

- 36" American Muscle Grill
- AMG Power Burner
- 36" Storage Drawer







SINGLE SIDE BURNER

SSSB-1

Total BTUs: 15,000
Cooking Surface: 9¹/₂ x 9¹/₂



SIZZLER DOUBLE SIDE BURNER

SIZSB2

Total BTUs: 24,000
Cooking Surface: 19¹/₂ x 10¹/₂



SIZZLER PRO DOUBLE SIDE BURNER

SIZPRO-SB2

Total BTUs: 24,000
Cooking Surface: 19¹/₂ x 10¹/₂
Front Panel LED Lighting



TRL DOUBLE SIDE BURNER

TRLSB-2

Total BTUs: 30,000
Cooking Surface: 19¹/₄ x 11¹/₄
Front Panel LED Lighting



SEAR SIDE BURNER

SSEAR-1

Total BTUs: 26,000
Infrared Burner (Up to 1600°F)
Adjustable High/Low Technology
Cooking Surface: 18¹/₂ x 11¹/₂



**ALTURI DOUBLE
SIDE BURNER**

ALT-2B

Total BTUs: 35,000
Solid Brass Burners
Cooking Surface: 21 1/2 x 11 1/2
Front Panel LED Lighting



**ALTURI SEAR
SIDE BURNER**

ALT-SS

Total BTUs: 26,000
Infrared Burner (Up to 1600°F)
Adjustable High/Low Technology
Cooking Surface: 21 1/2 x 11 1/2
Front Panel LED Lighting



**POWER
BURNER**

TRLPB

Total BTUs: 60,000
Cooking Surface: 13 1/2 x 17 1/4
Cast Stainless Steel Dual Ring Burner
Removable Center Grate for Wok Cooking
Front Panel LED Lighting



**AMG POWER
BURNER**

AMGPB

Total BTUs: 60,000
Cooking Surface: 13 1/2 x 17 1/4
Cast Stainless Steel Dual Ring Burner
Removable Center Grate for Wok Cooking
Front Panel LED Lighting

CARTS

Summerset Professional Grills' complete line of grill carts offer a premium alternative to built-in models. Constructed of the highest quality stainless steel and manufactured in the USA, Summerset's durable carts offer stability, storage and convenience for casual and professional chefs alike.



FEATURED

- 54" AMG
- 54" AMG Cart





SUMMERSET SIZZLER CART

Commercial Grade Stainless Steel, Magnetic Double Access Door, Front Locking Caster Wheels, Interior Paper Towel Holder, Propane Tank Storage, Side, Rear and Bottom Ventilation



SUMMERSET SIZZLER PRO CART

Commercial Grade Stainless Steel, Magnetic Access Door with 2-Drawer Storage, Front Locking Caster Wheels, Interior Paper Towel Holder, Propane Tank Storage, Side, Rear and Bottom Ventilation



SUMMERSET TRL/D CART

Commercial Grade Stainless Steel, Magnetic Access Door with 2-Drawer Storage, Front Locking Caster Wheels, Interior Paper Towel Holder, Propane Tank Storage, Side, Rear and Bottom Ventilation





AMG

UNIONORA
CHARCOAL
BAR-B-Q
NATURAL
MESQUITE
CHARCOAL

100% NATURAL
MESQUITE
CHARCOAL



SUMMERSET BUILDER GRILL CART

Commercial Grade Stainless Steel, Locking Double Door, Propane Tank Storage, Side, Rear and Bottom Ventilation



SUMMERSET ALTURI CART

Commercial Grade Stainless Steel, Magnetic Access Door with 2-Drawer Storage (excludes 30"), Locking Caster Wheels, Interior Door Storage Shelves, Propane Tank Storage, Side, Rear and Bottom Ventilation



AMERICAN MUSCLE GRILL CART

Commercial Grade Stainless Steel, Large Storage Drawer With Interior Stainless Steel Fuel Dividers, Double Storage Drawers, Propane Tank Storage Drawer, Cutting Board, Cart Handle, Caster Wheels, Side, Rear and Bottom Ventilation

COLD STORAGE

Enjoy fresh ingredients and chilled beverages with Somerset Professional Grills full line of cold storage products. All Somerset refrigeration offers durable construction for the outdoors, temperature control, adjustable legs for leveling, and sleek design for function and beauty. Bring the sophistication of your indoor refrigeration systems outside with matching performance and design.

FEATURED

- Lighted Beverage Center
- 36" Double Door







A.



B.



C.



D.

REFRIGERATION

Summerset offers a wide variety of luxury stainless steel refrigerators. With up to 5.5 cubic feet of storage, these appliances will help keep your food fresh, wine chilled and beer cold, bringing the function of your indoor refrigeration outside to join the party!

A. NEW SUMMERSET REFRIGERATOR

SSRFR-S1

- Locking Door w/Reversible Door Capability
- #304 Stainless Steel Door Construction
- Rear Venting
- Storage Capacity: 4.5 ft3

B. NEW SUMMERSET DELUXE REFRIGERATOR

SSRFR-S2 / SSRFR-S2R

- Locking Door w/Reversible Door Capability
- #304 Stainless Steel Door Construction
- Rear Venting
- Storage Capacity: 4.5 ft3
- Right And Left Doors Available

C. SUMMERSET UL REFRIGERATOR

SSRFR-S3

- #304 Stainless Steel Door Construction
- Storage Capacity: 5.3 ft3
- UL Rated for Outdoor Use
- Locking Door
- Front Venting

D. SUMMERSET UL DELUXE REFRIGERATOR

SSRFR-D1

- All #304 Stainless Steel Construction
- UL Rated for Outdoor Use
- Storage Capacity: 5.3 ft3
- Locking Door
- Front Venting







E.



F.



G.



H.

**E. SUMMERSET UL KEGERATOR
W/SINGLE TAP**

SSRFR-DK1

- Storage Capacity: 6.6 ft3
- UL Rated For Outdoor Use
- #304 Stainless Steel Construction
- Locking Door
- Top Guard Rail Sold Separately
- Front Venting

**F. SUMMERSET UL KEGERATOR
W/DOUBLE TAP**

SSRFR-DK2

- Storage Capacity: 6.6 ft3
- UL Rated For Outdoor Use
- #304 Stainless Steel Construction
- Locking Door
- Top Guard Rail Sold Separately
- Front Venting

**G. SUMMERSET UL DELUXE
2-DRAWER REFRIGERATOR**

SSRFR-D2D

- #304 Stainless Steel Construction Drawers
- Storage Capacity: 5.3 ft3
- UL Rated For Outdoor Use
- Two Drawer
- Front Venting

**H. SUMMERSET UL DELUXE
WINE COOLER**

SSRFR-DWC

- Storage Capacity: 5.3 ft3
- UL Rated For Outdoor Use
- Tinted Glass
- Front Venting
- #304 Stainless Steel Door Construction
- Locking Door



SMALL ICE CHEST
SSIC-2



LARGE ICE CHEST
SSIC-1

ICE CHESTS

With our grills heating things up, we have just what you need to keep cool. Choose between two sizes to optimize your serving station. With up to 40 lbs. of ice capacity, load 'em up with refreshments, snacks or ingredients to make for a good time and easy grilling.



OUTDOOR SINK
SSNK-2

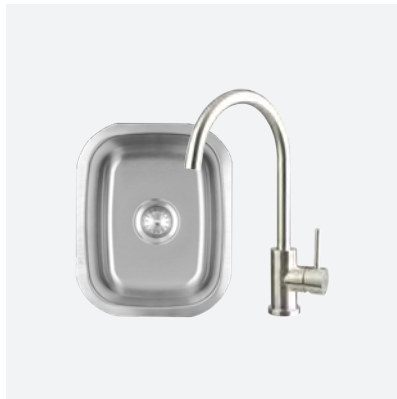

UNDER MOUNT SINK
SSNK-3

BARS AND SINKS

Take your outdoor kitchen to the next level with the Beverage Center. Complete with an ice compartment, sink, towel holder, speed rail with condiment tray and built-in bottle opener, this will make you the best host in the neighborhood. Don't worry, when the sun goes down the LEDs will light it up and keep the party going!

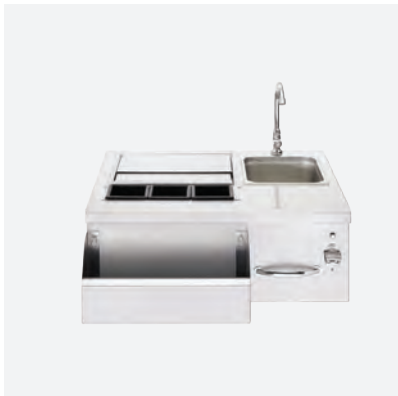

LIGHTED BEVERAGE CENTER
SSBCL



OUTDOOR KITCHEN COMPONENTS

Summerset's full line of outdoor kitchen components feature a heavy-duty flange, and soft closing drawers. Double-lined construction provides the extra insulation and resilience needed against the elements, and a thicker flange provides a sturdy, seamless fit and elegant style that will work with any counter-top and island finish. Soft closures bring the luxury of an indoor kitchen to the outdoor space. Summerset components also feature complete #304 construction, reversible door mounting, magnetic latch, smooth gliding drawers on heavy-duty tracks, and limited lifetime warranty. Sleek and seamless, Summerset components provide an integrated solution that can be personalized to any space.

FEATURED

- 36" Pantry And Door Combo

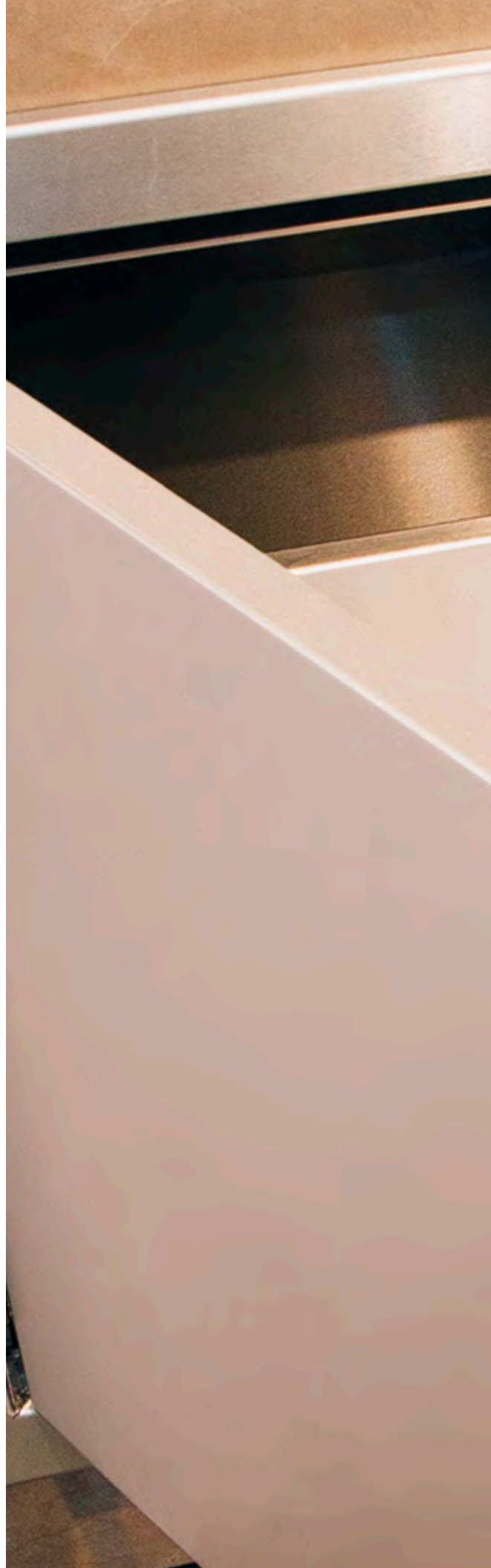





ACCESS DOORS



MINI VERTICAL DOOR
SSDV5



VERTICAL DOOR
SSDV



LARGE VERTICAL DOOR
SSDVL

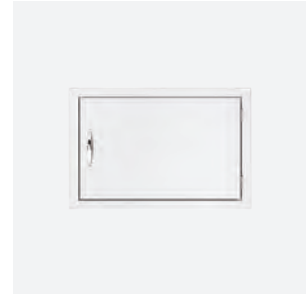

HORIZONTAL DOOR
SSDH



30", 36", 42" DOUBLE DOOR
SSDD30 / SSDD36 / SSDD42



36" AMG DOUBLE DOOR
AMGDD-36

DOOR/DRAWER COMBOS



DOOR/2-DRAWER COMBO
SSDC



LP TANK/2-DRAWER COMBO
SSLPDC



DOOR/3-DRAWER COMBO
SSDC-3



36" PANTRY AND DOOR
COMBO
SSDS-36AC



TOWEL/2-DRAWER COMBO
SSTDC

STORAGE DRAWERS



SINGLE DRAWER
SSDR1



DOUBLE DRAWER
SSDR2



TRIPLE DRAWER
SSDR3



TRASH DRAWER
SSTD



PROPANE TANK DRAWER
SSLPD



UTILITY DRAWER
SSUD



DOUBLE HORIZONTAL
DRAWER
SSHDR-2



TOWEL DRAWER
SSTDH



36" STORAGE DRAWER
AMGSD-36



36" WARMING DRAWER
SSWD36





MASONRY COMPONENTS

Summerset's line of Masonry Components are perfect for islands with stone or brick finishes. The increased flange depth makes for a seamless fit and streamlined installation. These #304 stainless steel components can also be used to add an attractive contrast to any island with stucco or Ameristone finishes.



LARGE VERTICAL DOOR
SSDVL-M



TOWEL DRAWER COMBO
SSTDC-M



TRASH DRAWER
SSTD-M



ISLAND VENT
SSIV-M



30" DOUBLE DOOR
SSDD-30M



42" DOUBLE DOOR
SSDD-42M



DOUBLE DRAWER
SSDR2-M



DOOR/2-DRAWER COMBO
SSDC-M

MADERA REAL WOOD COMPONENTS

We've recently upgraded our full line of outdoor kitchen components to feature double-lined construction, a heavier-duty flange, and soft closing drawers. Double-lined construction provides the extra insulation and resilience needed against the elements, and a thicker flange provides a sturdy, seamless fit and elegant style that will work with any counter-top and island finish. Soft closures bring the luxury of an indoor kitchen to the outdoor space. Summerset components also feature complete #304 construction, reversible door mounting, magnetic latch, smooth gliding drawers on heavy-duty tracks, and limited lifetime warranty. Sleek and seamless, Summerset components provide an integrated solution that can be personalized to any space.

FEATURED

- TRL 38"
- Madera Trash And Recycle Drawer
- 30" Madera Dry Storage Cabinet
- 20" Madera Dry Storage Cabinet







FEATURES

The Madera series relentlessly delivers in quality and performance while appearing effortless and tranquil.

#304 STAINLESS STEEL

Durability and beauty have made #304 the most appealing grade of stainless steel on the market. Found in all Summerset grills and accessories, this alloy is extremely durable, temperature resistant, and provides a beautiful finish.

CUSTOMIZABLE DESIGN

Each Madera product is designed to be personalized and tailored. Elect for our certified, sustainable teak or choose your own wood, such as ipe, mahogany, or even pine.

PATENT-PENDING CONSTRUCTION

Original and durable, each component is engineered with innovation, built to last with top-notch craftsmanship, and backed by a limited lifetime warranty.

ECO-FRIENDLY, TREATED TEAK OPTION

Bring warmth and serenity to your outdoor island with beautiful teak wood, pretreated to withstand the elements and sourced from environmentally safe sources.

DESIGNER CABINET HINGES

Each Madera cabinet features designer-grade hinges for maximum strength, function, and style. Sleek and engaging, these often unseen details further inspire and capture the attention.

WEATHER-RESISTANT SEAL

Providing longevity and peace of mind through all the seasons, each component features a weather-resistant seal to keep your island dry, clean, fresh and maintained.

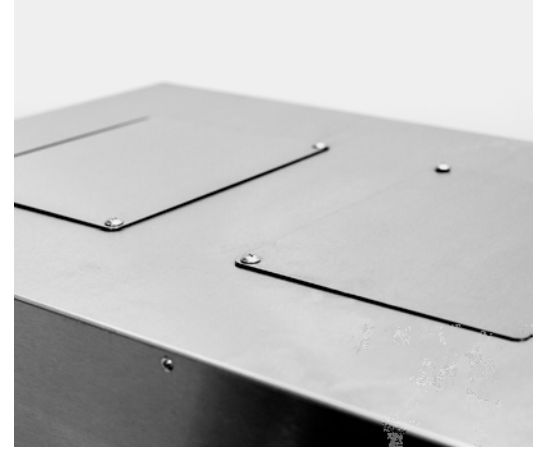

DRY STORAGE CABINETS

Madera dry storage cabinets keep your outdoor kitchen and supplies organized with multiple configurations to fit your island. Fully enclosed to keep moisture out, these cabinets offer amazing utility with matching style.



20" DRY STORAGE CABINET
SSMD-PF20



40" DRY STORAGE CABINET
SSMD-PF40



30" DRY STORAGE CABINET
SSMD-PL30

ACCESS DOORS

Madera access doors offer convenient access to your island, utilities, and grill, with matching style and warmth. With a stainless steel flange and flush mounting, these doors can be easily implemented into any design.



30" DOUBLE DOOR
SSMD-DD30



LARGE VERTICAL DOOR
SSMD-DV

FEATURES

All dry storage cabinets are fully enclosed, double-lined, have a handy magnetic latch to keep doors secure, signature flat handles, and a weather-resistant seal.

FEATURES

All doors offer easy flush mounting, a handy magnetic latch to keep doors secure, signature flat handles, and a weather resistant seal.

COMBOS

Madera combos bring the ultimate in customized storage solutions while maintaining the unified organic look. Combining the features of the dry storage cabinets and access doors into one space, the combos are ideal in smaller islands.



30" DRY STORAGE ACCESS COMBO
SSMD-DC30

FEATURES

All combos offer easy flush mounting, fully enclosed construction, a handy magnetic latch to keep doors secure, signature flat handles, and a weather-resistant seal.

DRAWERS

Madera drawers provide function and convenience for your outdoor kitchen while continuing the same matching appearance. All drawers are manufactured fully enclosed with durable, double-lined construction for maximum protection from the outdoors.



RECYCLE & TRASH DRAWER
SSMD-TD2

FEATURES

All drawers feature stainless steel mounting brackets, heavy-duty tracks, smooth gliding with soft closure, and signature flat handles.

GRILL AND ISLAND ACCESSORIES

Make your kitchen the way you want it... Somerset offers a variety of miscellaneous conveniences, upgrades, and appliances to customize your outdoor space to your liking. All products feature #304 stainless steel construction for durability and performance, matching handles and hardware, and various options.

FEATURED
- AMG Griddle





SEAR BURNERS

Become the chef you've dreamed of by using Summerset Sear Burners. Our sear burners can replace any main burner position giving you a customizable cooking experience and allowing you to burn and turn the way you want. Crank up the heat and lock in the flavor, leaving your family and friends with a meal they'll never forget.



SIZZLER SEAR BURNER
SSZ-IRB



TRL SEAR BURNER
SSIRB-L

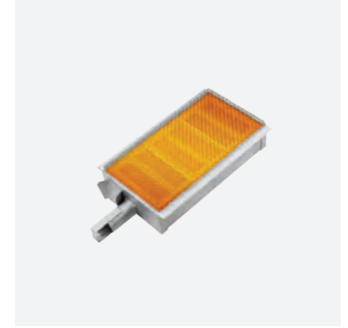

ALTURI SIDE BURNER
ALT-IRB

ISLAND ACCESSORIES

For a sleek and well finished outdoor kitchen, count on us to pay attention to even the smallest of details. Trim your refrigerator cutout, seal your umbrella hole and ventilate in style with Summerset's stainless steel accessories. Finishing touches make luxury islands!



UMBRELLA STANCHION LG/SM
SSUS-1L / SSUS-1



ISLAND VENT
SSIV-1 / SSIV-M



LARGE/SMALL SUMMERSET
FRIDGE TRIM KIT
SSRDK-S / SSRDK-L

ROTISSERIE KITS AND BAGS

The Summerset rotisserie kit will really help you take your outdoor cooking to the next level. Complete with weather-protected stainless steel motor, fork set, counter balance and a spit rod for every grill, this kit has everything you need to start cooking your chicken, turkey, loin or roast like a pro. And when you're not searing up a masterpiece, keep your kit organized and protected with the rotisserie storage bag.



SUMMERSET ROTISSERIE KITS



ROTISSERIE KIT STORAGE BAG
RSB-SM (26-32) / RSB-LG (36-44)

*Rotisserie Kit Sold Separately

SUMMERSET GRIDDLE

Breakfast, burgers, veggies, stir-fry you name it! Whatever the occasion the ALL-NEW Griddles are perfect for upgrading your grilling options! Built in the USA with #304 stainless steel, the Summerset griddle plate gives you 212 sq. in. of grilling space and the AMG griddle plate gives you an incredible 312 sq. in. of grilling space!



SUMMERSET GRIDDLE
SSGP



AMG GRIDDLE
AMGGP

GRILL COVERS

Protect your outdoor kitchen with Summerset Grill Covers. Our heavy-duty PVC covers are 100 percent water-resistant, UV-protected to prevent fading, custom fitted, and feature soft flannel backing (to keep your steel scratch-free). Covers also available for Side Burners.



GRILL COVER
GRILLCOV



CART COVER
CARTCOV

GRILL & SIDE BURNER LINERS

Summerset Grill Liners are designed with #304 exterior stainless steel construction to protect any outdoor kitchen made of combustible material. The fitted Grill Liners provide an inch of double-walled insulation that blocks the heat from reaching combustible surfaces or framing such as wood or plastic, giving you the freedom to create your outdoor kitchen in the material of your choice.



GRILL LINER



SIDE BURNER LINER

SMOKER TRAY

Add some pizzazz to an otherwise ordinary meal with the Summerset Smoker Tray. Whether it's mesquite chicken or applewood smoked salmon, the smoker tray is the ultimate meal enhancer that allows for endless flavor options.

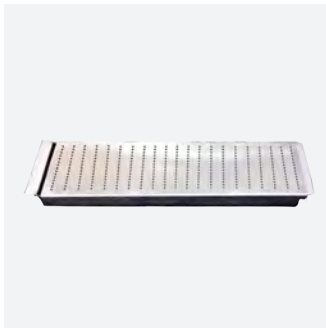

SMOKER TRAY
SSMK-SIZ / SSMK-TRL

CUTTING BOARD & TRASH CHUTE

Add convenience to your outdoor kitchen with Summerset Grills' Cutting Board & Trash Chute. Add the Trash chute above Summerset's Trash Drawer for easy cleanup. Made from #304 Stainless Steel Summerset's Trash Chute is durable even in the harshest weather.

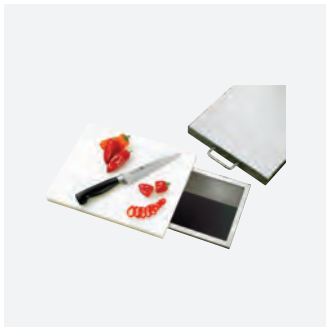

CUTTING BOARD/TRASH CHUTE
SSTC



WARRANTY

Summerset Professional Grills is backed by the strongest warranty in the industry! In addition to precision engineering and outstanding performance, Summerset grill series include a LIFETIME WARRANTY. Now you can use a grill with the peace of mind that you have an industry leading warranty.

SUMMERSET SERIES

- Lifetime warranty on construction and manufacturer defects
- Lifetime warranty on frame and housing
- Lifetime warranty on cooking grates, burners and valves
- 1 year warranty on all other parts, components, and electrical

COMPONENTS

- Limited lifetime warranty on construction, workmanship and materials for all stainless steel components, including doors, drawers, ice chests, beverage centers, sinks and grill liners
- 1 year on all other parts and electrical
- Limited (5 year) warranty on carts
- Limited (1 year) warranty on grill covers

BUILDER GRILL

1 year warranty on workmanship, construction, and manufacturer defects for all commercial and/or hospitality applications. Warranty covers all factory defects. Warranty does not cover regular cleaning, vandalism, misuse, or theft. All warranty claims are subject to manufacturer review. Warranty is valid only provided that regular maintenance is exercised. Due to the nature of commercial applications (multiple users, lack of control of use, etc.) regular maintenance is mandatory

CUTOUTS

For cutouts, dimensions or more information on your Summerset product, visit Summersetgrills.com or scan this QR Code with your smartphone's camera app.

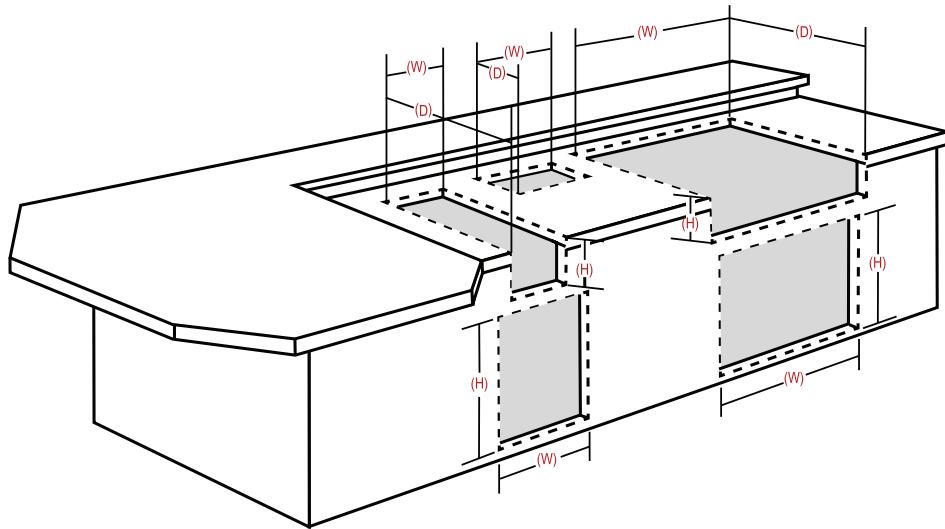

Summerset Professional Grills Warranty is valid for original purchaser at original site of delivery with proof of purchase and photo documentation only. Registration form must be submitted within 30 days of the purchase date to validate the warranty. Warranty is void upon transfer of ownership. Warranty does not apply to products installed in any commercial, rental, or non-residential application. Warranty covers replacement parts only. Manufacturer is not responsible for labor or labor-related costs. Warranty does not cover discoloration, surface rust, corrosion, or oxidation, which may occur due to harsh environments, chemicals, or overheating. Warranty will not apply for damage resulting from improper installations, abuse, extreme environments, grease fires, or misuse. Regular and proper maintenance is required. Coastal, humid, and/or salt environments are subject to manufacturer review. All out-of-box claims must be made within 30 days of purchase and must be made prior to installation. Any product installed damaged will be considered damaged during installation and not covered under warranty. Warranty and registration forms are available at www.SummersetGrills.com. Please be advised - all display models are sold "as is" and the warranty covers the following items only: main burners (lifetime), grates (lifetime), burner covers (1 year). All warranties are subject to the review and approval of the manufacturer.



SCAN HERE

SUMMERSET PROFESSIONAL GRILLS
17322 GOTHARD STREET, HUNTINGTON BEACH CA, 92647 (800) 966-8126 SUMMERSETGRILLS.COM