



VRB46

DIRECT VENT GAS FIREPLACE



THE ULTIMATE IN DESIGN, ENGINEERING & QUALITY

Unit Illustrated is a VRB46N Zero Clearance Direct Vent Gas Fireplace – Natural Gas, ZRB46PL Porcelain Liners, and V46EG Enclosure Grill.



The ultimate in Zero Clearance Direct Vent Fireplaces for new home construction or renovation, and your best choice for installation anywhere throughout your home.

VRB46

DIRECT VENT GAS FIREPLACE



Unit Illustrated is a VRB46N Zero Clearance Direct Vent Gas Fireplace – Natural Gas, ZRB46S1SS Surround Stainless Steel, RBCB1 Cannonballs x 14, and ZRB46PL Porcelain Liners.



Unit Illustrated is a VRB46N Zero Clearance Direct Vent Gas Fireplace – Natural Gas, and ZRB46PL Porcelain Liners.

STANDARD FEATURES

- Hi/Low Millivolt or IPI valve system will operate during power failures.
- Decorative Bronze Glass
- Mobile Home, Bedroom and Bed Sitting Room approve
- Safety Screen Barrier*

OPTIONAL FEATURES

Fan Kit

Heat activated with variable speed control

Wall Mount Thermostat

Standard On/Off or Programmable 5 day (weekday) and 2 day (weekend)

Remote Control

On/Off, Thermostat On/Off, Thermostat On/Off modulating, Thermostat On/Off modulating and fan control

Universal Light Kit

Accent Lighting – Two Lamps

Porcelain Reflective Liner

Cannonballs

Enclosure Grill



Safety Screen Barrier

*All gas fireplaces manufactured as of January 1, 2015 include a Safety Screen Barrier.



THE ULTIMATE IN DESIGN, ENGINEERING & QUALITY

Model	VRB46N/NE	VRB46LP/LPE
Fuel	Natural	Propane
Gas Control	Millivolt / IPI	Millivolt / IPI
Input Max.	23,250 BTU	23,250 BTU
Input Min.	15,750 BTU	17,750 BTU
FE (P.4.1-02)	73.1% / 77.4%	75.7% / 80.3%
Glass Size	40 5/8" x 13 7/8"	40 5/8" x 13 7/8"
Venting	4/7" Kingsman Flex Vent Only	

Warm up your favourite room with the beauty of a Linear Fireplace.

VENTED CHASE OPTION

When installing a TV above the fireplace, Cool Touch Walls, or reduced Mantel Clearances, the chase of the fireplace must be vented. This can be done by either installing a grill on the front of chase or side grills (for a chase that bumps out in to a room) or be open at the top of the chase. (See illustrations and manual for further information).

Minimum enclosure height for a vented chase is 70" from bottom of fireplace, ventilation of a 105 in² of minimum free air opening is required. Choose between our V46EG Enclosure Grill or Custom Grill (if custom grills are used the louvers cannot slope) or adequate ventilation opening as stated in the manual. Grill or opening must be within 2" of chase top/ceiling.

NOTE: To vent the fireplace chase, removal of vent shields from the fireplace is required.

Framing to ceiling with open front 2-1/4" x 47"

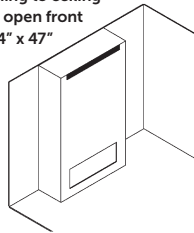

Open chase framing with enclosure min 1-1/4" below ceiling

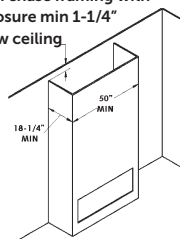

Framing to ceiling with vents at front and back

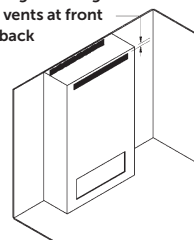

Framing to ceiling with front or side vents

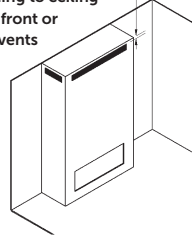

Framing to ceiling, minimum enclosure with front or side vents

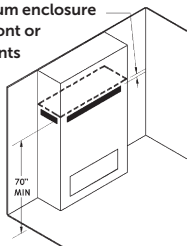

Minimum enclosure with front or side vents

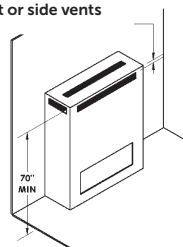

Minimum enclosure with front and back vents

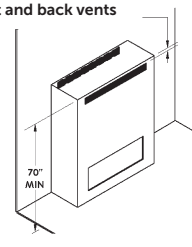

1.



2.



3.



4.

SURROUND & ENCLOSURE GRILL SIZES

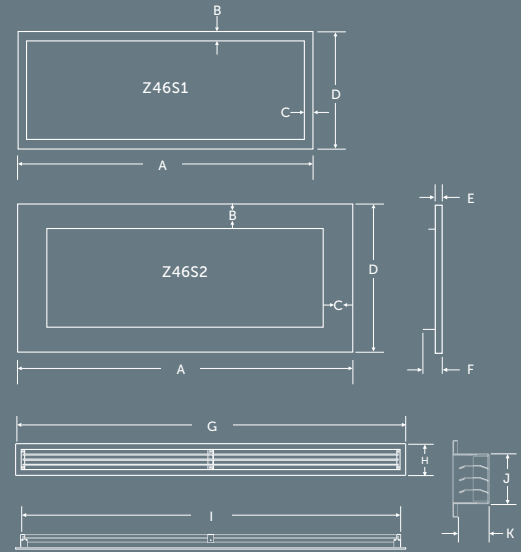

	Surrounds		Grill	
	Z46S1	Z46S2	V46EG	
A	44 5/8"	50 3/8"	G	47 13/16"
B	1 1/2"	4 7/8"	H	3 13/16"
C	1 1/2"	4 7/8"	I	46 9/16"
D	17 3/4"	22 1/2"	J	2 1/2"
E	1"	1"	K	1 9/16"
F	1 3/4"	1 3/4"		

SPECIFICATIONS (IN.)

FIREPLACE DIMENSIONS

	Width	Height	Depth
VRB46	46 1/4"	43 1/2"	17 7/8"

FRAMING DIMENSIONS

	Width	Height	Depth
VRB46	47"	43 3/4"	18 1/4"

- Unit Illustrated is a VRB46N Zero Clearance Direct Vent Gas Fireplace – Natural Gas, ZRB46S2BL Surround Stainless Steel, and ZRB46PL Porcelain Liners.
- Unit Illustrated is a VRB46N Zero Clearance Direct Vent Gas Fireplace – Natural Gas, ZRB46S1BL Surround Black, and ZRB46PL Porcelain Liners.
- Unit Illustrated is a VRB46N Zero Clearance Direct Vent Gas Fireplace – Natural Gas, ZRB46S1BL Surround Black, RBCB1 Cannonballs x 14, and ZRB46PL Porcelain Liners.
- Unit Illustrated is a ZRB46N Zero Clearance Direct Vent Gas Fireplace – Natural Gas, ZRB46S1SS Surround Stainless Steel, and ZRB46PL Porcelain Liners.



2340 Logan Avenue
Winnipeg, Manitoba, Canada R2R 2V3
Phone: (204) 632-1962 Fax: (204) 632-1960
www.kingsmanfireplaces.com

VRB46

DIRECT VENT GAS FIREPLACE



*Components may have to be ordered separately to create a complete unit. Discuss with your local Kingsman dealer for clarification.

Kingsman Fireplaces maintains a program of continuous testing, refinement and improvements of all its products. Some aspect of units shown here may be changed at any time without notice or obligation.
Certification: Model VRB46 is certified to ANSI Z21.88-2016, CSA 2.33-2016, CGA 2.17-M91 (R2014) vented gas fireplace heater.